

H8

Handy Recorder

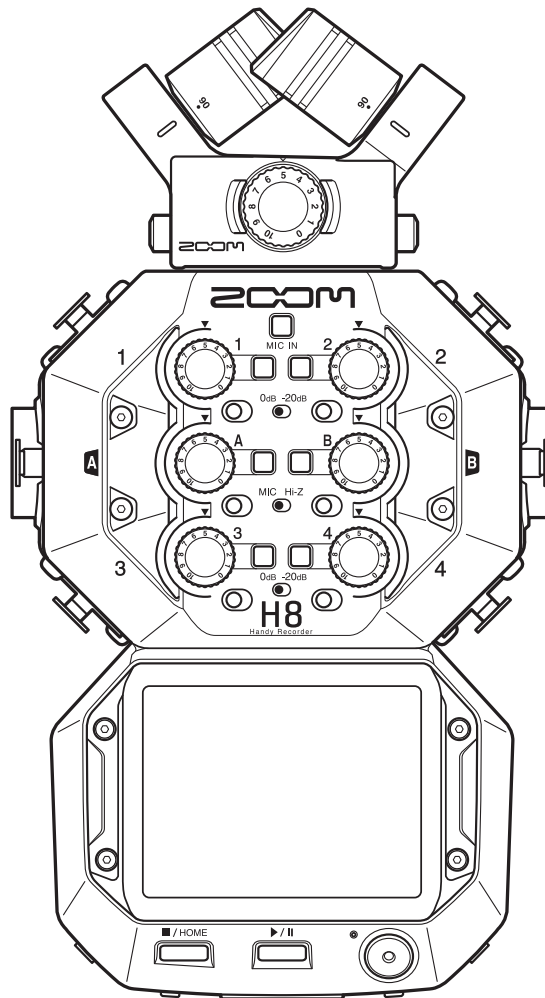

Operation Manual

You must read the Usage and Safety Precautions before use.

© 2021 ZOOM CORPORATION

Copying or reprinting this manual in part or in whole without permission is prohibited.

Product names, registered trademarks and company names in this document are the property of their respective companies. All trademarks and registered trademarks in this document are for identification purposes only and are not intended to infringe on the copyrights of their respective owners.

Proper display is not possible on grayscale devices.

Notes about this Operation Manual

You might need this manual in the future. Always keep it in a place where you can access it easily. The contents of this document and the specifications of the product could be changed without notice. Items that appear on the touchscreen are shown with a gray background in this operation manual.(Example: Lo Cut)

- © Windows® is a trademark or registered trademark of Microsoft® Corporation.
- © macOS and iPadOS are trademarks or registered trademarks of Apple Inc.
- © The SD, SDHC and SDXC logos are trademarks.
- © The Bluetooth® word mark and logo are registered trademarks of Bluetooth SIG, Inc. and these marks are used under license by Zoom Corporation. Other trademarks and trade names are the property of their respective companies.
- © Other product names, registered trademarks and company names in this document are the property of their respective companies.
 - All trademarks and registered trademarks in this document are for identification purposes only and are not intended to infringe on the copyrights of their respective owners.
 - Recording from copyrighted sources, including CDs, records, tapes, live performances, video works and broadcasts, without permission of the copyright holder for any purpose other than personal use is prohibited by law. Zoom Corporation will not assume any responsibility related to infringements of copyrights.
- © Google Spatial Audio HRIRs
Copyright 2016 Google Inc. All Rights Reserved.
This product includes HRTFs (Head Related Impulse Responses) developed by Google Inc.
Google Spatial Audio is released under Apache License 2.0.
<http://www.apache.org/licenses/LICENSE-2.0>

THESE HRTFs WERE MODIFIED BY ZOOM.

length: first 64 samples

filter: low shelf

Introduction

Thank you very much for purchasing the ZOOM **H8** Handy Recorder.

The **H8** portable recorder can handle all kinds of recording with three apps (FIELD, MUSIC, PODCAST) that can be selected according to the type of project, an extensive selection of input options, and a touchscreen that allows intuitive operation. We hope you will enjoy using it for a long time.

Main features of the **H8**

FIELD app

This field recording app, which can record up to 12 tracks, is designed for capturing sound in the environment and for the creation of movies and television shows, for example. In addition to a large meter display that makes checking track levels easy, this app offers a low-cut filter, compressor, limiter, noise gate and other signal processing along with a sound marker function that is useful for synchronizing camera video.

MUSIC app

This app enables multi-track recording of even large bands with up to 10 inputs (using an optional EXH-8). Level meters and faders, which are crucial in music production, are located on the Home Screen. This recording app offers significant features, including equalization, compression and other dynamics signal processing on each channel as well as punching in and out, which enables rerecording parts. Moreover, the included effects are equivalent to those in ZOOM multi-effects processors. By connecting to Guitar Lab over USB, a massive library of amp/cabinet models and effects can be accessed.

PODCAST app

This app turns the **H8** into a portable podcast recorder. By tapping the four sound pads located on the Home Screen, effect sounds and jingles can be played to add excitement to programs (and recorded on tracks 3/4 and the stereo mix). In addition to the 13 preset sounds, any samples on the SD card can be assigned to the sound pads. Using the function that enables simultaneous recording of stereo mix files, podcast files can be created using just the **H8**.

Optional mic capsules

The **H8** has a unique ZOOM mic capsule connector that allows mic capsules to be switched for different applications. In addition to the included XYH-6 XY stereo mic, the MSH-6 MS mic and other existing optional capsules be used. Furthermore, the **H8** also supports a new generation of capsules, including the XAH-8 mic that can be switched between XY to AB patterns, the VRH-8 Ambisonic mic capable of recording 360° sound and the EXH-8 attachment with 4 XLR jacks.

Extensive selection of input options

In addition to the mic capsule connector (MIC IN), the **H8** has XLR jacks (Inputs 1–4) and TRS/XLR combo jacks (Inputs A and B) built in. Inputs 1–4 support professional mixer output using the –20dB PAD function. In addition, Inputs A and B support Hi-Z, enabling direct input of guitars and basses.

Remote operation using iOS/iPadOS devices

Using an optional wireless adapter (BTA-1) and the **H8** Control iOS/iPadOS app enables operation of the **H8** from a distance, eliminating concern about handling noise from direct operation of the unit.

Audio interface use with computers and iOS/iPadOS devices

Connected to a computer or iOS/iPadOS device by USB, the **H8** can be used as an audio interface with up to 12 tracks for music production in a DAW or for online meetings.

Terms used in this manual

Effect

A wide variety of effects can be applied to sounds, including distortion, chorus and reverb. By adjusting effect parameters, you can create your own original sounds.

Patch memory

Patch memories store the effects used, their ON/OFF states and parameter setting values, allowing easy recall. Effects are saved and recalled in units of patch memories. Up to three effects can be added to one patch memory, and the **H8** can store up to 50 patches.

Automatic saving

This function automatically saves changes to patch memories and effect settings.

Sound pad

Sound pads can be pressed to play the audio files that have been assigned to them. This is convenient for playing interviews that have been recorded in advance, opening and closing music and jingles.

Project

The **H8** manages recording and playback data in units called projects.

The audio files assigned to tracks and settings, including for panning, faders and marks, are saved in project files. Up to 999 projects can be created on a single card.

Contents

Notes about this Operation Manual	2	Recording with the MUSIC app	59
Introduction	3	Display overview	59
Terms used in this manual	4	Creating new projects	61
H8 overview	7	Opening existing projects.....	63
H8 apps	7	Recording.....	65
Functions of parts	8	Playing recordings	67
Mic capsule overview	12	Using effects.....	68
Touchscreen operation overview	13	Using the metronome	69
Making preparations	16	Assigning files to tracks.....	74
Inserting SD cards	16	Recording additional files.....	78
Supplying power	17	Mixing projects	80
Turning the power on/off	18	Recording with the PODCAST app	83
Preventing misoperation (HOLD function)	18	Display overview	83
Setting the display language (first time starting up)	19	Recording.....	85
Setting the date and time (first time starting up)	19	Playing recordings	86
Connecting	20	Using sound pads	88
Connection examples	20	Making recording settings	91
Connecting/disconnecting the mic capsule	21	Using effects	95
Connecting mics, instruments, mixers and other equipment	23	Selecting tracks and patch memories to use effects	95
Making input and output settings	25	Adjusting effect parameters	100
Making settings for input tracks	25	Making patch memory settings	101
Setting the headphone output level	42	Managing projects	106
Adjusting connected equipment levels (playing test tones)	43	Folder and file structure.....	106
Recording with the FIELD app	45	Managing projects	107
Display overview	45	Using as an audio interface	112
Recording.....	47	Connecting the H8 with a computer or iOS/iPadOS device	112
Playing recordings	49	Disconnecting from a computer or iOS/iPadOS device	114
Recording automatically	50	Making audio interface settings	115
Capturing audio before recording starts (pre-recording)	54	Managing SD cards	117
Enabling the sound marker function	56	Checking SD card information.....	117
Recording L/R tracks	57	Testing SD card performance	118
		Formatting SD cards	121
		Using as a card reader	122
		Connecting the H8 with a computer	122
		Disconnecting a computer from the H8	123

Using the tuner	124
Tuning guitars	124
Changing the tuner type.....	125
Setting the standard pitch of the tuner	126
Using flat tunings	128
Using Guitar Lab	130
Connecting Guitar Lab.....	130
Disconnecting Guitar Lab	130
Setting the date and time	131
Setting the date and time	131
Setting the date format	132
Setting the battery type	134
Setting how marks are added when recording/playing	135
Making display settings	136
Setting the display brightness	136
Setting the display backlight	137
Setting the Auto Power OFF function	139
Operating from an iOS/iPadOS device	141
Connecting an iOS/iPadOS device	141
Disconnecting from an iOS/iPadOS device.....	143
Setting the language shown.....	144
Restoring default setting values	145
Managing the firmware	146
Checking the firmware versions.....	146
Updating the firmware	146
Using optional mic capsules	147
Using the XAH-8.....	147
Using the EXH-8.....	150
Using the VRH-8.....	154
Appendix	160
Troubleshooting.....	160
Specifications	162

H8 overview

H8 apps

The **H8** includes three apps that are tailored for different uses and can be launched from its Home Screen.

FIELD app

Use this for field recording. This can be used to record things that can be heard in nature to realize unique sounds for effects.

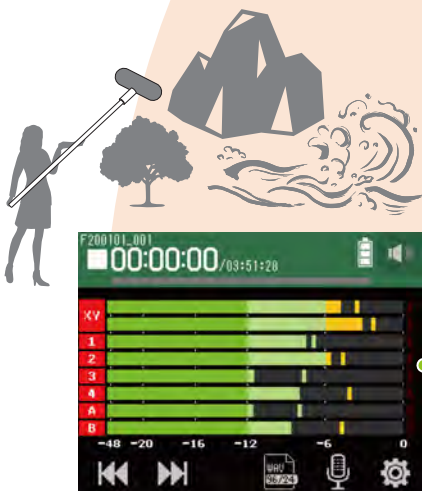

PODCAST app

This app is good for preparing audio materials for podcasts as well as live streaming. Content can be made that is easy to listen to casually on smartphones, computers and other devices.



Home Screen

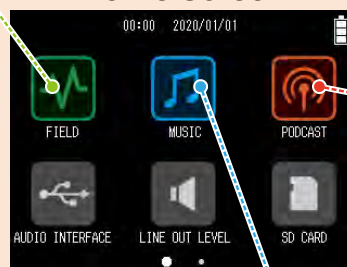

MUSIC app

Use this when making music. Guitar can be recorded while listening back to previously recorded drum tracks, and vocals can be rerecorded as many times as necessary until everyone is satisfied.



Functions of parts

Front

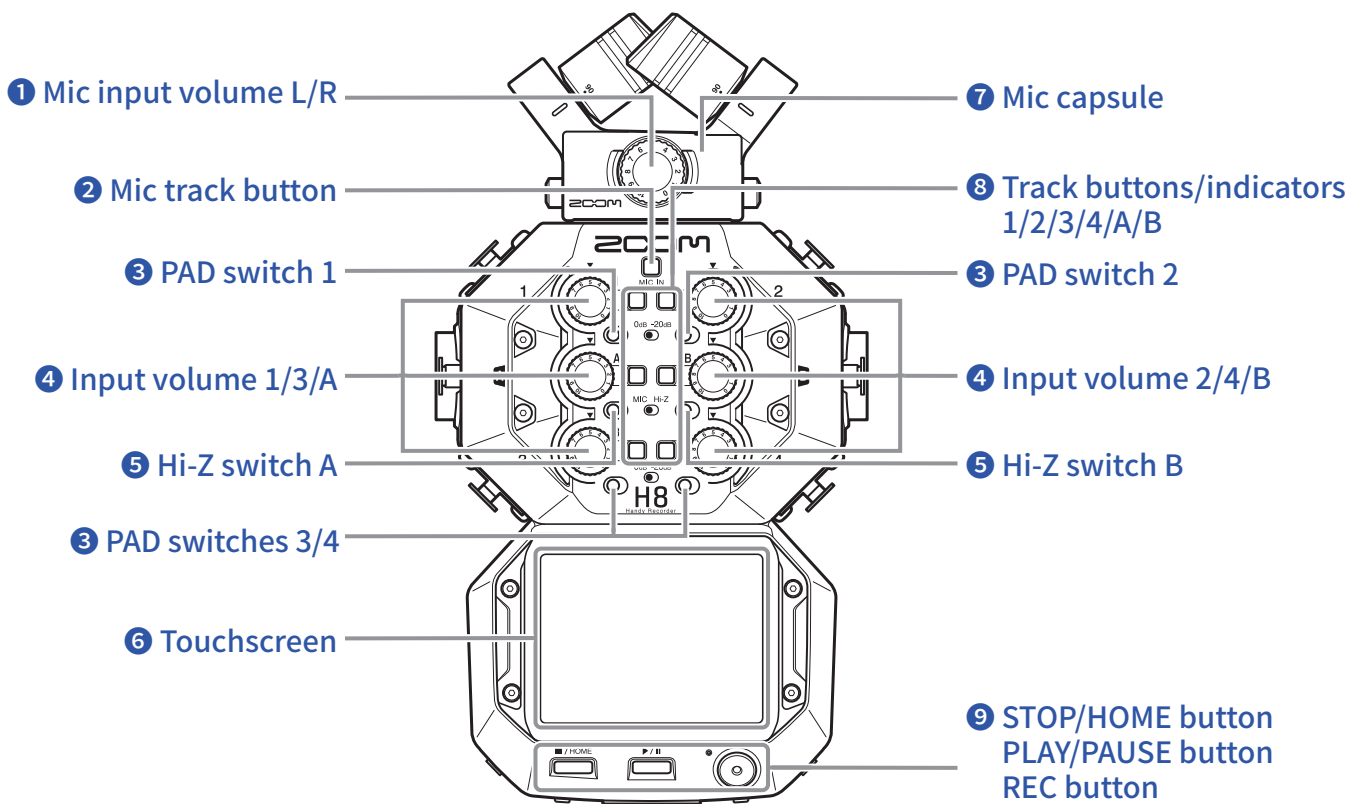

1 Mic input volume L/R

Use to adjust the mic input volume.

2 Mic track button

This turns the mic track on and off.

3 PAD switches 1-4

These attenuate (reduce) the input signals of equipment connected to inputs 1-4 by 20 dB. Set PAD switches to [-20dB] when connecting line level equipment.

4 Input volume knobs 1/2/3/4/A/B

Use to adjust input volumes.

5 Hi-Z switches A/B

Use to switch the impedances of inputs A/B.

Set Hi-Z switches to [Hi-Z] when connecting a guitar or bass guitar.

6 Touchscreen

This shows various types of information and allows touch control of unit settings and other features.

7 Mic capsule

This can be swapped for different applications.

8 Track buttons/indicators 1/2/3/4/A/B

These turn input tracks on and off.

They also light red and green to show track status. They blink rapidly when input sound levels are high.

9 STOP/HOME button

Press to stop project recording/playback and to open the Home Screen or the top screen of an app.

PLAY/PAUSE button

Press to start/pause playback of recorded projects.

REC button

Press to start recording.

Left side

Right side

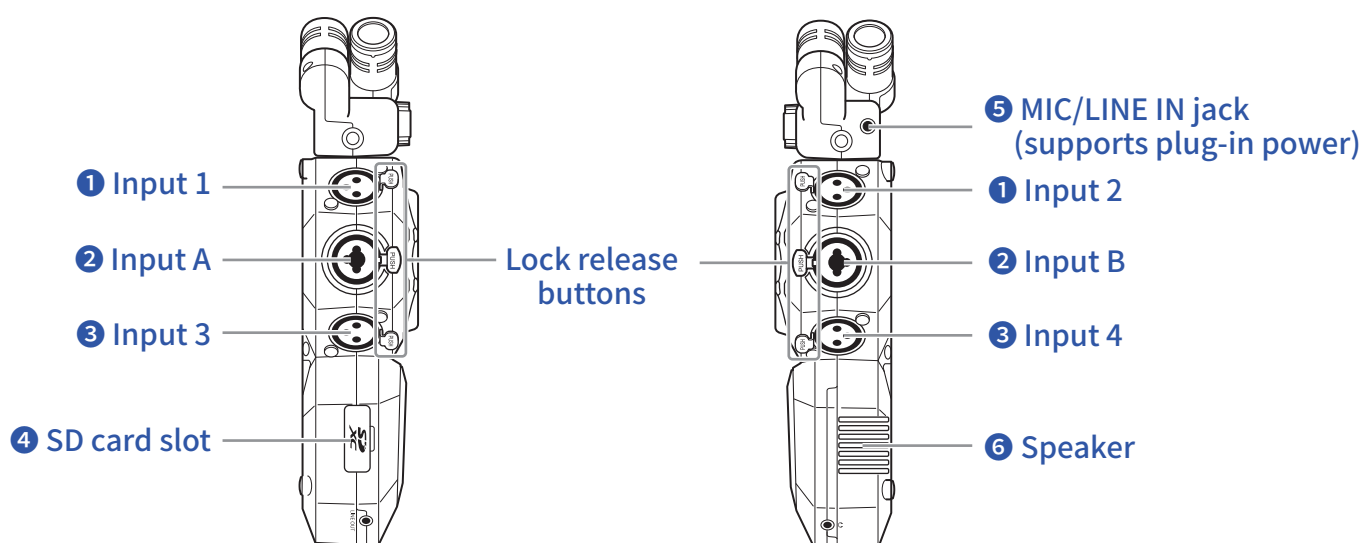

1 Inputs 1/2

Connect mics and keyboards to these. These support XLR Plug connectors.

2 Inputs A/B

Connect mics, keyboards and guitars to these. These support XLR and 1/4-inch phone (unbalanced) plugs.

3 Inputs 3/4

Connect mics and keyboards to these. These support XLR Plug connectors.

4 SD card slot

The **H8** supports cards that conform to SD, SDHC or SDXC specifications.

5 MIC/LINE IN input jack (supports plug-in power)

A connected mic can be used to record. Mics that require plug-in power can be used with this jack.

6 Speaker

Sound is output here during project playback.

Bottom

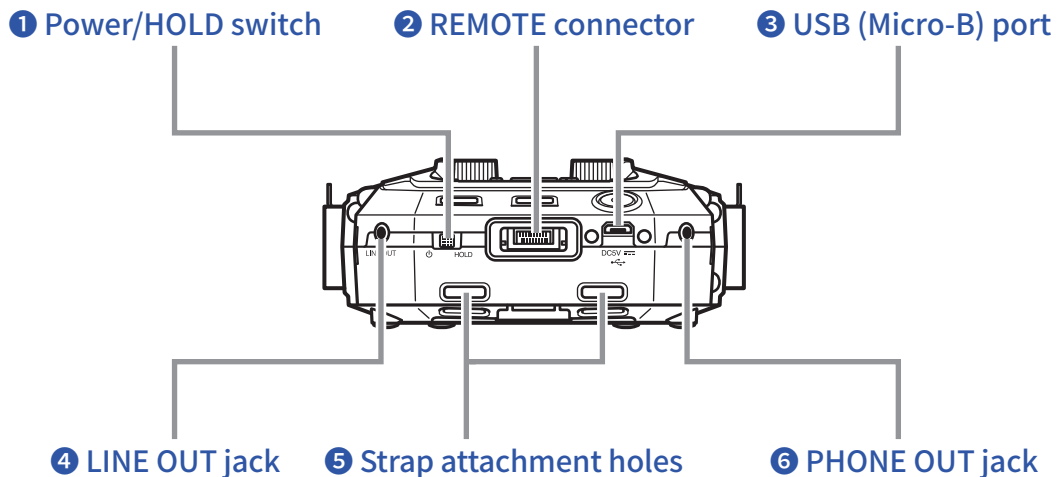

1 Power/HOLD switch

Use this to turn the power ON/OFF and to disable button operation.

2 REMOTE connector

Connect a BTA-1 or other dedicated wireless adapter here. This enables operation of the **H8** from an iOS/iPadOS device using a dedicated controller app.

3 USB (Micro-B) port

Connect this to a computer or iOS/iPadOS device to use the **H8** as an audio interface or card reader. By using Guitar Lab on a computer, you can also manage patches and edit and add effects, for example. A dedicated AC adapter (ZOOM AD-17) can also be connected here to use AC power.

4 LINE OUT jack

This can output sound to a connected device.

5 Strap attachment holes

Use these to attach a strap.

6 PHONE OUT jack

This can output sound to headphones.

■ Back

① Mic connector cap attachment points

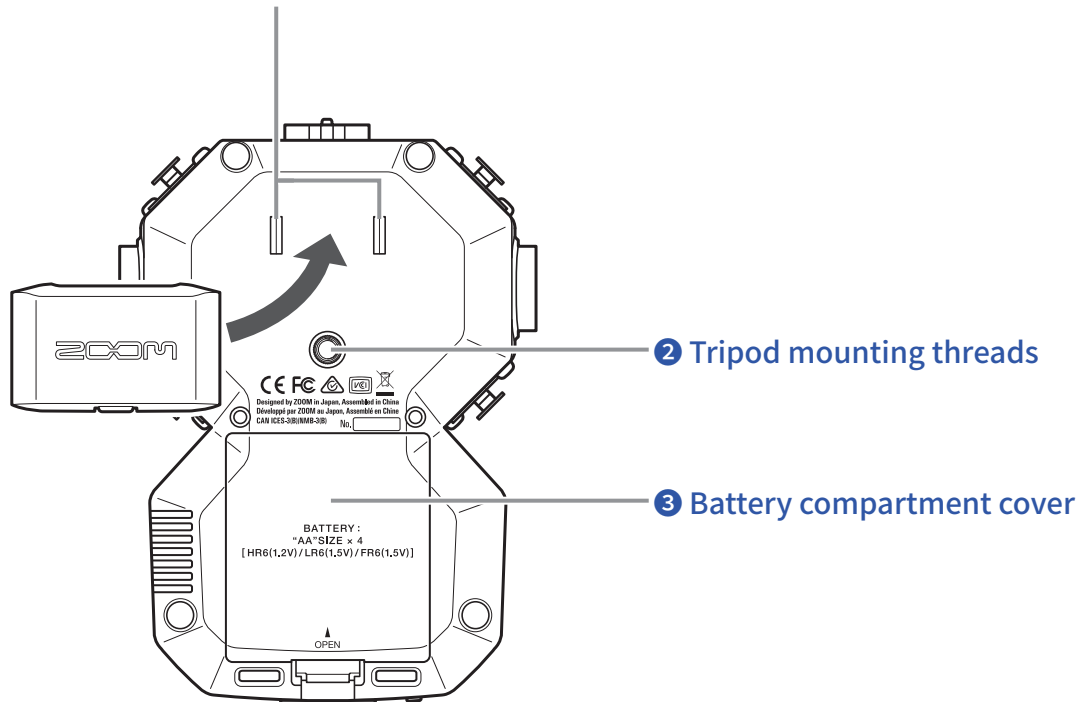

① Mic connector cap attachment points

Use these when attaching a mic connector cap.

② Tripod mounting threads

Use these screw threads to attach a tripod (not included).

③ Battery compartment cover

Remove when installing or removing batteries.

Mic capsule overview

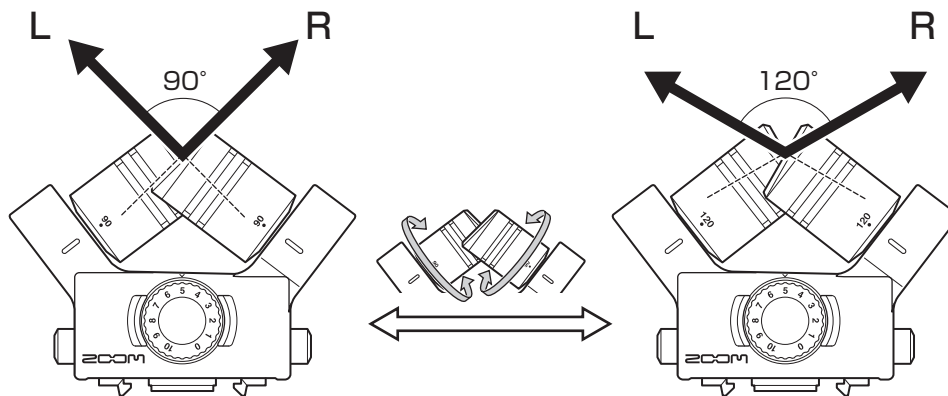

The **H8** includes a mic capsule (XY mic).

The XY mic capsule has two crossing directional mics. By rotating the individual mics, the width of audio capture can be switched from 90° to 120°.

Features:

Since these mics have large diaphragms, they can record a range of frequencies from low to high with good stereo placement while capturing sounds in the center clearly.

Providing a three-dimensional sound with natural depth and width, this technique is ideal for recording when you want to capture a specific sound source that is nearby or at a medium distance.

Use examples: solo performances, chamber music, live rehearsals, field recording

NOTE

The XY mic has a MIC/LINE IN input jack that can be used to connect an external mic or line-level device. This jack can also provide plug-in power to mics that use it. (→ [page 28](#))

Touchscreen operation overview

Tap, swipe and slide on the **H8** touchscreen to make settings and select functions to adjust.

Home Screen

This appears on the touchscreen when the **H8** power is turned on.

From the Home Screen, three recording applications, various settings screens and other functions can be launched.



- Tap the  icon to launch the FIELD app.



- Tap the  icon to launch the MUSIC app.

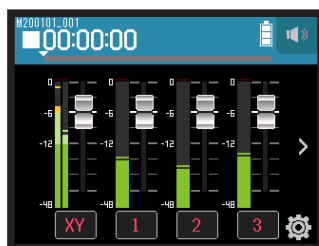

- Tap the  icon to launch the PODCAST app.



- Tap other icons to launch various settings screens, for example.

HINT

Press  to return to the Home Screen.

Operations on various screens

Tap, slide and swipe to operate the touchscreen.



Tap
(touch a selection item)

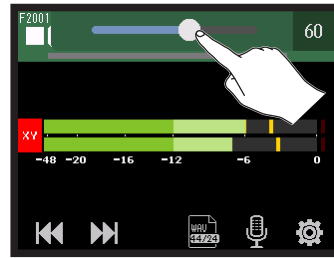

Slide
(move while touching)



Swipe
(flick finger left or right while touching)

Character Input Screen overview



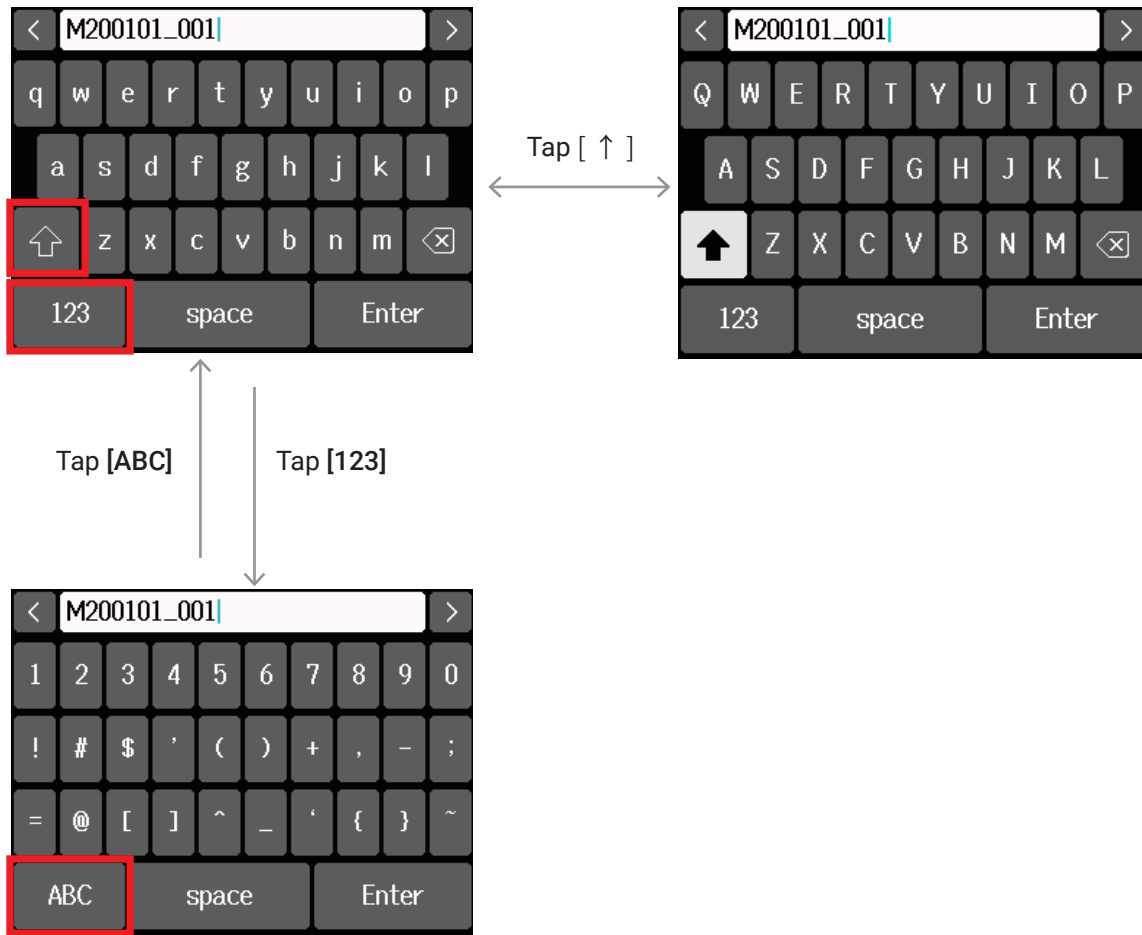

NOTE

The following characters can be used in project names.
(space)!#\$'()+,-0123456789;=@ABCDEFGHIJKLMN OPQRSTUVWXYZ[]^_`abcde
fghijklmnopqrstuvwxyz{ }~

Making preparations

Inserting SD cards

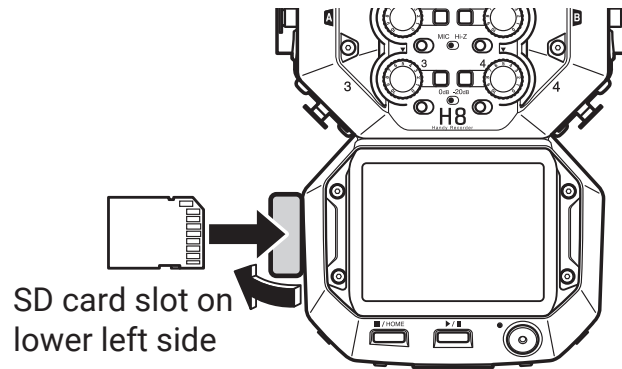

1. Turn the power off and then open the SD card slot cover.
2. Insert the SD card into the SD card slot.

To remove an SD card, push it further into the slot and then pull it out.

NOTE

- Always turn the power off before inserting or removing an SD card. Inserting or removing a card while the power is on could result in data loss.
- When inserting an SD card, be sure to insert the correct end with the top side up as shown.
- If an SD card is not loaded, recording and playback are not possible.
- After purchasing a new SD card, always format it using the **H8** to maximize performance. (→ ["Formatting SD cards" on page 121](#))

Supplying power

Using batteries

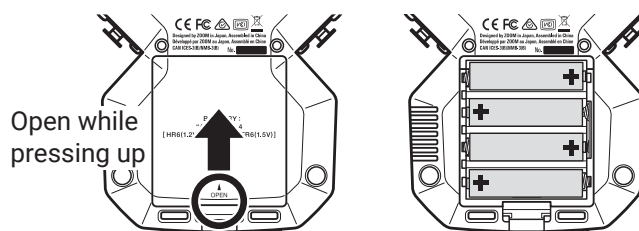

1. Turn the power off and then remove the battery cover.
2. Install the batteries.
3. Replace the battery cover.

NOTE

- Use alkaline batteries, rechargeable NiMH batteries or lithium batteries.
- If the battery indicator becomes empty, turn the power off immediately and install new batteries.
- To enable accurate display of remaining battery charge, set the battery type using Home Screen > SYSTEM > Battery. (→ [“Setting the battery type” on page 134](#))

Using an AC adapter

1. Connect the cable of the dedicated ZOOM AD-17 AC adapter to the USB port.

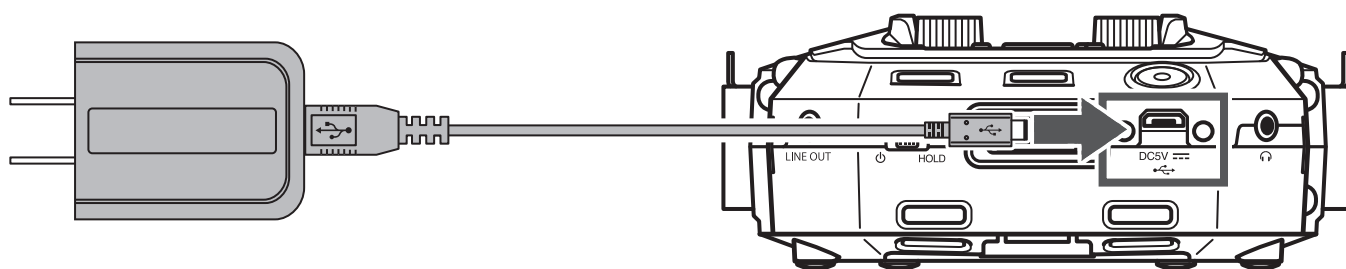

2. Plug the dedicated AC adapter into an outlet.

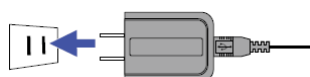

HINT

- A 5V mobile battery (commercially-available) can also be connected.
- When connected to a computer, power can be supplied by USB.

Turning the power on/off

Turning the power on

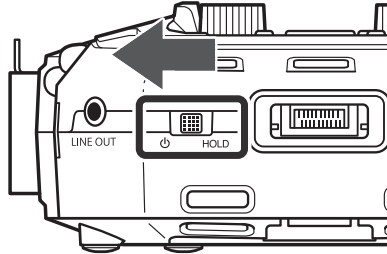

1. Slide   toward .

Turning the power off

1. Keep sliding   toward  until the ZOOM logo appears.

NOTE

- If “No Card!” appears on the display, confirm that an SD card is inserted properly.
- If “Card Protected!” appears on the display, the SD card write-protection is enabled. Slide the lock switch on the SD card to disable write-protection.
- If “Invalid SD Card!” appears on the display, the card is not formatted correctly. Format the card or use a different card. (→ [“Formatting SD cards” on page 121](#))

Preventing misoperation (HOLD function)

In order to prevent misoperation, the HOLD function can be used to disable operation of the **H8** buttons and touchscreen.

1. Slide   to [HOLD].

■ Deactivating the hold function

Slide   back to the middle.

Setting the display language (first time starting up)

The first time you turn the power on after purchase, set the touchscreen display language when the LANGUAGE Screen opens.

1. Tap the language you want to set.

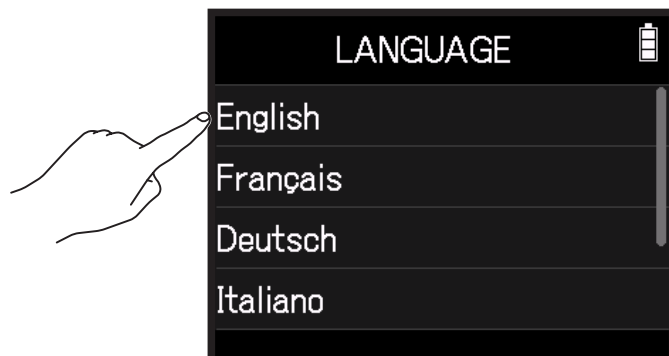

HINT

The display language can be changed later using Home Screen > Language. (→ [“Setting the language shown” on page 144](#))

Setting the date and time (first time starting up)

When the Set Date/Time Screen opens after the LANGUAGE Screen, set the date and time.

1. Swipe the date and time items to set them.

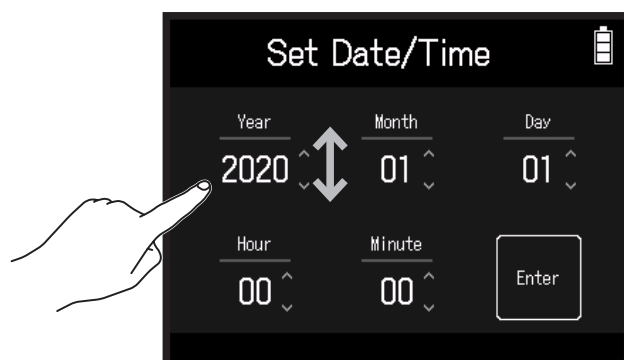

2. Tap **Enter**.

HINT

The date and time setting can be changed later using Home Screen > SYSTEM > Date/Time > Set Date/Time. (→ [“Setting the date and time” on page 131](#))

Connecting

Connection examples

Video recording (using the FIELD app to record audio)

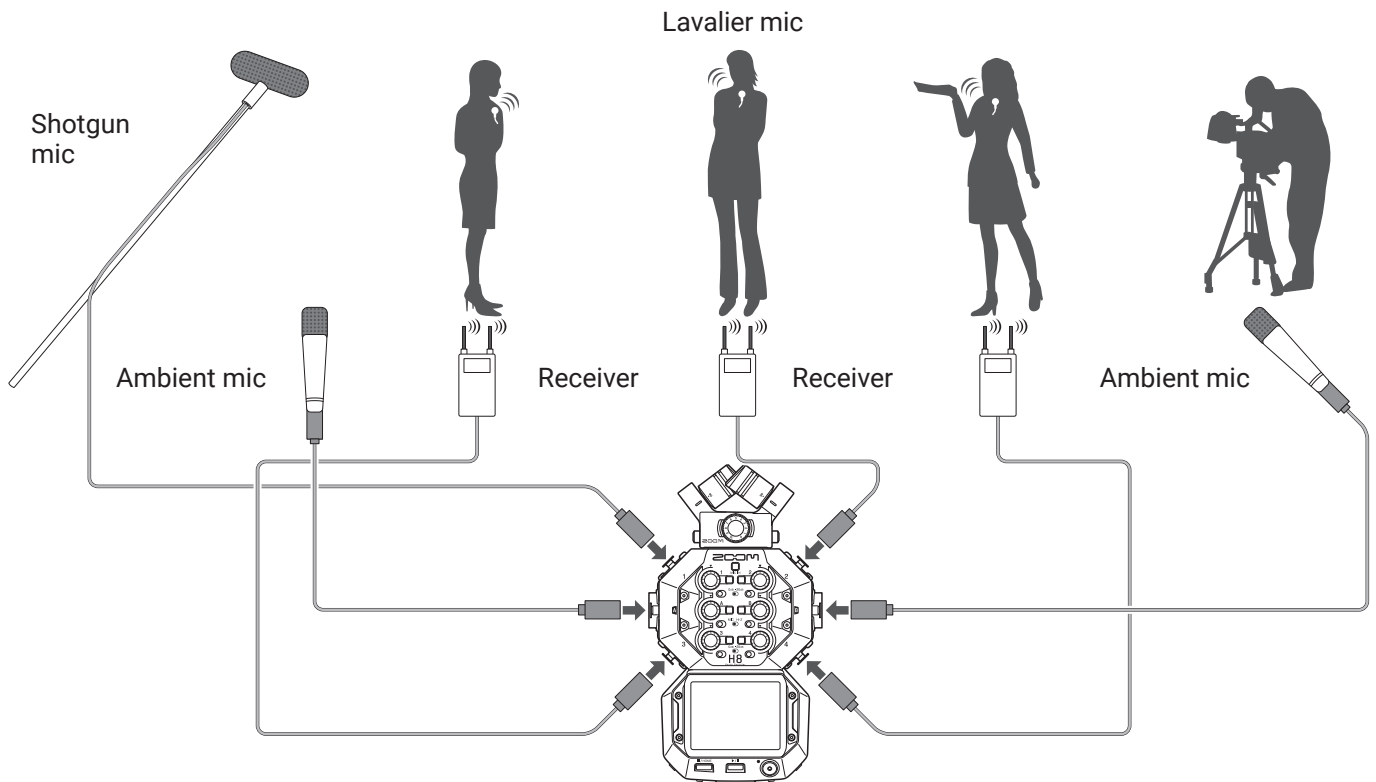

Band recording in a studio (using the MUSIC app to record audio)

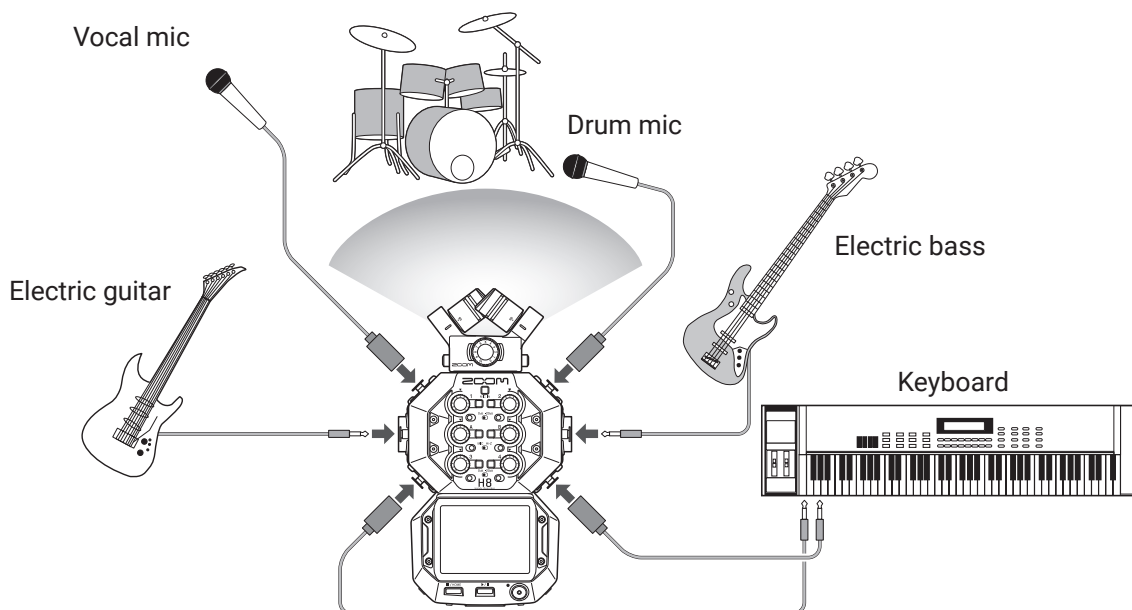

Podcasting (using the PODCAST app to record audio)

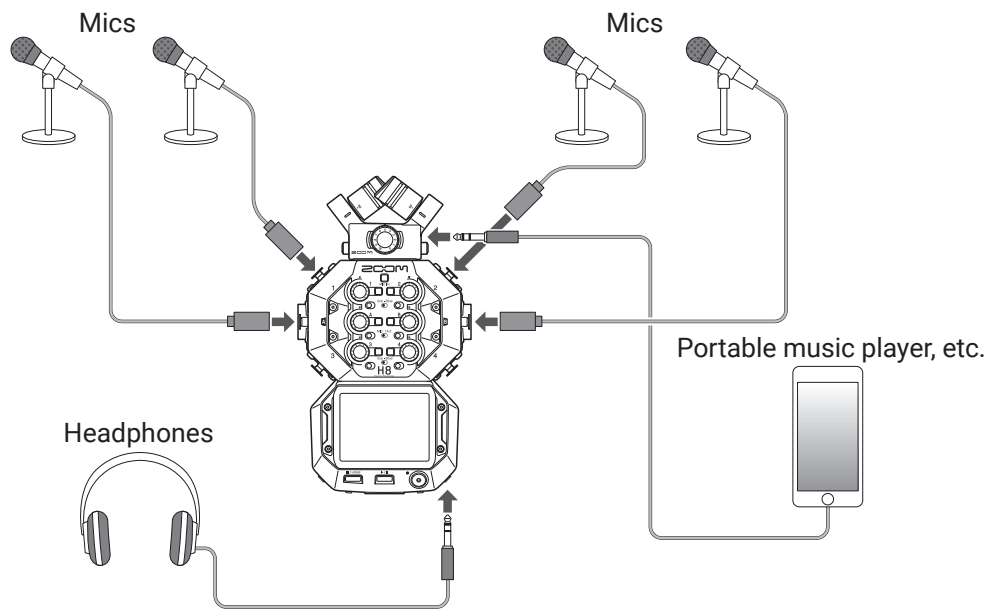

Connecting/disconnecting the mic capsule

Connecting the mic capsule

1. Remove the protective caps from the **H8** and the mic capsule.

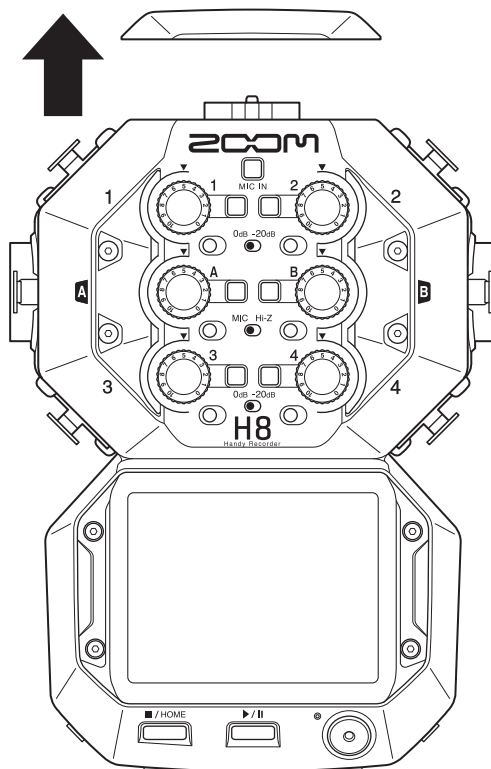

2. While pressing the buttons on the sides of the mic, connect it to the main unit, inserting it completely.

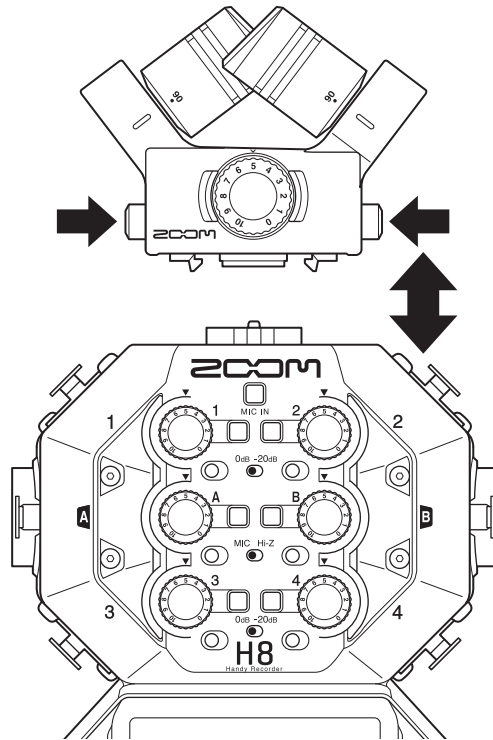

Disconnecting the mic capsule

1. While pressing the buttons on the sides of the mic, pull it out of the main unit.

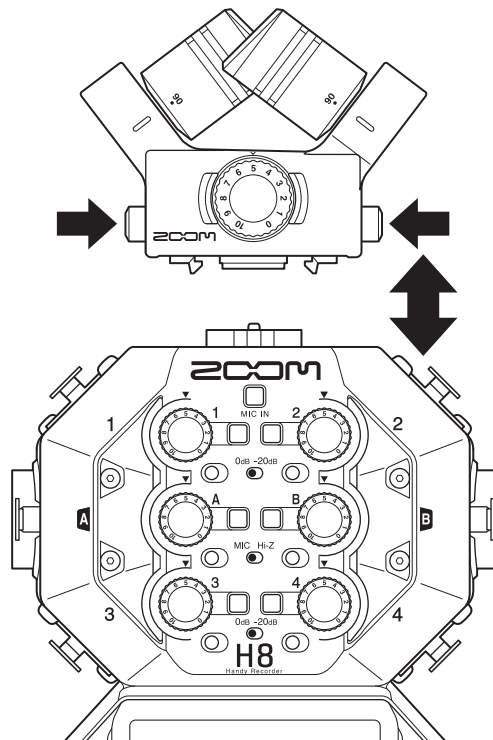

NOTE

- Do not use too much force when disconnecting. Doing so could damage the mic or the main unit.
- Recording will stop if a mic capsule is removed during recording.
- Attach the protective caps when the mic capsule will not be connected for a long time.

Connecting mics, instruments, mixers and other equipment

The **H8** can record up to 12 tracks at once. These include up to 4 tracks of input from a mic capsule, Inputs 1–4, A and B, and a stereo mix of these with L/R tracks (2 tracks).

Mics can be connected to Inputs 1–4 and instruments can be connected to Inputs A and B, for example, and recorded to corresponding input tracks 1–4, A and B.

Connecting mics

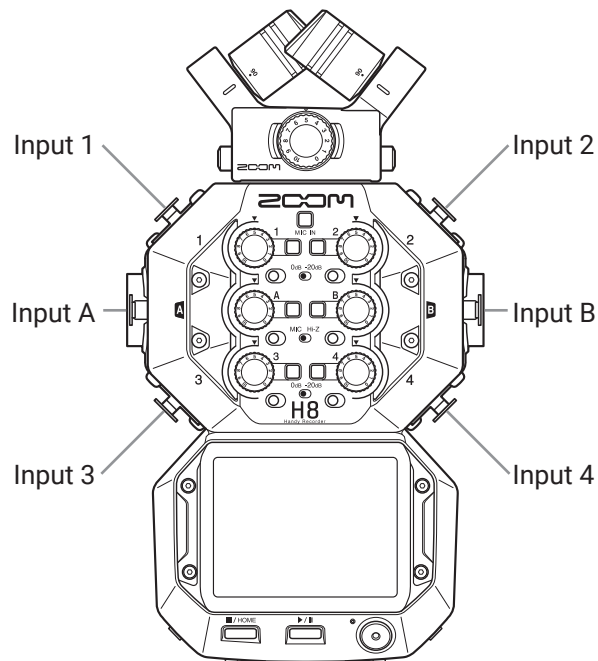

Connect dynamic and condenser mics with XLR plugs to Inputs 1–4, A and B. Phantom power (+24 V/+48 V) can be supplied to condenser mics. (→ [page 30](#))

Connecting instruments

When directly connecting guitars and bass guitars, connect their mono plugs to Input A or B. When connecting keyboards and other instruments with stereo outputs connect them to both input A and B.

When connecting a guitar or other device with high output impedance, set the corresponding Hi-Z switch (⊖) to **[Hi-Z]**.

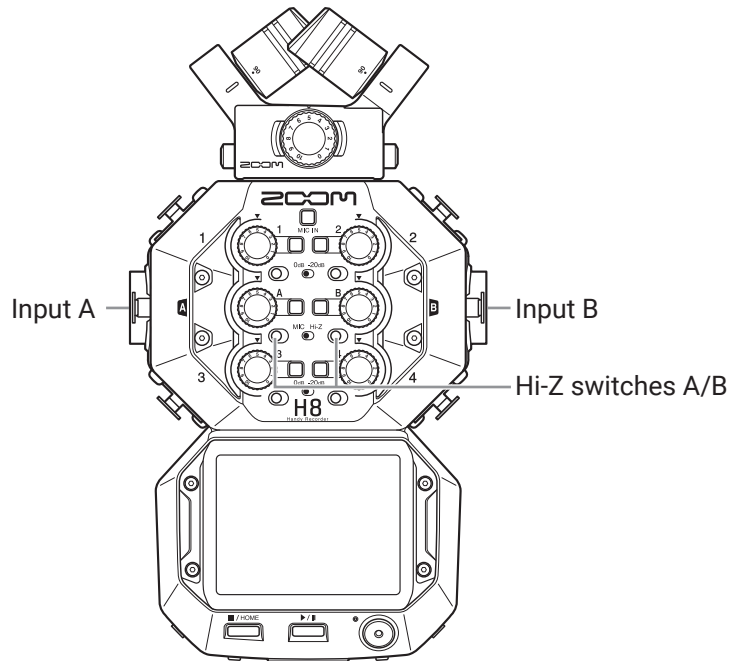

Connecting mixers and similar devices

Connect XLR cables from keyboards and mixers directly to Inputs 1–4.

For mixers and other devices with a rated output level of +4 dB, set the corresponding PAD switches (⊖) to **[-20dB]**.

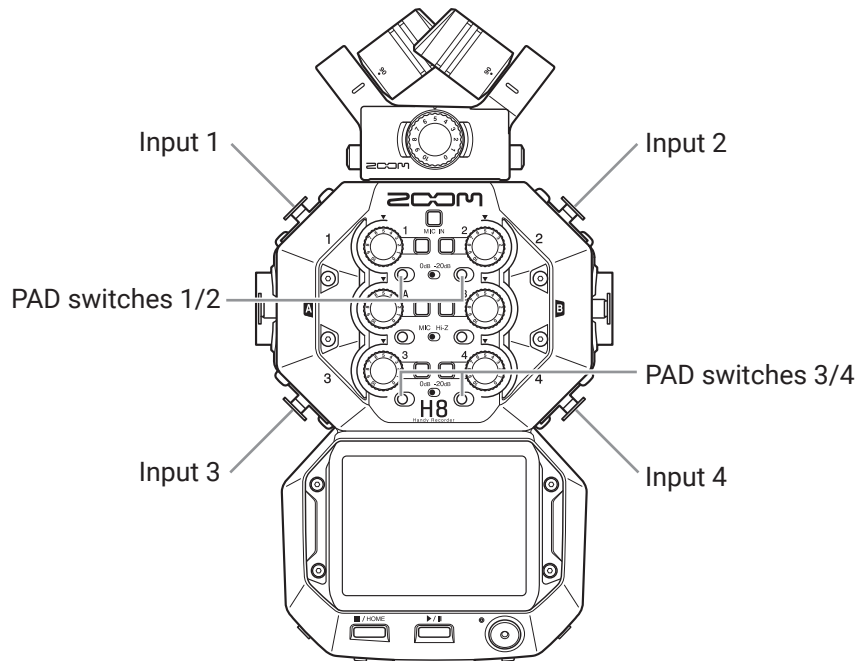

HINT

When connecting an ordinary mic, set the PAD switch to **[0dB]**.

Making input and output settings

Making settings for input tracks

Enabling tracks for recording

Select which tracks to record from MIC IN, 1–4 and A/B.

The MIC IN, 1–4 and A/B tracks correspond to the MIC IN, 1–4 and A/B inputs.

1. Launch a recording app.
2. Press the buttons for the tracks that you want to record.
The indicators for the selected track buttons will light red.

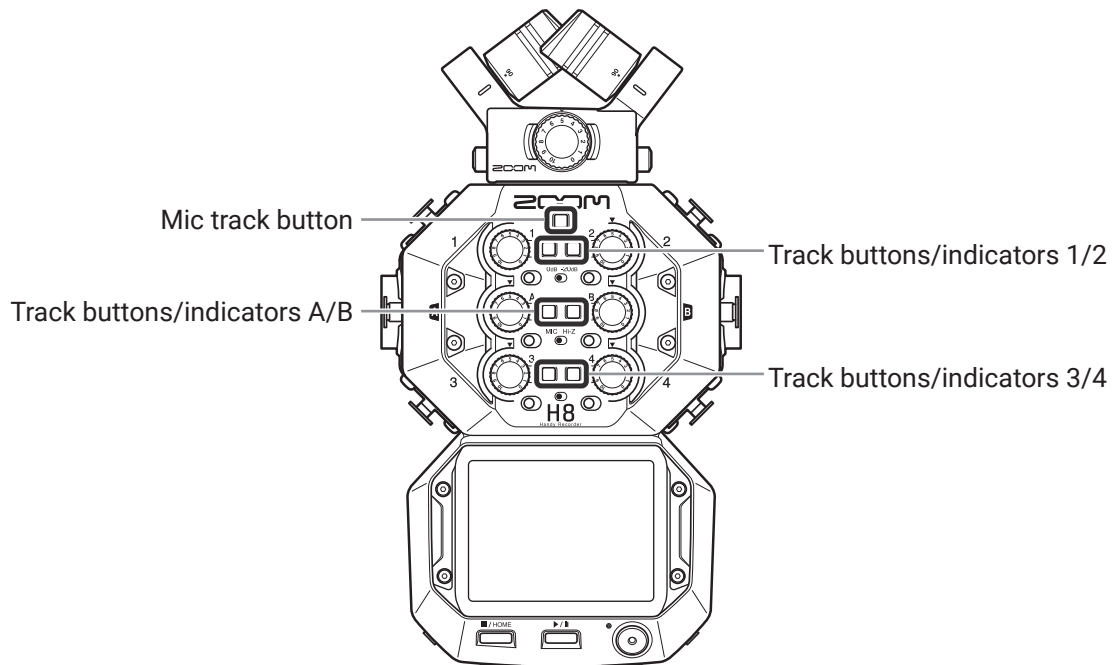

HINT

While pressing a track button, pressing the adjacent button (1 and 2, 3 and 4, or A and B) will stereo link those tracks, making a stereo track and creating stereo files on the SD card. Do the same thing to end a stereo link.

Setting recording (input) levels

Input levels can be adjusted for signals to be recorded.

1. Turn the input volume knob (🌀) for the selected track to adjust its input level.
Adjust so that the peak level stays around -12 dB.

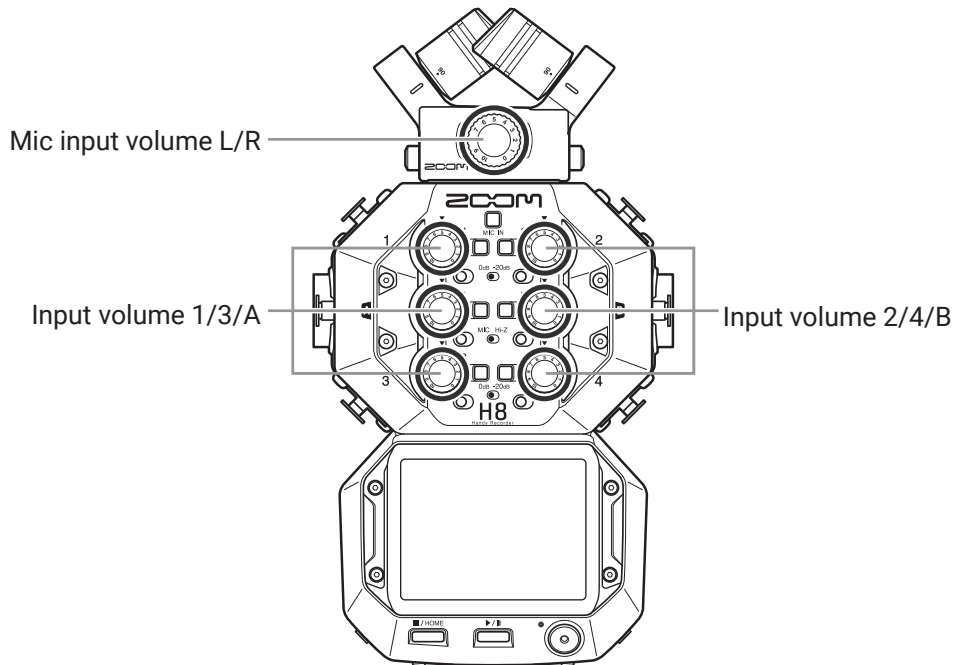

HINT



- If the sound distorts even after lowering the input level, try changing mic positions and adjusting the output levels of connected devices.
 - Plug-in power can be provided to the MIC/LINE IN input jack on the mic capsule.
(→ ["Using plug-in power" on page 28](#))
 - The Lo Cut function can be used when adjusting levels. (→ [page 33](#))
 - The Comp/Limiter/Gate function can be used when adjusting levels. (→ [page 34](#))
-

Backup recording (FIELD and PODCAST apps only)

When using a mic capsule with up to two channels on the MIC IN, a backup recording file can be recorded 12 dB lower than the set input level. This can be used to replace the regular recording file if its recording level was too high, causing distortion, for example.

1. Open the Track Setting Screen in the app.

Tap in the following order:

- FIELD app screen >  > select track
- PODCAST app screen >  > select track

2. Tap Backup Rec, and set to On.

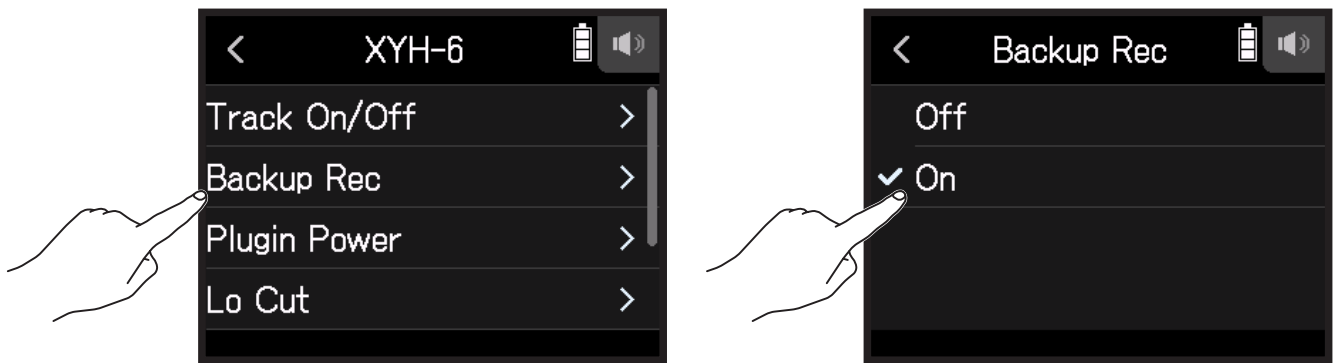

NOTE

- During backup recording, the Lo Cut and Comp/Limiter/Gate settings are not applied.
- To play a backup recording file, assign a file with “_BU” added to its name to a track. Then select and play it. (→ [“Changing files assigned to tracks” on page 74](#))

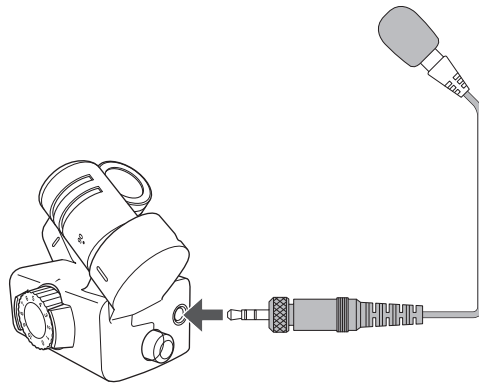

Using plug-in power

Make the following setting when a mic that is compatible with plug-in power is connected to the mic capsule MIC/LINE IN input jack.



1. Open the Track Setting Screen in the app.

Tap in the following order:

- FIELD app screen >  > select track
- MUSIC app screen > select track > 
- PODCAST app screen >  > select track

2. Tap **Plugin Power** and set to **On**.

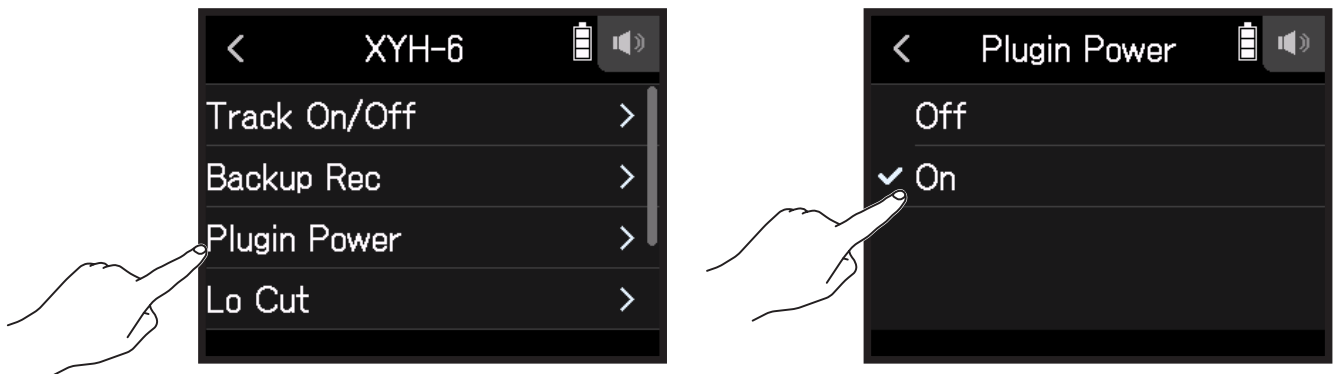

NOTE



This setting can be set only when a mic capsule that supports plug-in power is connected.

Adjusting the side mic level

You can adjust the side mic level (stereo width) before recording for tracks that use a mid-side mic.

1. Open the Track Setting Screen in the app.

Tap in the following order:

- FIELD app screen >  > select track
- MUSIC app screen > select track > 
- PODCAST app screen >  > select track

2. Tap MS Side Mic Level.

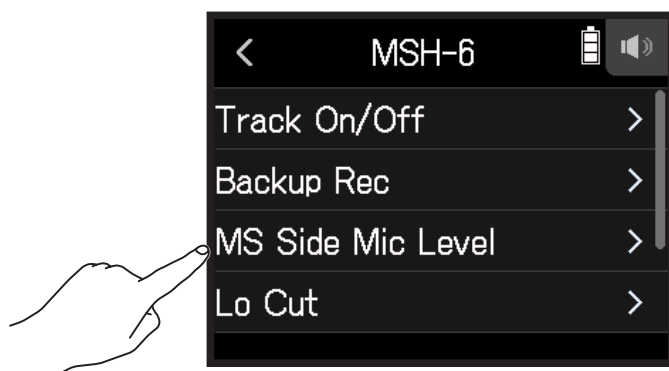

3. Slide up or down to adjust it.



HINT

- This can be set to Off, RAW or in a range from -24 to +6 dB.
- The more the side mic level is increased, the greater the stereo width becomes.
- The side mic level setting is also applied to backup recording when it is enabled.

NOTE

- When set to RAW, recording to the MIC IN tracks will occur without stereo encoding.
- Stereo encoding is conducted for L/R track recording and mixdown.
- The stereo width of audio in RAW format can be adjusted after recording by using ZOOM MS Decoder or other plug-in software.

Setting phantom power

H8 inputs 1–4, A and B support phantom power. They can supply power at +24 V or +48 V.

HINT



Phantom power is a function that supplies power to devices that require an external power supply, including some condenser mics. The standard power is +48V, but some devices can operate with lower voltages.

NOTE

Do not use this function with devices that are not compatible with phantom power. Doing so could damage the device.

1. Open the Track Setting Screen in the app.

Tap in the following order:

- FIELD app screen >  > select track
- MUSIC app screen > select track > 
- PODCAST app screen >  > select track

2. Tap Phantom.

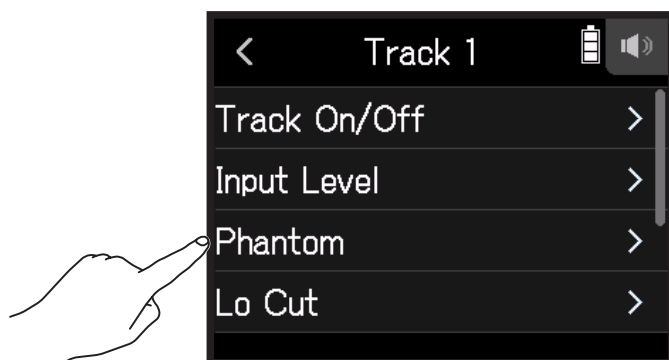

3. Tap On/Off.

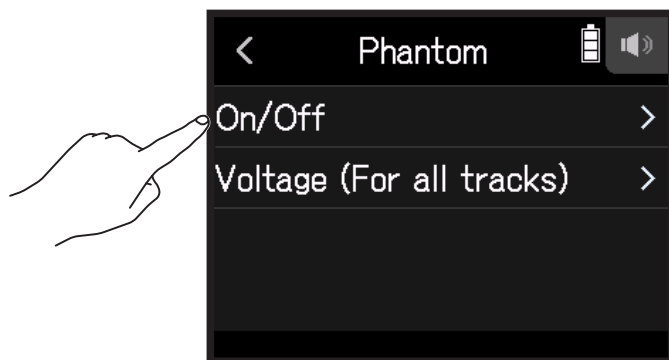

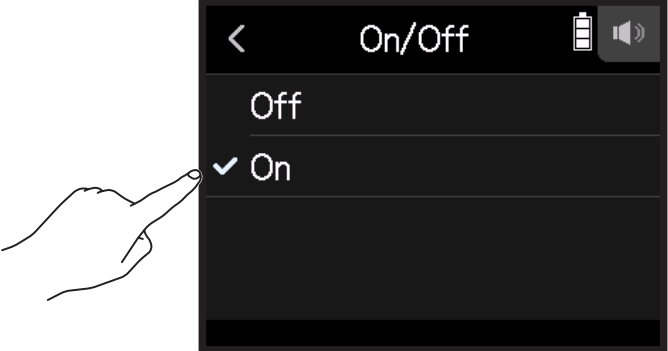

4. Tap On.



Setting phantom power voltage

1. Open the Track Setting Screen in the app.

Tap in the following order:

- FIELD app screen >  > select track
- MUSIC app screen > select track > 
- PODCAST app screen >  > select track

2. Tap Phantom.

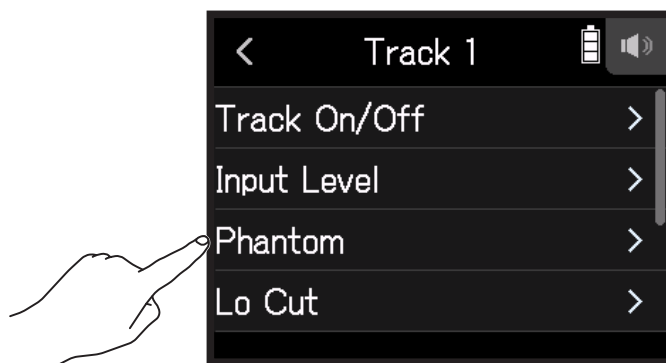

3. Tap Voltage (For all tracks).

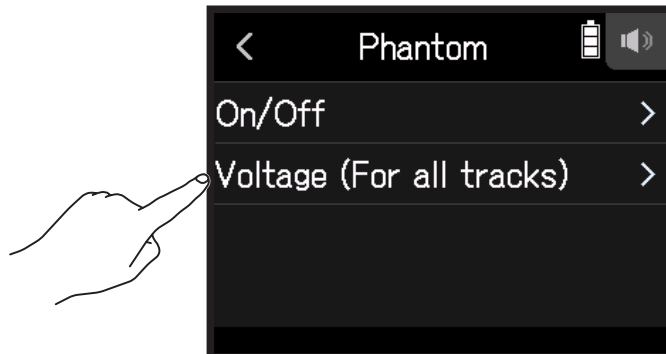

4. Tap +24V or +48V.

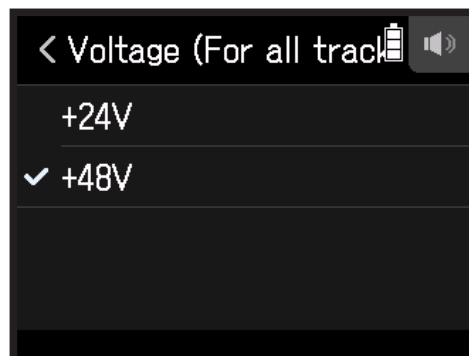

HINT



- When using mics and other equipment that can operate with voltages less than +48 V, selecting the lower voltage can reduce the **H8** power consumption.
- The phantom power setting is shared by all inputs.

Reducing noise (low-frequency cut)

The high pass filter can cut low frequencies to reduce the sound of wind, vocal pops and other noise.

1. Open the Track Setting Screen in the app.

Tap in the following order:

- FIELD app screen >  > select track
- MUSIC app screen > select track > 
- PODCAST app screen >  > select track

2. Tap Lo Cut.

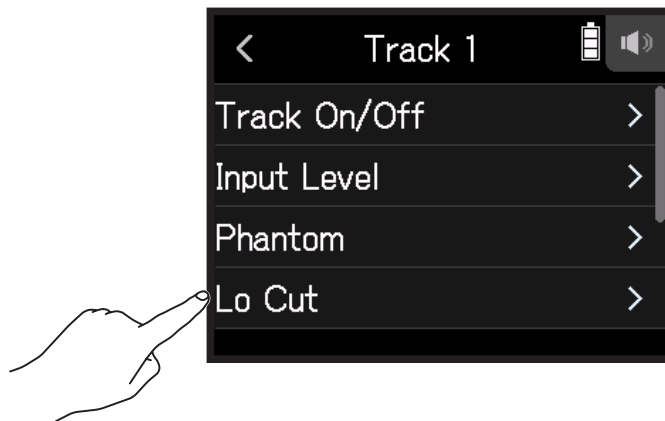

3. Slide up and down to set the desired cutoff frequency.

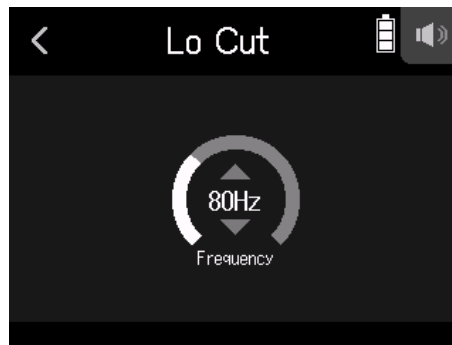

NOTE

This will not affect backup recording data.

HINT

This can be set to Off or 10–240 Hz.

Comp/Limiter/Gate

The volume can be adjusted suitably according to the input signal levels, making listening to them easier.

■ Compressor

This reduces level differences between loud and quiet sounds, making listening to them easier.

■ Limiter

This can prevent distortion by reducing input signals that have high levels.

■ Gate

This suppresses background noise when the input signal level is low.

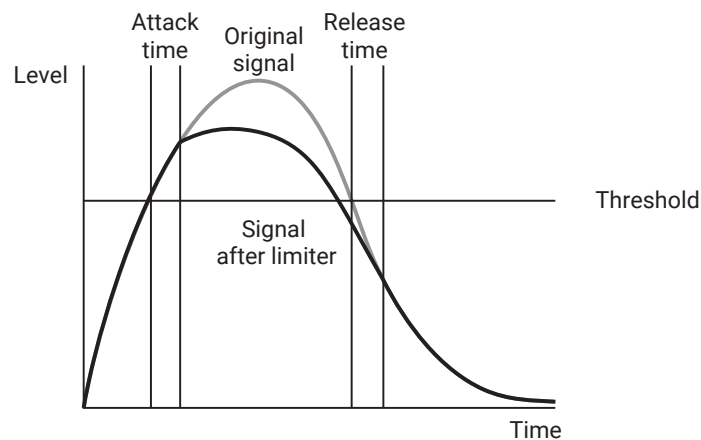



Parameter	Explanation
Threshold	This adjusts the threshold that triggers the effect.
Attack time	This adjusts the speed that the effect is triggered after the threshold level is exceeded.
Release time	This adjusts how quickly the effect stops after the signal goes below the threshold level.

■ Selecting the compressor, limiter or noise gate

1. Open the Track Setting Screen in the app.

Tap in the following order:

- FIELD app screen >  > select track
- MUSIC app screen > select track > 
- PODCAST app screen >  > select track

2. Tap **Comp/Limiter/Gate**.

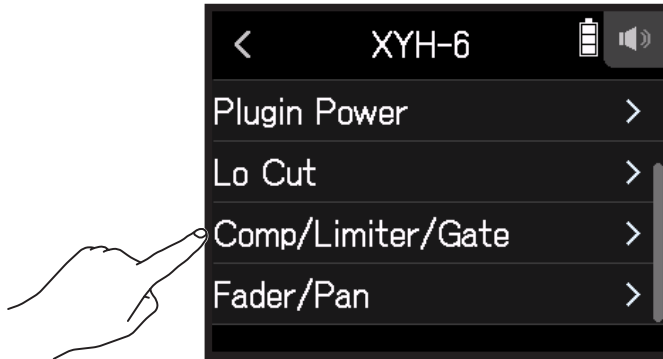

3. Tap **Type**.

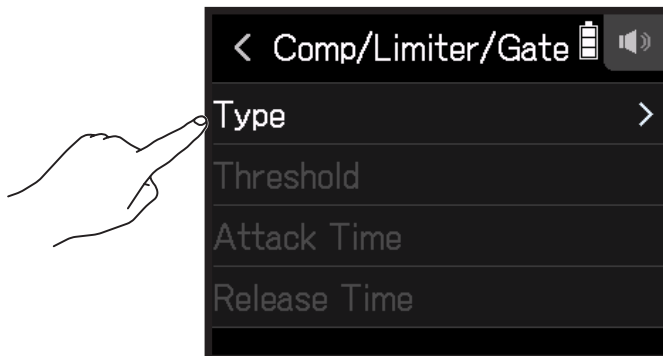

4. Tap **Comp**, **Limiter** or **Noise Gate**.

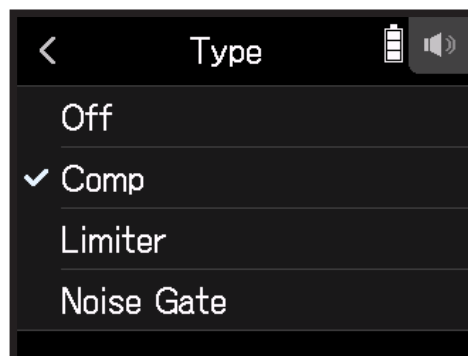



- **Comp**: This selects the compressor and sets the ratio to 4:1.
- **Limiter**: This selects the **Limiter** and sets the ratio to 20:1.
- **Noise Gate**: This selects the noise gate.
- **Off**: This disables the compressor, limiter and noise gate.

■ Setting the threshold

This sets the base level from which the limiter operates.

1. Open the Track Setting Screen in the app.

Tap in the following order:

- FIELD app screen >  > select track
- MUSIC app screen > select track > 
- PODCAST app screen >  > select track

2. Tap **Comp/Limiter/Gate**.

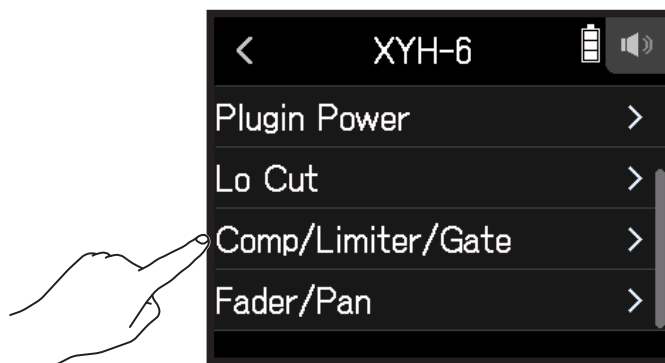

3. Tap **Threshold**.

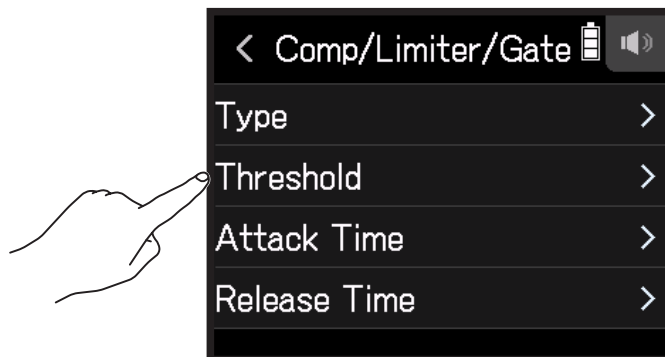

NOTE

Threshold cannot be set if Type is set to Off.

4. Slide up and down to adjust.

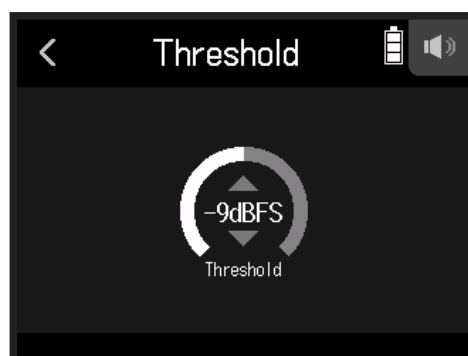

HINT



- This can be set from -16 to -2 dBFS for the compressor and limiter.
 - This can be set from -80 to -2 dBFS for the noise gate.
-

■ Setting the attack time

This sets the amount of time until compression starts after the input signal exceeds the threshold.

1. Open the Track Setting Screen in the app.

Tap in the following order:

- FIELD app screen >  > select track
- MUSIC app screen > select track > 
- PODCAST app screen >  > select track

2. Tap **Comp/Limiter/Gate**.

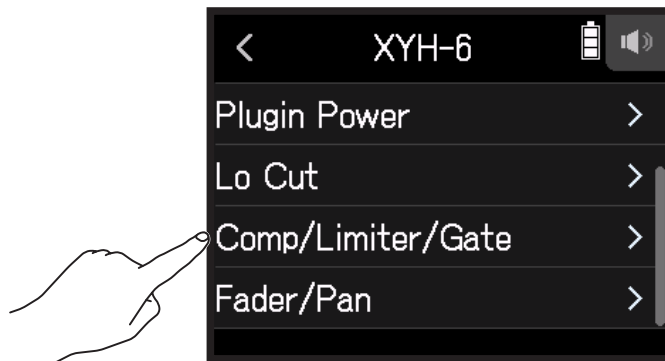

3. Tap **Attack Time**.

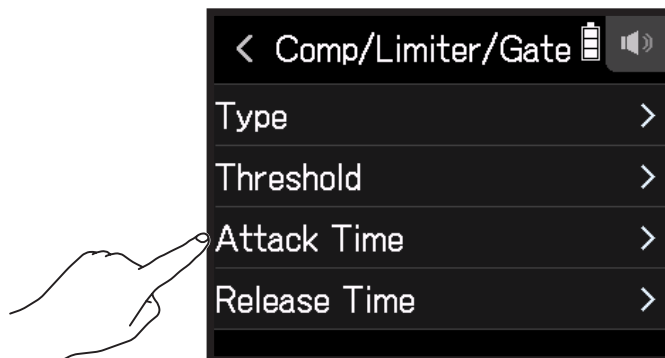
**NOTE**

Attack Time cannot be set if Type is set to Off.

- Slide  up and down to adjust the time.





HINT

This can be set from 1 to 4 ms.

■ Setting the release time

This sets the amount of time until compression stops after the input signal goes below the threshold.

- Open the Track Setting Screen in the app.
Tap in the following order:
 - FIELD app screen >  > select track
 - MUSIC app screen > select track > 
 - PODCAST app screen >  > select track

- Tap **Comp/Limiter/Gate**.

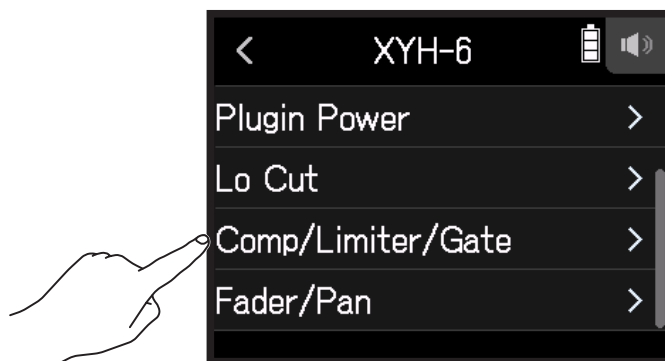

3. Tap Release Time.

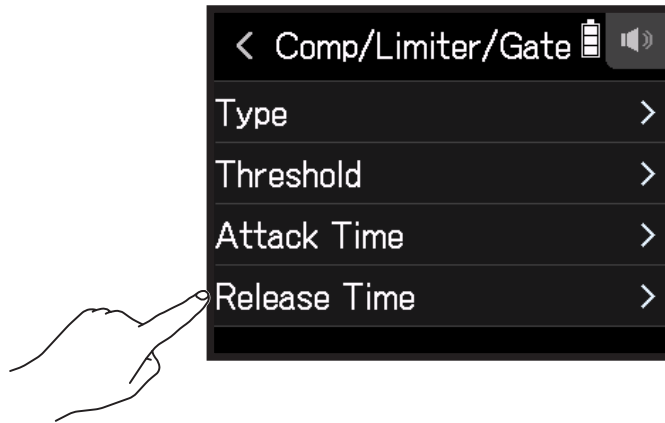

NOTE

Release Time cannot be set if Type is set to Off.

4. Slide up and down to adjust the time.



HINT



• Limiter operation is linked for tracks that have stereo link enabled. If the signal for either linked channel reaches the threshold, the limiter will operate on both tracks.

Adjusting input signal monitoring balance using fader and pan settings

The level and panning of each input signal when monitoring can be adjusted.

1. Open the Track Setting Screen in the app.

Tap in the following order:

- FIELD app screen >  > select track
- MUSIC app screen > select track > 
- PODCAST app screen >  > select track

2. Tap Fader/Pan.

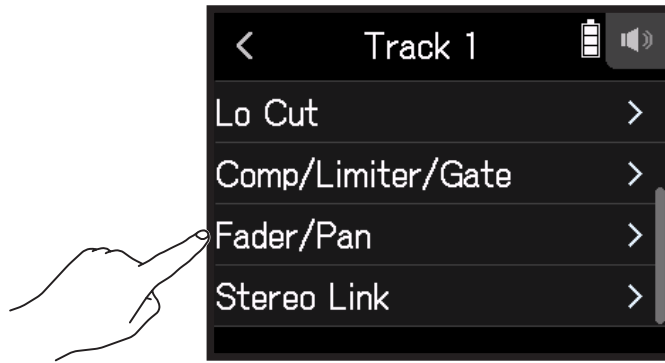

3. Select Fader or Pan.

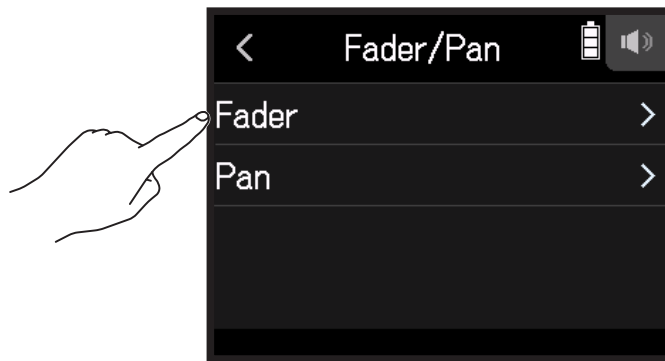

4. Slide  up and down to change their settings.

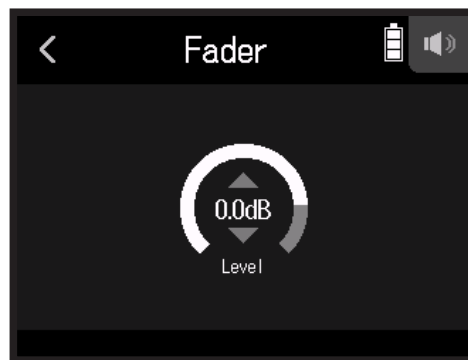



- Fader can be set to Mute or in a range of -48.0 dB – +10.0 dB (by 0.5 dB) to adjust the input signal level.
- Pan can be set to L100 – L1, Center, or R1 – R100 to adjust the left-right sound balance.

Enabling stereo linking

By enabling stereo tracks (stereo links), inputs can be handled as stereo sounds.

1. Open the Track Setting Screen in the app.

Tap in the following order:

- FIELD app screen >  > select track
- MUSIC app screen > select track > 
- PODCAST app screen >  > select track

2. Tap Stereo Link.

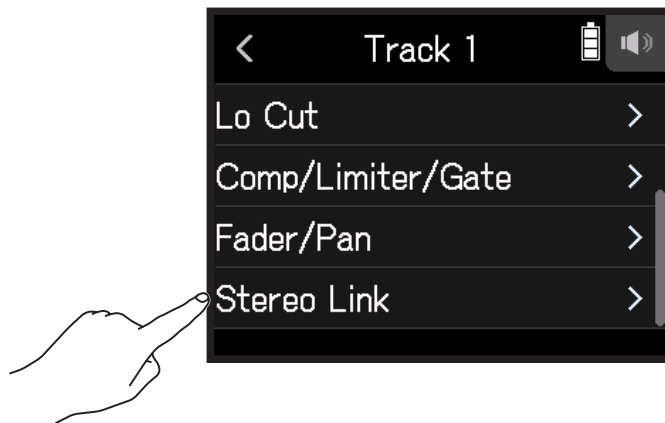

3. Tap On.

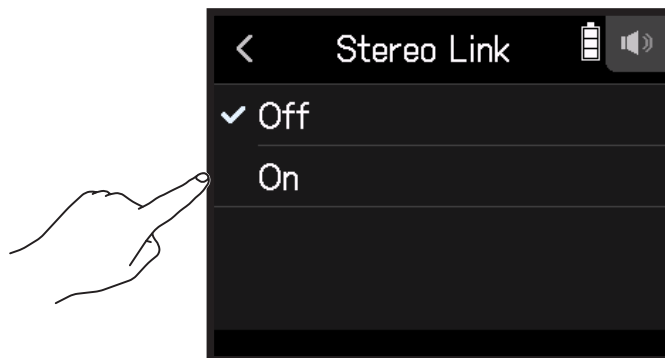

HINT



While pressing a track button, pressing the adjacent button (1 and 2, 3 and 4, or A and B) will stereo link those tracks, making a stereo track and creating stereo files on the SD card. Do the same thing to end a stereo link.

Setting the headphone output level

Use headphones, for example, to monitor input/playback sounds and adjust levels (volume).

HINT

- Monitoring with the speaker is possible during playback.
- If a cable is connected to the LINE OUT or PHONE OUT jack, sound will not be output from the **H8** speaker.

1. Connect headphones, for example, to the **H8** PHONE OUT jack.
2. Tap /  at the top right of the screen.

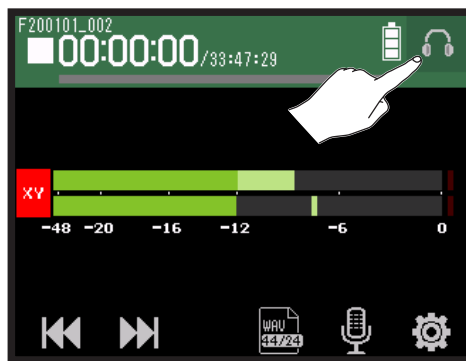



NOTE

A speaker icon will appear when headphones are not connected.

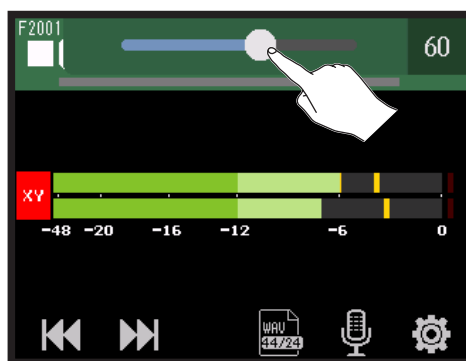
3. Slide  to adjust the volume.



4. Tap /  at the top right of the screen.

Adjusting connected equipment levels (playing test tones)

The line output level can be adjusted.

Test tones can be played in order to adjust the level for a digital SLR camera or other device.

1. Minimize the input volume of the other device.
2. Use an audio cable to connect the external mic jack of the other device with the **H8 LINE OUT** jack.
3. Tap  **LINE OUT LEVEL** on the Home Screen.

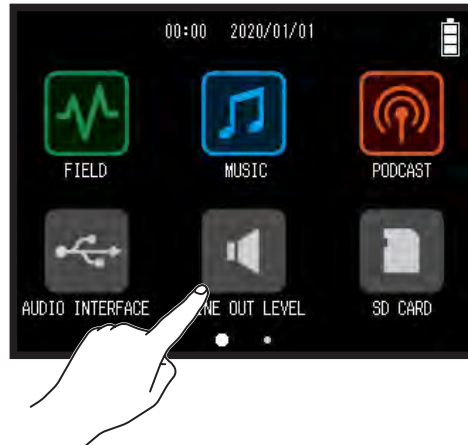

4. Tap  **Test Tone**.

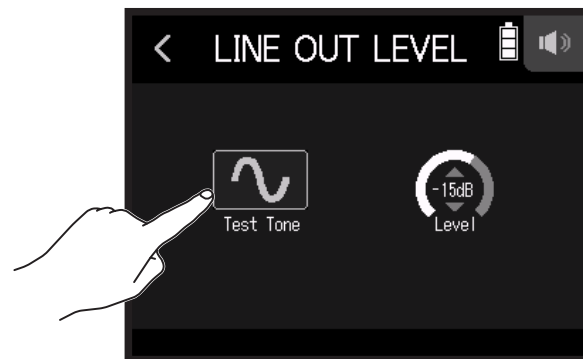

This starts output of the test tone.

5. Slide  up and down to adjust the output level.

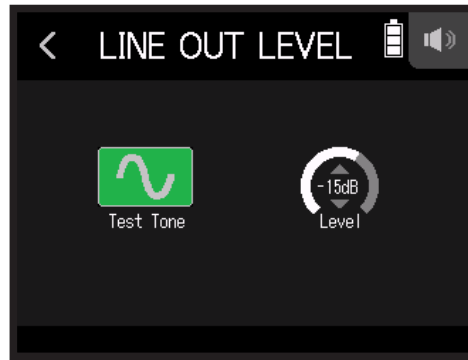

While checking the audio level meter of the other device, adjust the audio signal level so that it never exceeds -12 dB.

HINT

This can be set from -40 to 0 dB.

6. Make small adjustments to the input volume of the other device.

While checking the audio level meter of the connected device, make adjustments to the input gain of that device until the audio signal level is about -12 dB.

7. Tap  Test Tone.

This stops test tone output.

NOTE

- See the manual of the connected device for information about its operation.
- The test tone is output from both the **LINE OUT** and **PHONE OUT** jacks.
- Be careful with the volume if you are monitoring the sound with headphones, for example.

HINT

The test tone is a 1kHz sine wave at -12 dBFS.

Recording with the FIELD app

Display overview

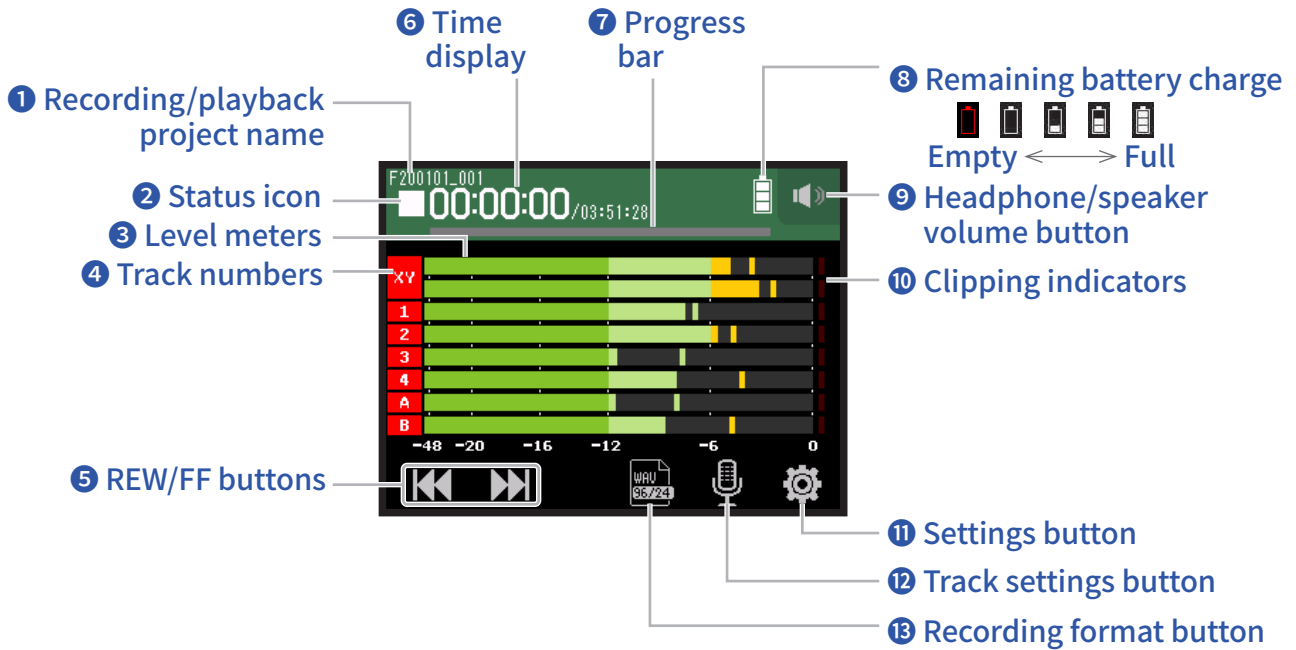

1 Recording/playback project name

2 Status icon

This shows the recording/playback status.

■ : Stopped ● : Recording || : Recording/playback paused ► : Playing

3 Level meters

4 Track numbers

Red: Input enabled

Green: Playback track enabled

Gray: Input disabled

Adjacent track numbers are connected to show input link settings.

5 REW/FF buttons

Use to select projects and to search backward and forward.

6 Time display

00:00:00/00:00:00

When recording

Left: Current elapsed recording time

Right: Remaining available recording time

When playing

Left: Current elapsed playback time

Right: Remaining playback time

7 Progress bar

This shows the current playback location.

Mark positions are shown above the progress bar.

Slide  to change the playback position.

8 Remaining battery charge

This shows the remaining battery charge. When the remaining battery charge becomes low, replace the batteries (→ [“Using batteries” on page 17](#)) or connect an AC adapter (→ [“Using an AC adapter” on page 17](#)).

9 Headphone/speaker volume button

Touch this to show the headphone/speaker volume slider. (→ [page 42](#))

10 Clipping indicators

If a clipping indicator lights, adjust the input level (→ [“Setting recording \(input\) levels” on page 26](#)) or set the limiter (→ [“Comp/Limiter/Gate” on page 34](#)).

11 Settings button

Press to access a list of projects on the SD card (→ [page 107](#)) and to make automatic recording settings (→ [page 50](#)).

12 Track settings button

Press to make track settings, including Lo Cut and Phantom functions. (→ [page 27](#))

13 Recording format button

Use to set the recording format. (→ [page 47](#))

Recording



Recording process

Recording follows the process shown below.

Prepare to record

- Insert an SD card
- Use batteries or an AC adapter
- Connect the mic capsule
- Connect mics, instruments, mixers and other equipment
- Turn the power on
- Set the recording format
- Make input and output settings

Record

- Press  to start recording and press  to stop
- Marks can also be added
- Press  to pause

Play and check

- Press  to start playback and  to stop
- Cue to mark positions and to make project mixer settings, for example

Setting the recording format

Considering audio quality and file size, select the format.

1. Tap .

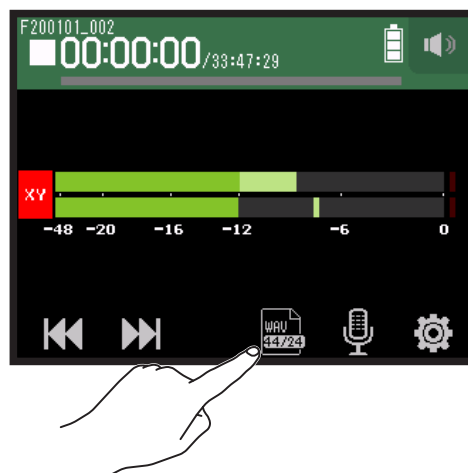

2. Tap the recording format to set it.

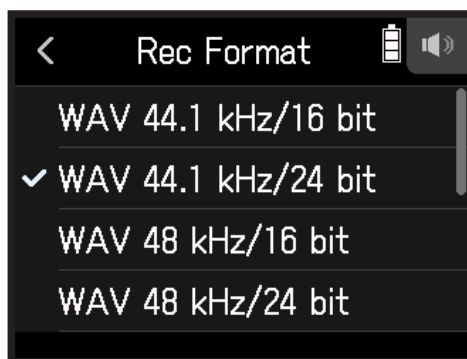

The following formats can be set.

They are shown in order of audio quality (from low to high) and file size (from small to large).

Setting	Explanation
MP3 128 kbps	The sampling frequency is 44.1 kHz. The higher the bit rate is, the better the audio quality will be.
MP3 192 kbps	
MP3 320 kbps	
WAV 44.1 kHz/16 bit	The higher the sampling frequency (kHz) and bit rate (bit) are, the better the audio quality will be.
WAV 44.1 kHz/24 bit	
WAV 48 kHz/16 bit	
WAV 48 kHz/24 bit	
WAV 96 kHz/16 bit	
WAV 96 kHz/24 bit	

Recording

1. Press  on the FIELD app screen.

This starts recording.

2. Press  to pause.

NOTE

- When recording is paused, a mark is added at that point. Press  again to resume recording.
- A maximum of 99 marks can be added in a project.

HINT

Marks can be added without pausing. (→ [“Setting how marks are added when recording/playing” on page 135](#))

3. Press  to stop.

NOTE

If the file size exceeds 2 GB during recording, recording will continue in a new project with a number that is one higher. No gap in sound will occur between the two projects when this happens.

HINT





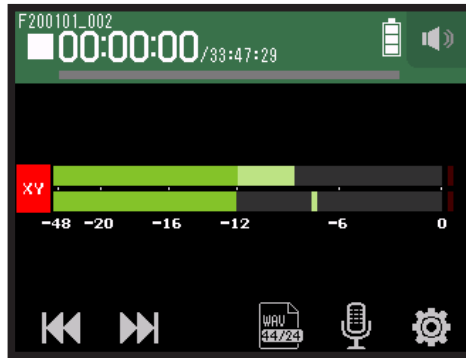

Files are automatically saved at regular intervals during recording. If the power is interrupted or another problem occurs during recording, an affected file can be restored to normal by playing the automatically saved file with the **H8**.

Playing recordings





1. Press .

Playback operations

Operation	Touchscreen/button operation
Select playback project/move to mark	Tap  
Search forward/backward	Press and hold   Slide  left/right
Pause/resume playback	Press 
Stop	Press 

HINT

- Slide left/right  to change the playback position.
- During playback, press track buttons to switch between playing back (lit green) and muted (unlit).
- If the selected project is not valid, an "Invalid Project!" message will appear.
- If no playable project exists, a "No Project!" message will appear.
- During playback, press  to add marks that can be used for cueing. (→ ["Setting how marks are added when recording/playing" on page 135](#))

Recording automatically

Recording can be started and stopped automatically in response to the input level.

1. Tap .

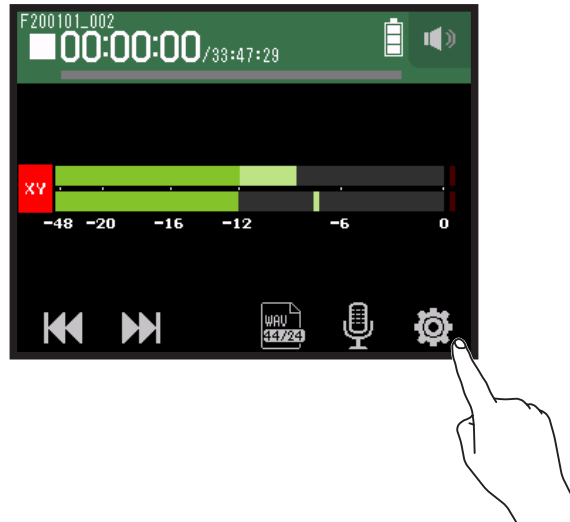

2. Tap **Auto Rec**.

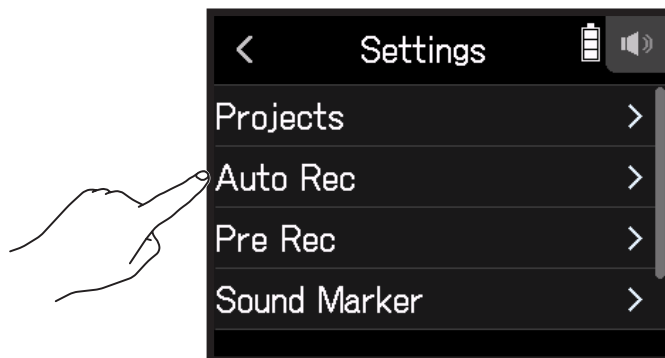

3. Tap **On/Off**.

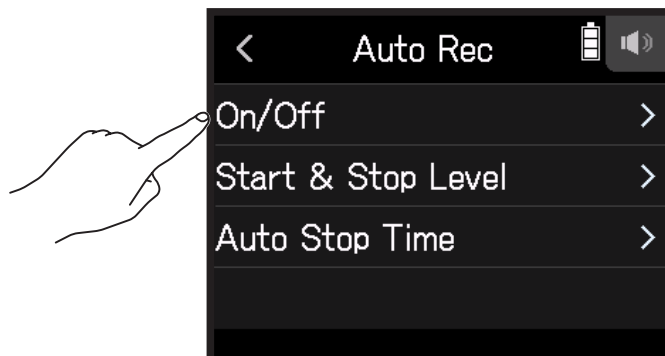



4. Tap **Start** or **Start & Stop**.



5. Return to the top screen of the FIELD app, and press . This will start automatic recording standby.

HINT

- Pressing  again will start recording immediately.
- Press  to end recording standby or stop recording.

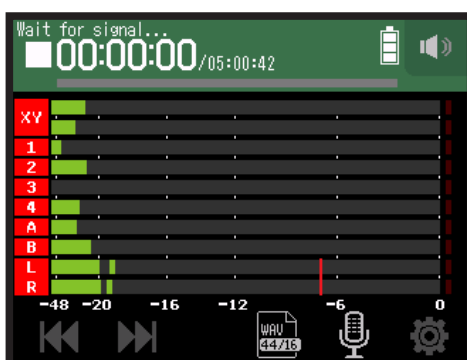

Setting automatic recording start/stop levels

1. Tap .

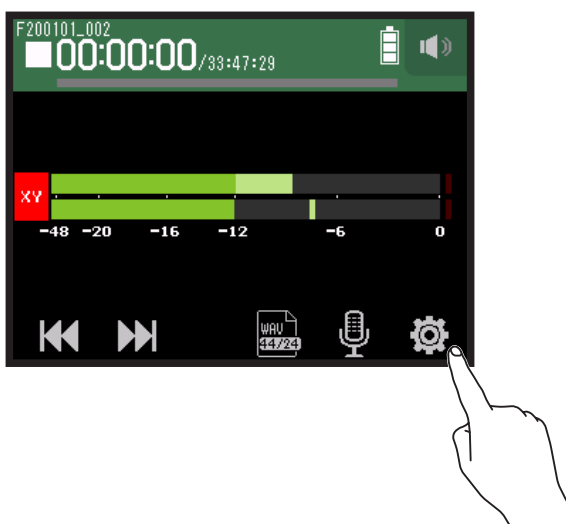

2. Tap **Auto Rec**.

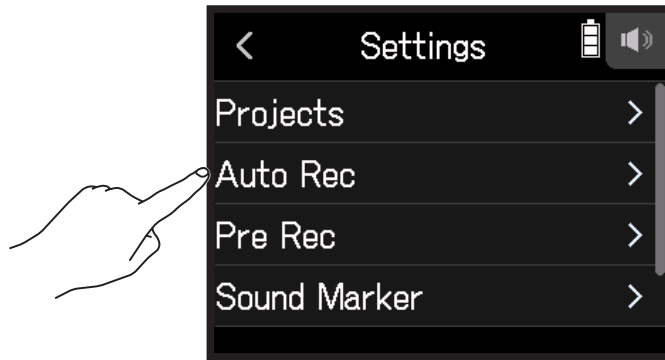

3. Tap **Start & Stop Level**.

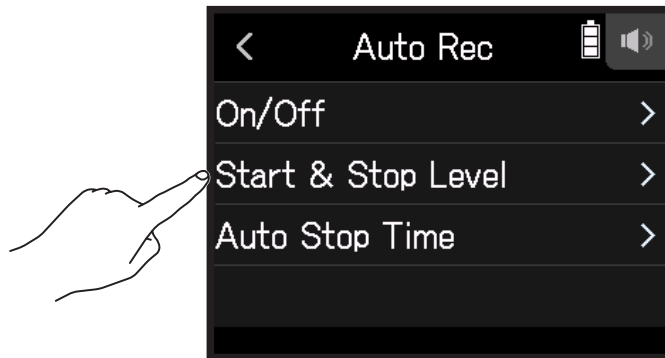

4. Slide **Start Level** and **Stop Level** left and right to set their levels.

- The red line shows the recording start level, and the blue line shows the recording stop level.



Recording will start automatically when the input level exceeds the set start level.

Recording will stop automatically when the input level becomes lower than the set stop level.

HINT

This can be set from -48 to 0 dBFS.

Setting the automatic recording stop time

This sets the time until recording stops automatically after the input level becomes lower than the set stop level.

1. Tap .

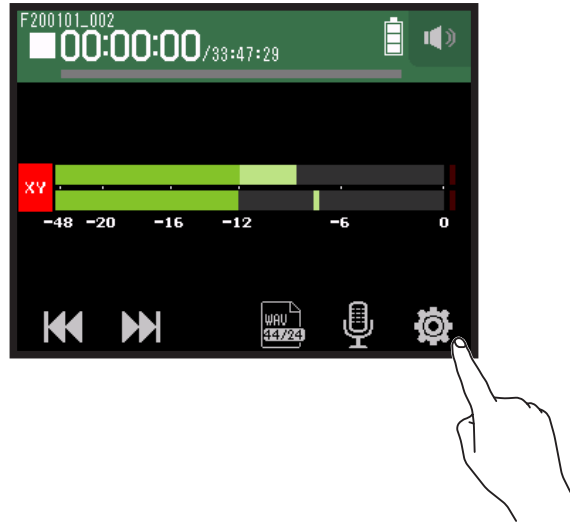

2. Tap **Auto Rec**.

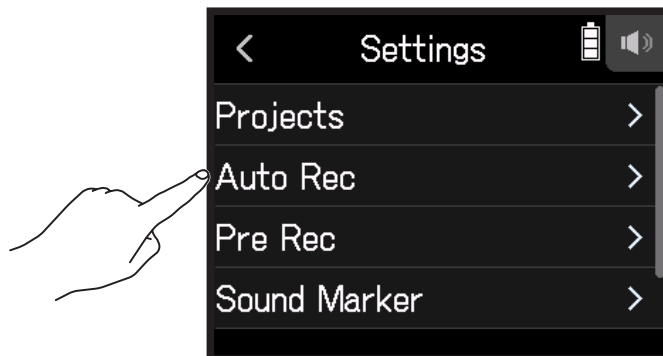

3. Tap **Auto Stop Time**.

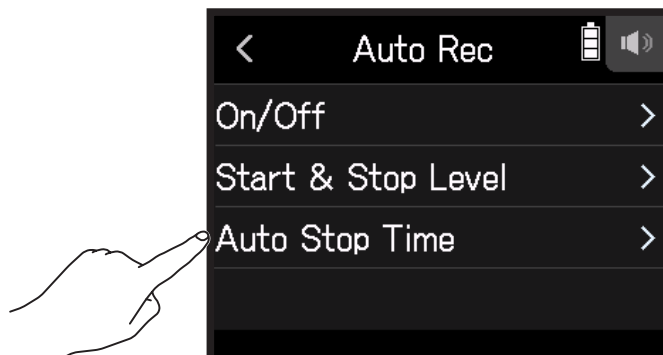



- Slide  up and down to set the level.

**HINT**

- This can be set from 0 to 5 seconds.
- After stopping recording automatically, automatic recording standby starts.

Capturing audio before recording starts (pre-recording)

The input signal is always buffered for a set amount of time, so it can be captured for up to 6 seconds before  is pushed (pre-recording). This is useful when  is pressed late, for example.

- Tap .

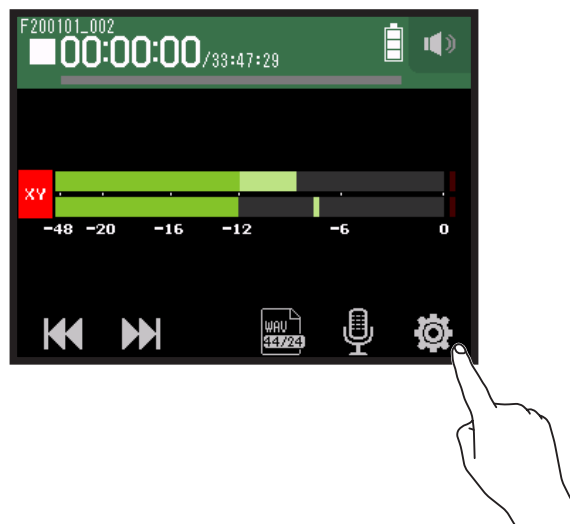

2. Tap Pre Rec.

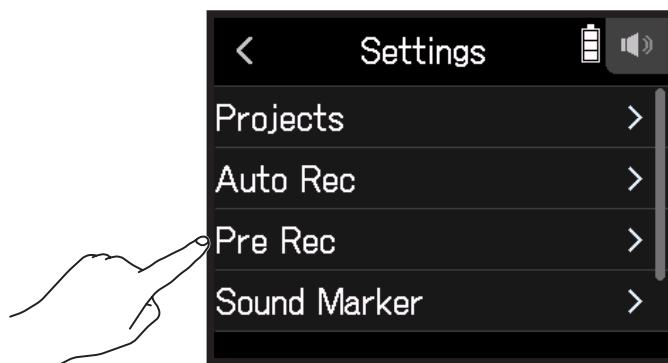

3. Tap On.

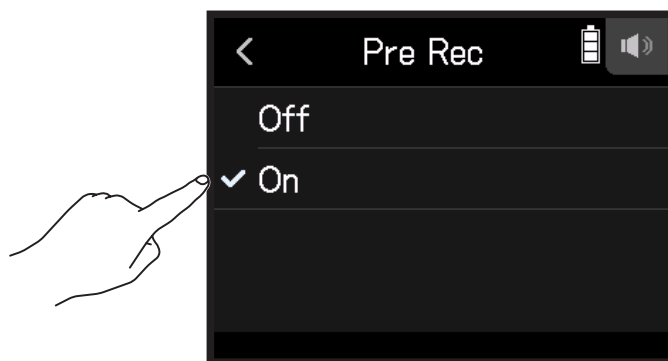

Recording format	Maximum pre-recording time
MP3 128 kbps	6 seconds
MP3 192 kbps	
MP3 320 kbps	
WAV 44.1 kHz/16 bit	
WAV 44.1 kHz/24 bit	
WAV 48 kHz/16 bit	
WAV 48 kHz/24 bit	3 seconds
WAV 96 kHz/16 bit	
WAV 96 kHz/24 bit	

Enabling the sound marker function

Half-second tone signals (sound markers) can be output from the output jacks (**PHONE OUT** and **LINE OUT**) when recording is started and stopped. Since sound markers are also written to recording files, when recording audio for video with the **H8**, sending its output signal to the camera input can make synchronizing audio and video easier.

1. Tap .

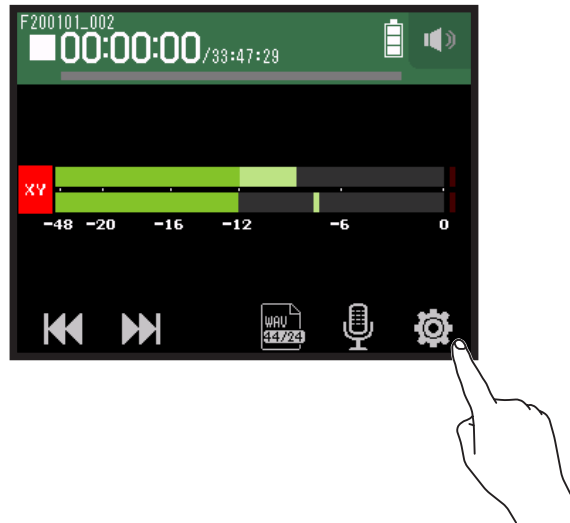

2. Tap **Sound Marker**.

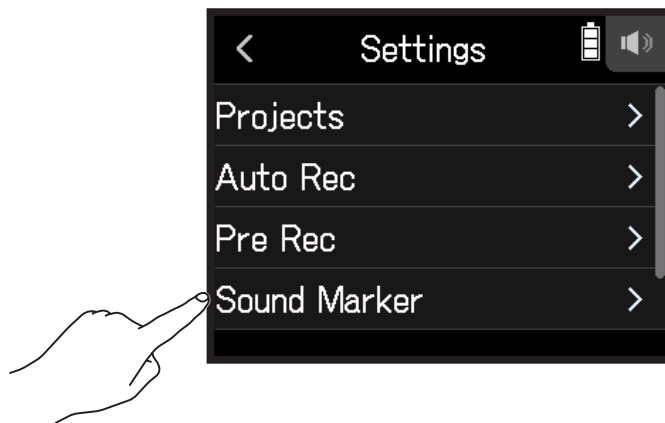

3. Tap **On**.

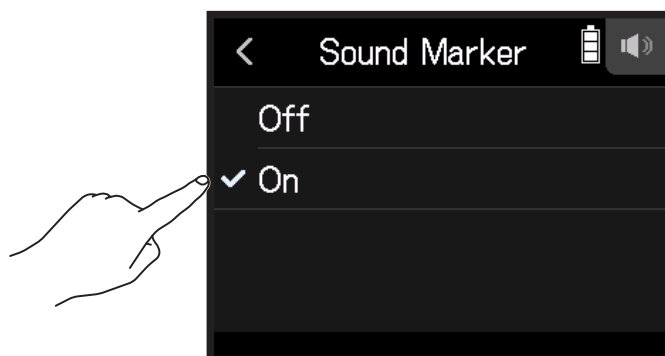

NOTE

Be careful with the volume if you are monitoring the input sound with headphones, for example.

Recording L/R tracks

During recording, a stereo file can be created based on the mix from the internal mixer.

1. Tap .

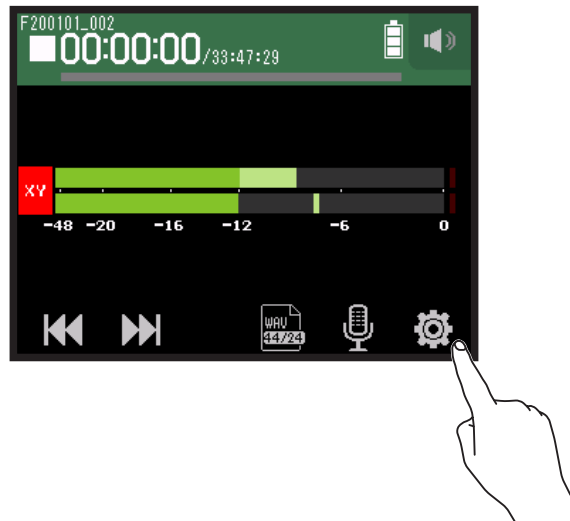

2. Tap **Track L/R On/Off**.

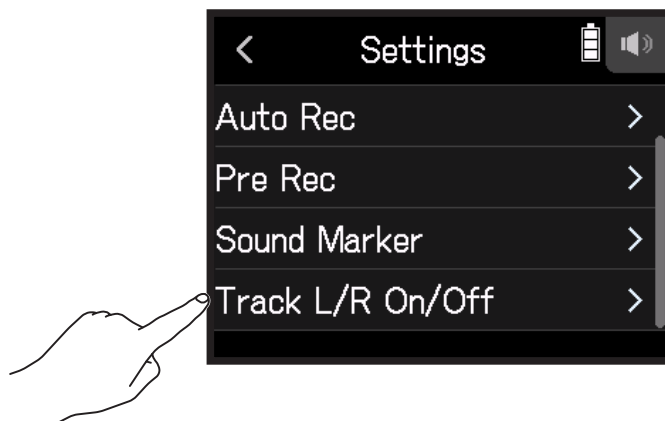

3. Set it to On.

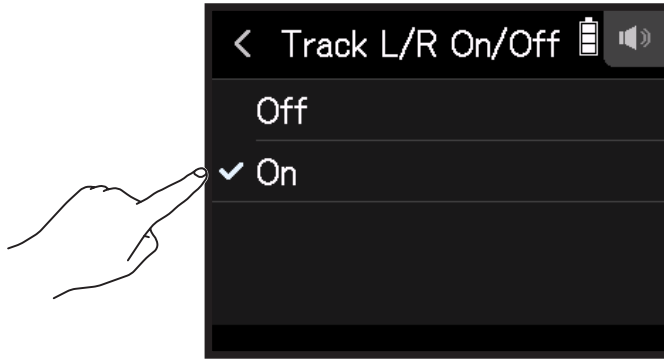

Recording with the MUSIC app

Display overview

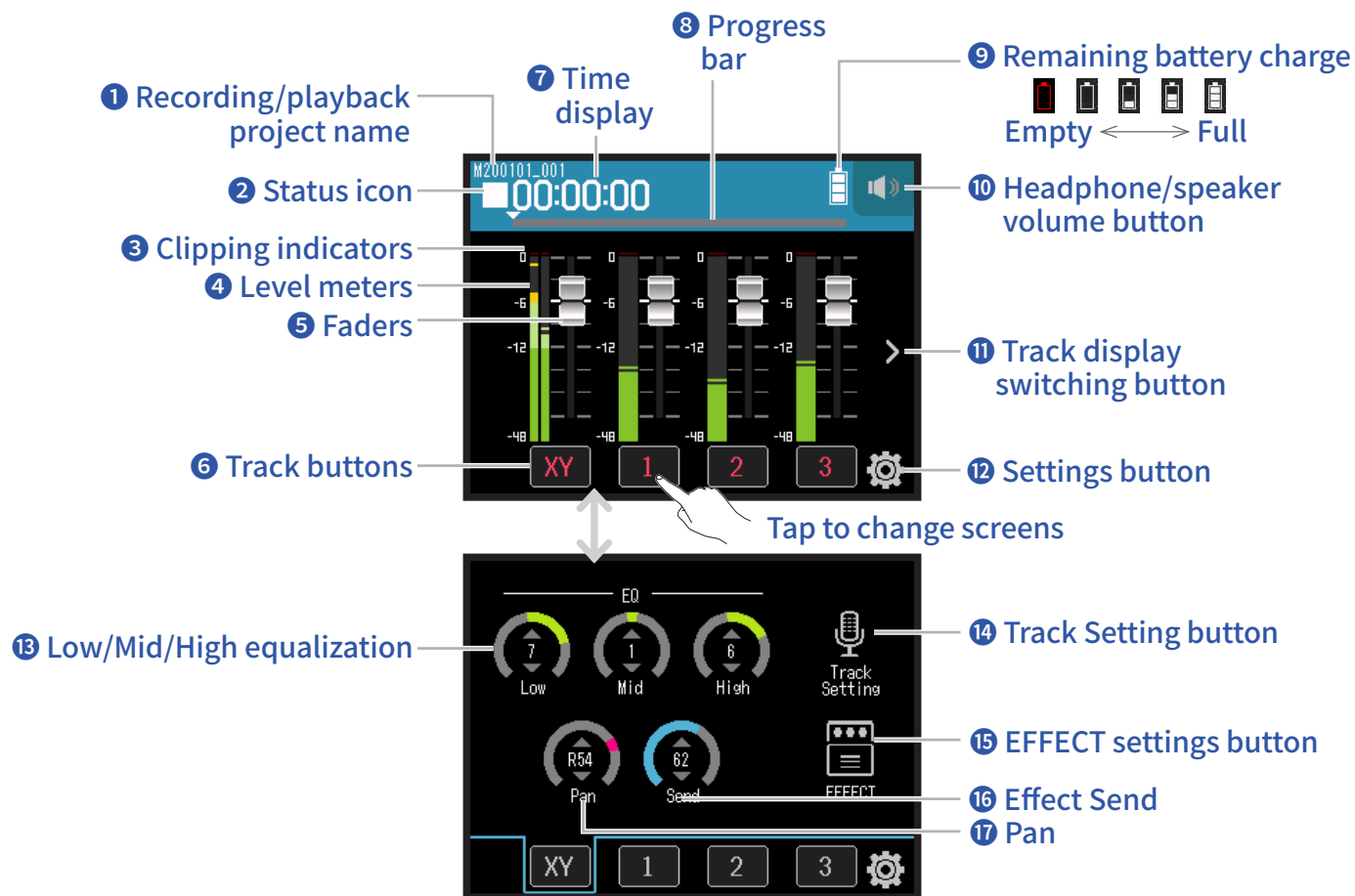

1 Recording/playback project name

2 Status icon

This shows the recording/playback status.

■ : Stopped ● : Recording || : Recording/playback paused ► : Playing

3 Clipping indicators

If a clipping indicator lights, adjust the input level (→ [“Setting recording \(input\) levels” on page 26](#)) or set the limiter (→ [“Comp/Limiter/Gate” on page 34](#)).

4 Level meters

5 Faders

6 Track buttons

Tap these to open track channel strip screens.

7 Time display

00:00:00/00:00:00

When recording

Left: Current elapsed recording time

Right: Remaining available recording time

When playing

Left: Current elapsed playback time

Right: Remaining playback time

8 Progress bar

This shows the current playback location.

Slide ▼ to change the playback position.

9 Remaining battery charge

This shows the remaining battery charge. When the remaining battery charge becomes low, replace the batteries (→ [“Using batteries” on page 17](#)) or connect an AC adapter (→ [“Using an AC adapter” on page 17](#)).

10 Headphone/speaker volume button

Touch this to show the headphone/speaker volume slider. (→ [page 42](#))

11 Track display switching button

This changes the tracks shown

12 Settings button

Press to access a list of projects on the SD card (→ [page 107](#)) and to create new projects (→ [page 61](#)).

13 Low/Mid/High equalization

These can be used to boost and cut the equalization of low, mid and high frequencies.

14 Track Setting button

Press to make track settings, including Lo Cut and Phantom functions. (→ [page 28](#))

15 EFFECT settings button

Insert effects can be used. (→ [“Using effects” on page 68](#))

16 Effect Send

Use this to adjust the level sent to the send effect.

17 Pan

Use this to adjust the left-right balance.

Creating new projects

The **H8** manages recording and playback data in units called projects.

1. Tap .

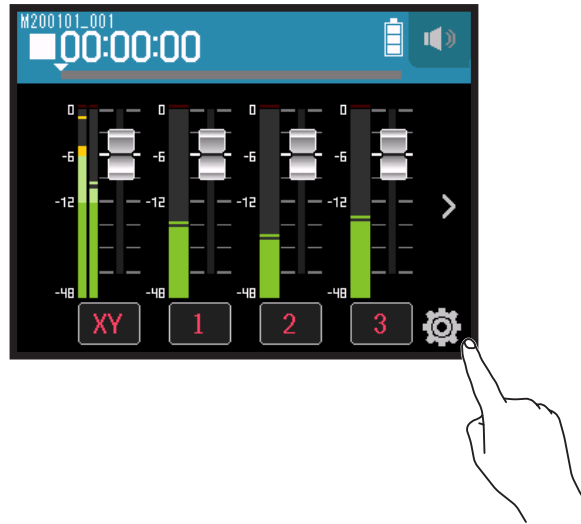

2. Tap **New Project**.

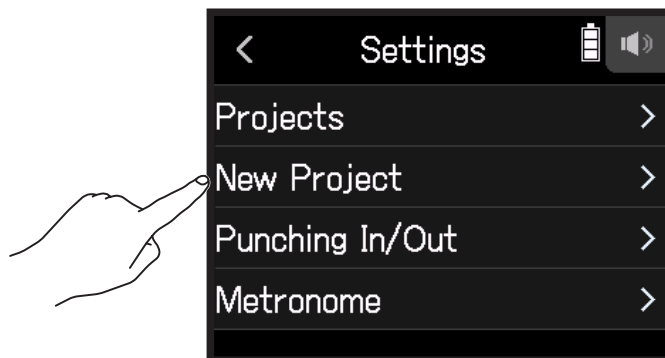

3. Tap **Rec Format**.

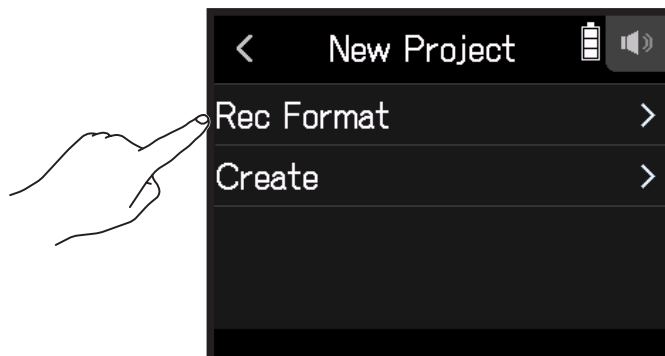

4. Tap a format.

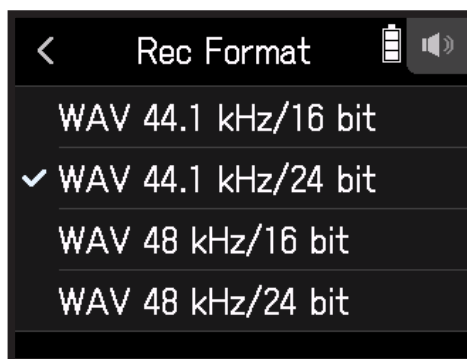

The following formats can be set.

Setting	Explanation
WAV 44.1 kHz/16 bit	The higher the sampling frequency (kHz) and bit rate (bit) are, the better the audio quality will be.
WAV 44.1 kHz/24 bit	
WAV 48 kHz/16 bit	
WAV 48 kHz/24 bit	

NOTE

Effects can only be used when the recording format is 44.1 kHz/16 bit or 44.1 kHz/24 bit.

5. Tap **Create**, and input the project name.

See "Character Input Screen overview" (→ [page 14](#)) for how to input characters.



NOTE

The project created will be set as the recording/playback project.

Opening existing projects

1. Tap .

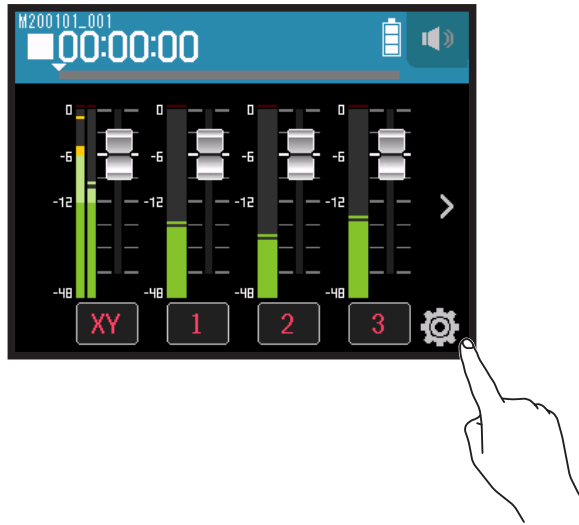

2. Tap **Projects**.

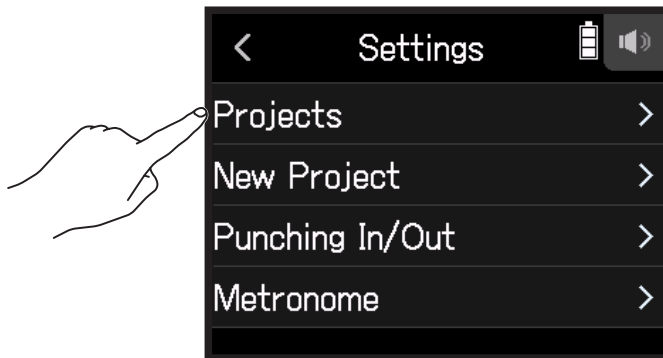

3. Tap  for the project you want to open.

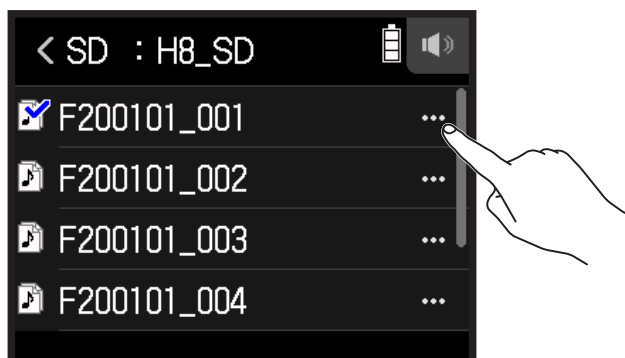

4. Tap **Select**.

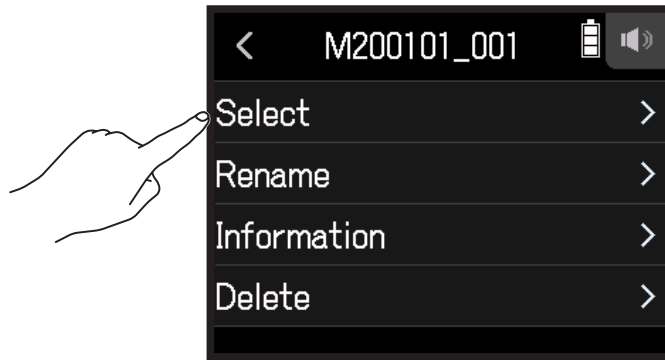

5. Tap **Execute**.

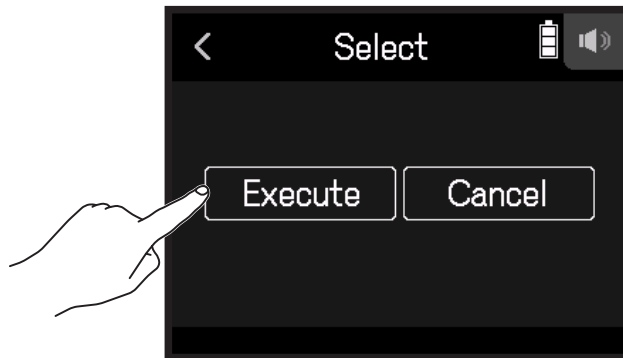

Recording





Recording process

Recording follows the process shown below.



Prepare to record

- Insert an SD card
- Use batteries or an AC adapter
- Connect the mic capsule
- Connect mics, instruments, mixers and other equipment
- Turn the power on
- Create a new project
- Make input and output settings



Record

- Press  followed by  to start recording and  to stop recording
- Press  to pause





Play and check

- Press  to start playback and  to stop
- Project mixer settings can also be made, for example

Record additional files

- Make punch in/out settings
- Press  followed by  to start recording and  to stop recording

Recording

1. Press  on the MUSIC app screen.
This will start recording standby.
2. Press .
This starts recording.
3. Press  to pause.
4. Press  to stop.

NOTE

If the file size exceeds 2 GB during recording, recording will stop automatically.

HINT

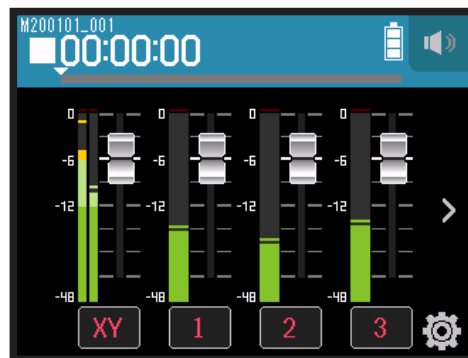

Files are automatically saved at regular intervals during recording. If the power is interrupted or another problem occurs during recording, a file can be restored to normal by assigning the automatically saved file to a track (→ [“Changing files assigned to tracks” on page 74](#)).

Playing recordings



1. Press .

Playback operations

Operation	Touchscreen/button operation
Search forward/backward	Slide  left/right.
Pause/resume playback	Press  .
Stop	Press  / HOME.

HINT

- Slide the progress bar left/right to change the playback position.
- During playback, press track buttons to switch between playing back (lit green) and muted (unlit).
- If the selected project is not valid, an "Invalid Project!" message will appear.

Using effects

There are 76 types of effects that can be used.

1. Tap the desired track button.

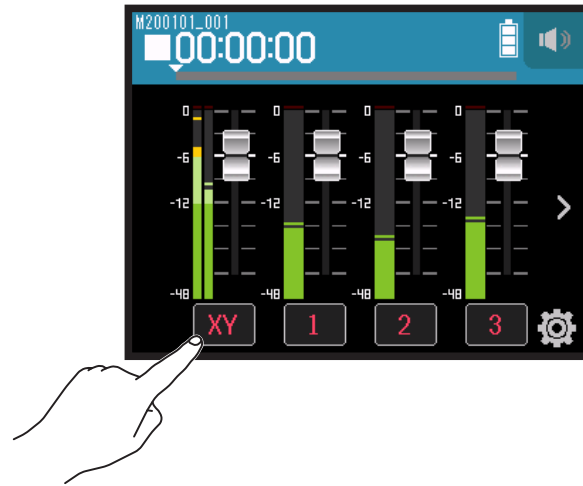

2. Tap  EFFECT.



This opens the Effect Screen.

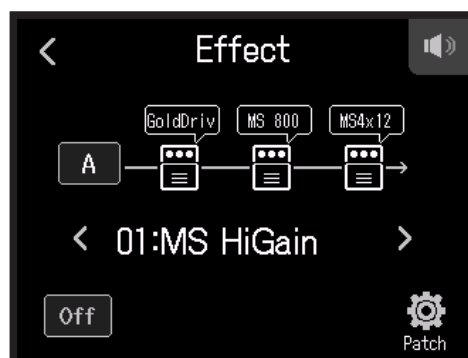

Refer to “Using effects” (→ [page 95](#)) for setting procedures and other details.

NOTE

Effects can only be used when the recording format is 44.1 kHz/16 bit or 44.1 kHz/24 bit.

Using the metronome

The **H8** has a metronome with a precount function. Metronome settings are saved separately with each project.

1. Tap .

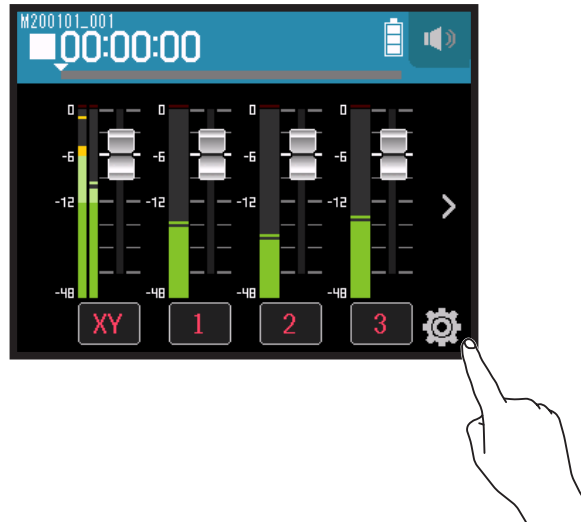

2. Tap **Metronome**.

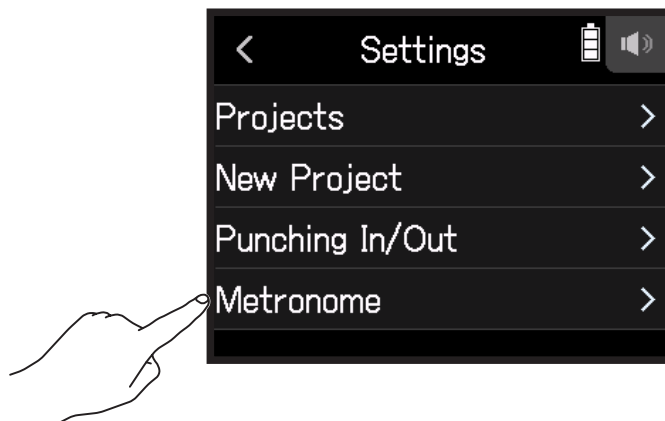

This opens the Metronome Settings Screen.

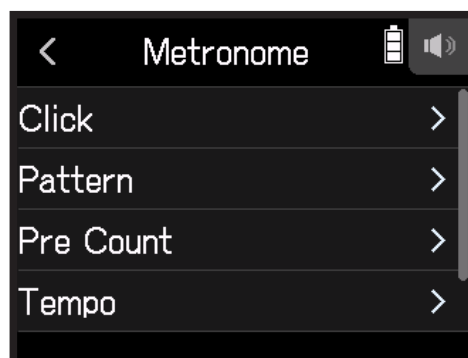

Setting when the metronome sounds

1. Tap **Click** on the **Metronome Settings** Screen.

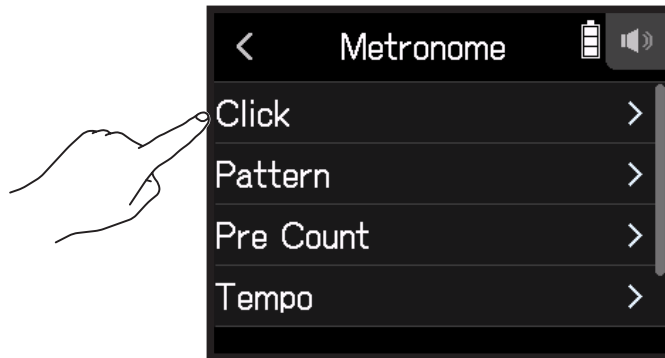

2. Tap a condition to select it. (See the table below.)

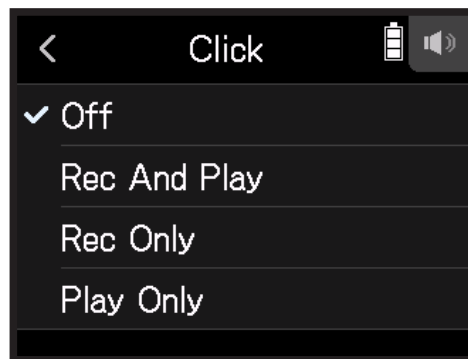

Condition (setting)	Explanation
Off	The metronome does not make sound.
Rec And Play	The metronome sounds during recording and playback.
Rec only	The metronome sounds only during recording.
Play only	The metronome sounds only during playback.

Selecting the metronome pattern

1. Tap **Pattern** on the **Metronome Settings Screen**.

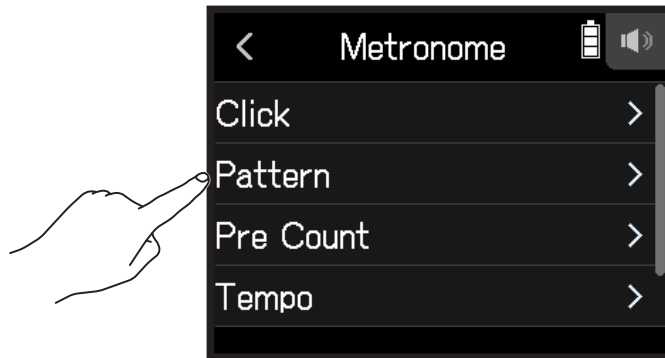

2. Tap a pattern to select it.

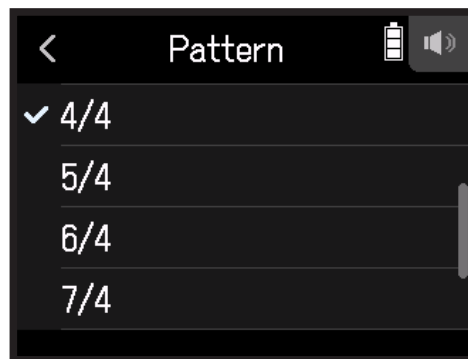

HINT

This can be set to 0/4, 1/4, 2/4, 3/4, 4/4, 5/4, 6/4, 7/4, 8/4 or 6/8.

Setting the precount

A metronome count can be sounded before starting recording/playback.

1. Tap **Pre Count** on the **Metronome Settings Screen**.

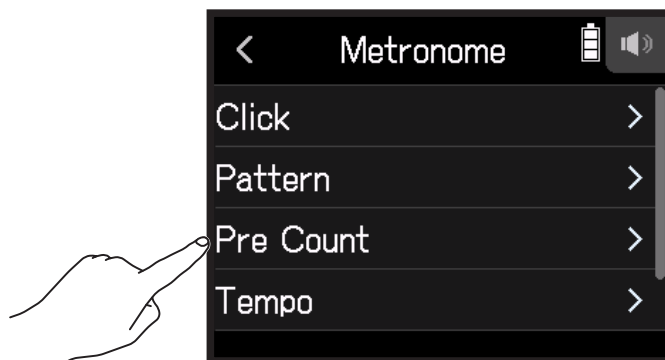

2. Tap a setting to select it. (See the table below.)

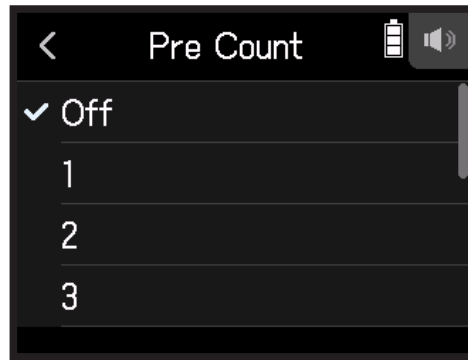

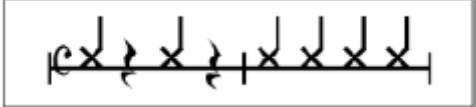

Select a setting from below.

Setting	Explanation
Off	No precount will sound.
1-8	Before recording/playback, the precount will sound for the set number of times (1-8).
Special	Before recording/playback, the precount will sound as shown below. 

Setting the metronome tempo

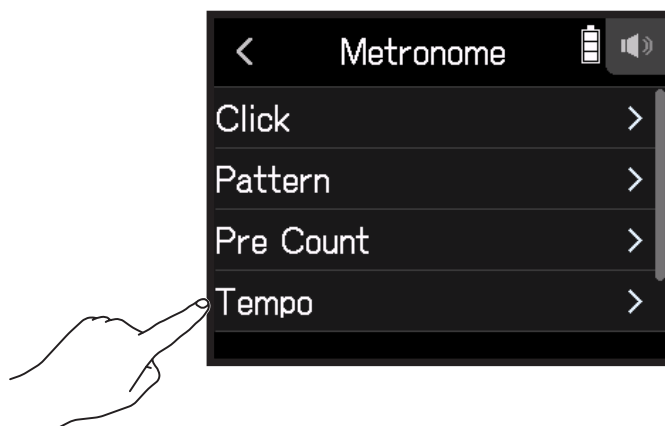
1. Tap **Tempo** on the **Metronome Settings Screen**.



- Slide  up and down to set the desired tempo.





HINT

- This can be set from 40 to 250.
 - The tempo set here will be shared by the effects.
-

Setting the metronome volume

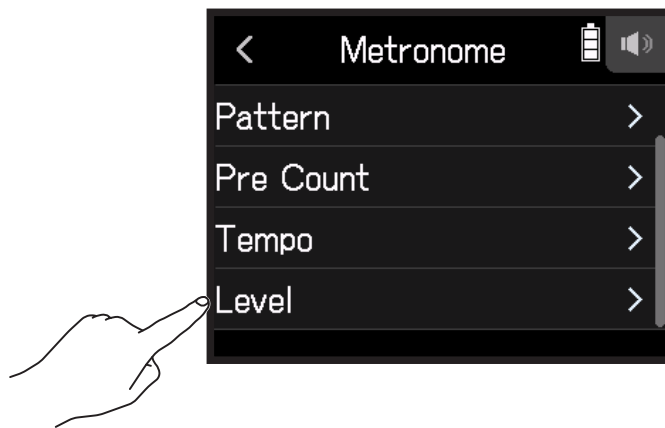
- Tap **Level** on the Metronome Settings Screen.



- Slide  up and down to set the desired volume.

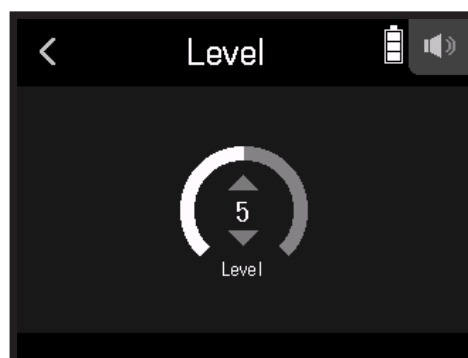

HINT

This can be set from 0 to 10.

Assigning files to tracks

Recording data from tracks in other projects and recorded backup tracks can be freely assigned to tracks and checked during playback.

Changing files assigned to tracks

1. Tap the desired track button.

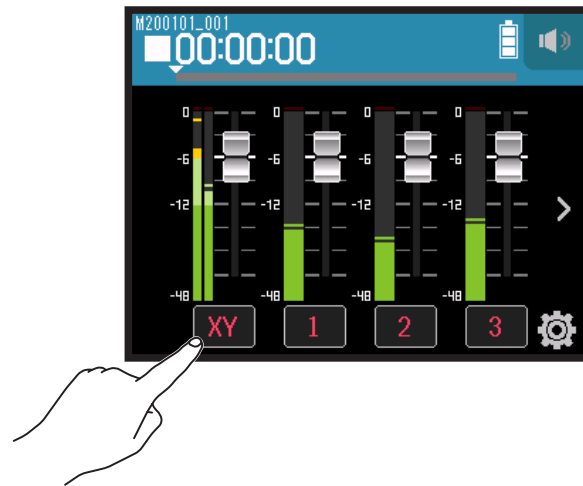

2. Tap  Track Setting.



3. Tap **File Assign**.

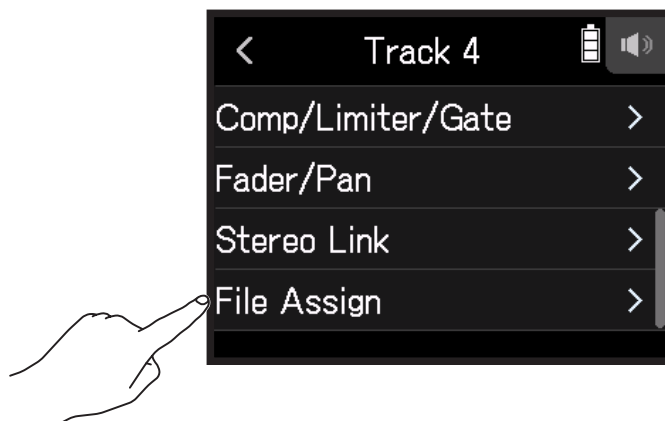

4. Tap **Assign**.

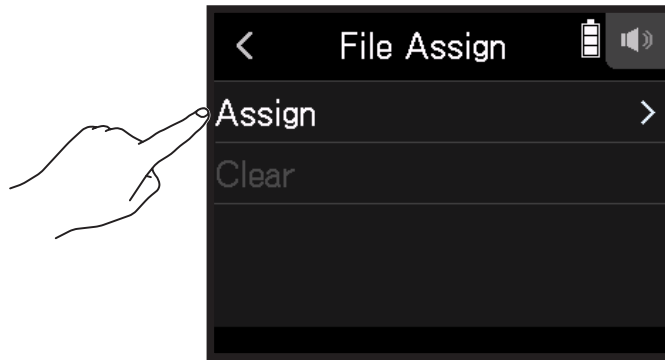

5. Tap the file to assign.

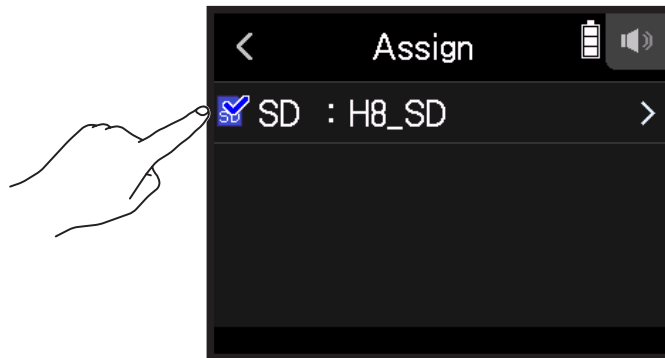

6. Tap **Assign**.

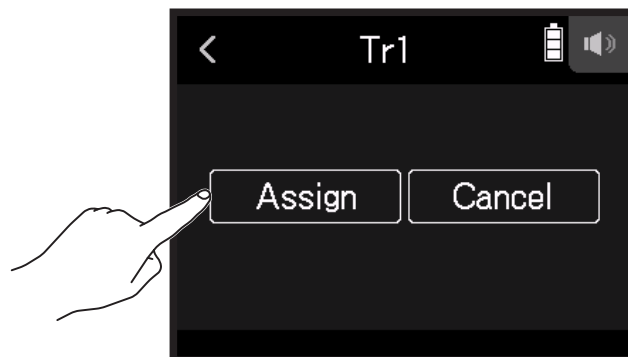

NOTE

When a file is assigned from another project, it will be copied into the currently selected project.

Removing file assignments from tracks

1. Tap the button for the track to change.

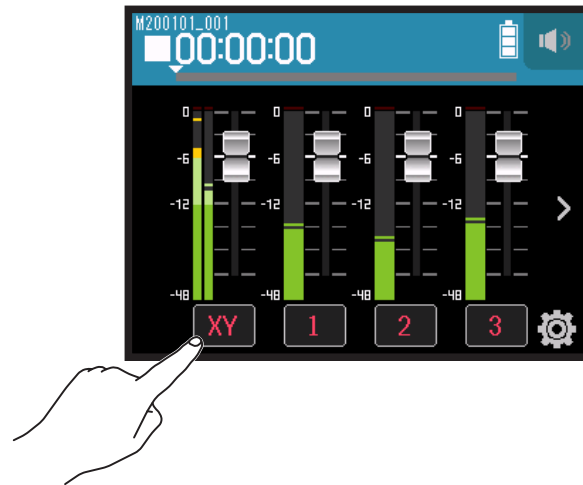

2. Tap  Track Setting.



3. Tap **File Assign**.

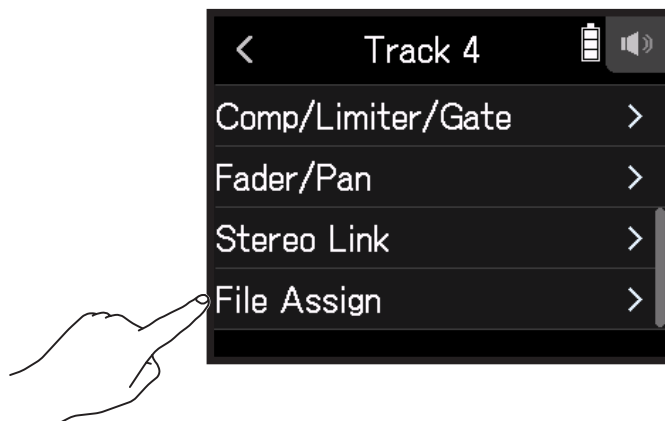

4. Tap **Clear**.

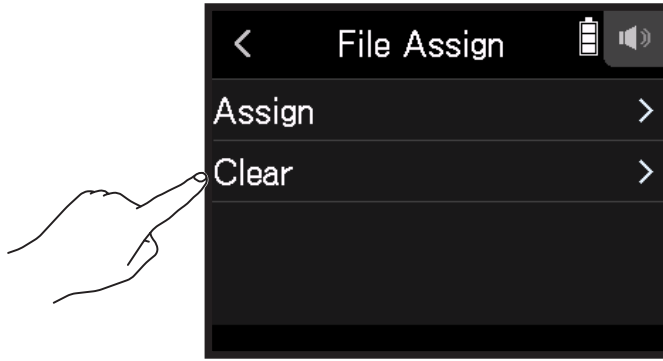

5. Tap **Execute**.

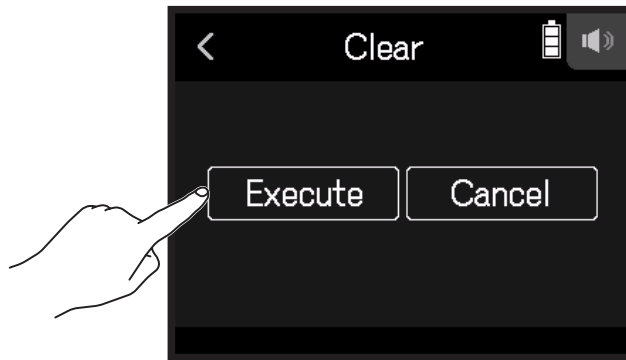

Recording additional files

When **Punching In/Out** is **Off**, new files are always recorded.

When **Punching In/Out** is **On** parts of already recorded tracks can be partially re-recorded.

1. Tap .

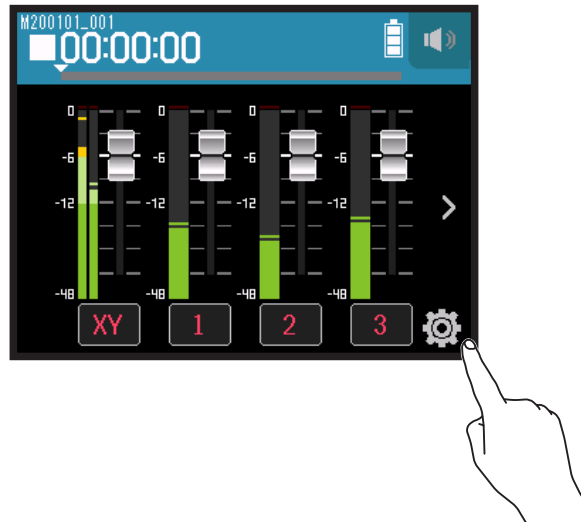

2. Tap **Punching In/Out**.

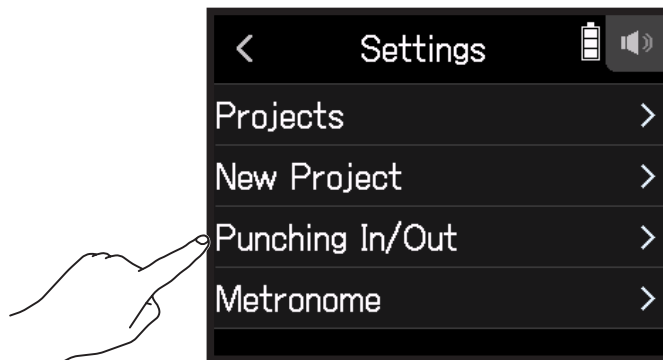

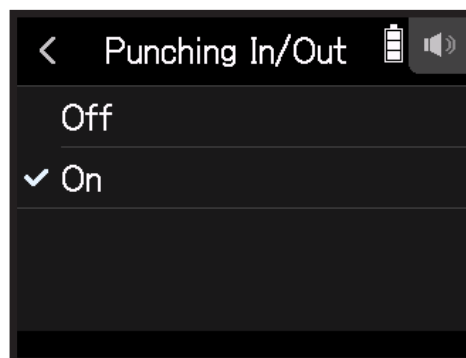

3. Set it to **Off** or **On**.



Setting	Explanation
Off	Always record new files.
On	Parts of already recorded tracks are rerecorded.



Recording new files

1. Tap **Punching In/Out** and set to **Off**.
2. Repeatedly press the track buttons for tracks to rerecord until they light red.
3. Press .
This will start recording standby.
4. Press .
This starts recording.
5. Press  to stop.

Rerecording parts of tracks

Punching in/out is a function that can be used to rerecord parts of already recorded tracks. "Punching in" is switching track status from playback to recording. "Punching out" is switching track status from recording to playback.

With the **H8**, punching in/out can be conducted manually.

1. Tap **Punching In/Out** and set to **On**.
2. Repeatedly press the track buttons for tracks to rerecord until they light red.
3. Press  to start playback.
4. Press  at the position where you want to start rerecording (punch in).
5. Press  at the end of recording (punch out).

NOTE

- Punching in/out can be done once each time playback is started.
- Since punching in/out overwrites part of the file, the previous data will be lost.

Mixing projects

Adjusting track levels

1. Slide track faders up and down to adjust track levels.





HINT

This can be set from $-\infty$ to +10 dB.

Adjusting other settings

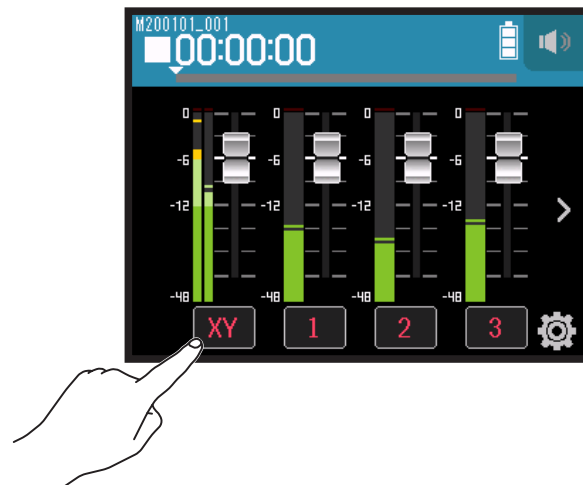
1. Tap the desired track button.



2. Slide  up and down to adjust them, and tap the buttons.



Parameter	Explanation
EQ Low*	<ul style="list-style-type: none"> • This adjusts the boost/cut of low-frequency equalization. • Type: shelving • Gain range: -12 dB – +12 dB • Frequency: 100 Hz
EQ Mid*	<ul style="list-style-type: none"> • This adjusts the boost/cut of mid-frequency equalization. • Type: peaking • Gain range: -12 dB – +12 dB • Frequency: 2.5 kHz
EQ High*	<ul style="list-style-type: none"> • This adjusts the boost/cut of high-frequency equalization. • Type: shelving • Gain range: -12 dB – +12 dB • Frequency: 10 kHz
Pan*	Use this to adjust the left-right balance.
Send*	Use this to adjust the level sent to the send effect.
Track Setting	Use to make input settings. (→ “Making input and output settings” on page 25)
EFFECT	Insert effects can be used. (→ “Using effects” on page 95)

NOTE

*These parameters do not affect individual track recordings. They do affect files created during mixdown. Other parameters do affect individual track recordings.

Mixing down tracks

Recorded projects can be mixed down to stereo files (WAV).

NOTE

Mixing down is not possible when **Punching In/Out** is On.

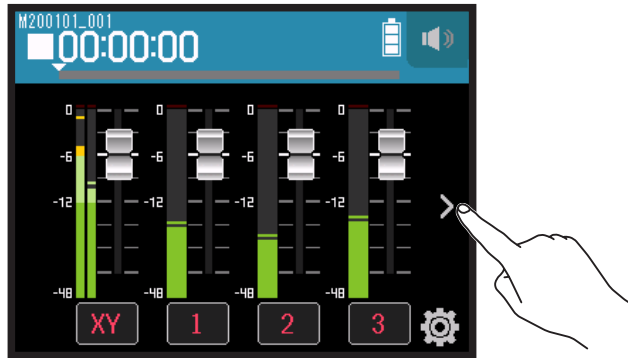

1. Tap the  track display switching button to show the LR track.

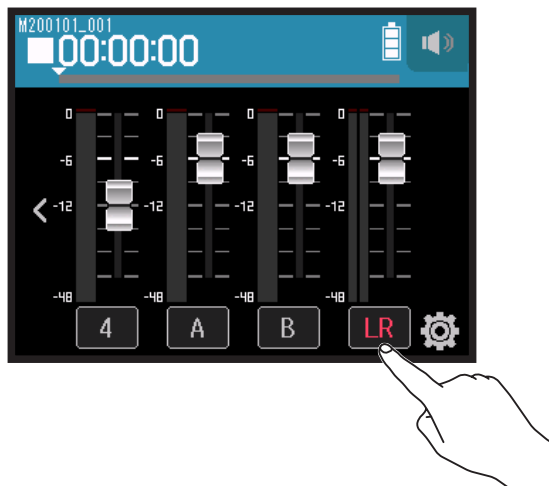

2. Tap the LR track button.



LR will become red.

3. Press .
This will start recording standby.
4. Press .
This starts recording.
5. Press  to stop.

Recording with the PODCAST app

Display overview

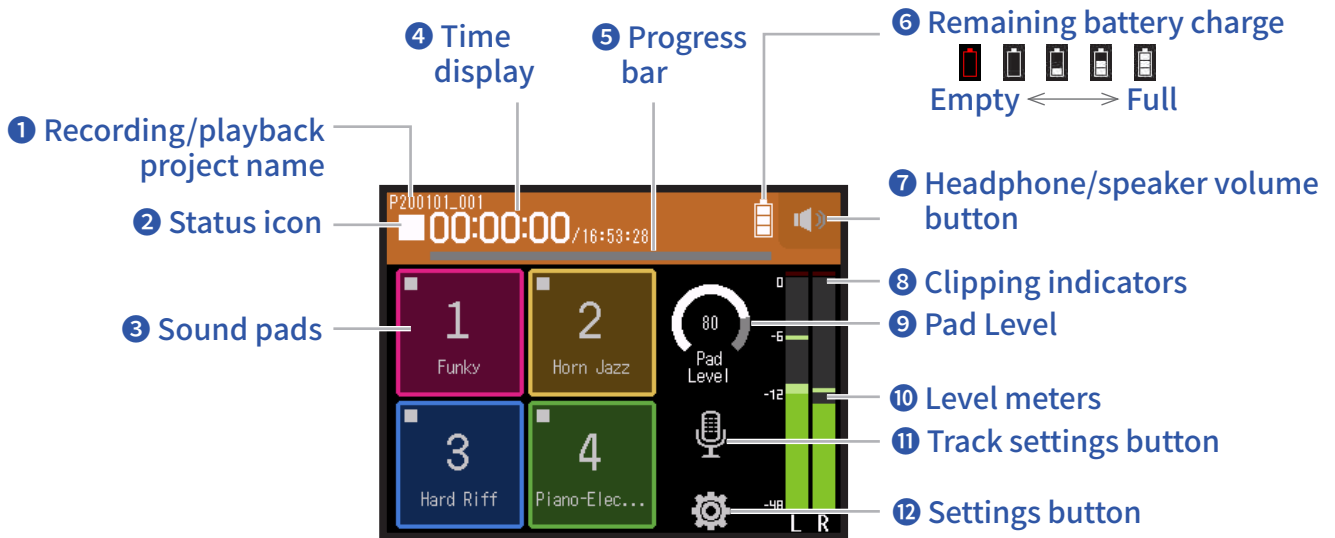

1 Recording/playback project name

2 Status icon

This shows the recording/playback status.

■ : Stopped ● : Recording || : Recording/playback paused ► : Playing

3 Sound pads

Sounds assigned to each pad can be played.

4 Time display

00:00:00/00:00:00

When recording

Left: Current elapsed recording time

Right: Remaining available recording time

When playing

Left: Current elapsed playback time

Right: Remaining playback time

5 Progress bar

This shows the current playback location.

Mark positions are shown above the progress bar.

Slide  to change the playback position.

6 Remaining battery charge

This shows the remaining battery charge. When the remaining battery charge becomes low, replace the batteries (→ [“Using batteries” on page 17](#)) or connect an AC adapter (→ [“Using an AC adapter” on page 17](#)).

7 Headphone/speaker volume button

Touch this to show the headphone/speaker volume slider. (→ [page 42](#))

8 Clipping indicators

If a clipping indicator lights, adjust the input level (→ [“Setting recording \(input\) levels” on page 26](#)) or set the limiter (→ [“Comp/Limiter/Gate” on page 34](#)).

9 Pad level

Use this to adjust the sound pad level.

10 Level meters

These are the level meters for the LR track.
When the LR track is on, LR becomes red.

11 Track settings button

Press to make track settings, including Lo Cut and Phantom functions. (→ [page 27](#))

12 Settings button

Press to access a list of projects on the SD card (→ [page 107](#)) and to make recording format settings (→ [page 91](#)).

Recording



Recording process

Recording follows the process shown below.

Prepare to record

- Insert an SD card
- Use batteries or an AC adapter
- Connect the mic capsule
- Connect mics, instruments, mixers and other equipment
- Turn the power on
- Set the recording format
- Make input and output settings

Record

- Press  to start recording and press  to stop recording
- Sound pads can also be recorded
- Marks can also be added
- Press  to pause

Play and check

- Press  to start playback and  to stop
- Cue to mark positions and to make project mixer settings, for example

Recording

1. Press  on the PODCAST app screen.

This starts recording.

NOTE

- When sound pads are used during recording, their sounds are mixed in stereo and recorded on tracks 3/4.
- In PODCAST mode, Inputs 3/4 cannot be used.

2. Press  to pause.

NOTE

- When recording is paused, a mark is added at that point. Press  again to resume recording.
- A maximum of 99 marks can be added in a project.

HINT

Marks can be added without pausing. (→ [“Setting how marks are added when recording/playing” on page 135](#))

3. Press  to stop.

NOTE

If the file size exceeds 2 GB during recording, recording will continue in a new project with a number that is one higher. No gap in sound will occur between the two projects when this happens.

HINT







Files are automatically saved at regular intervals during recording. If the power is interrupted or another problem occurs during recording, a file can be restored to normal by assigning the automatically saved file to a track (→ [“Changing files assigned to tracks” on page 74](#)).

Playing recordings





1. Press .

Playback operations

Operation	Touchscreen/button operation
Select playback project/move to mark	Tap 
Search forward/backward	Press and hold  Slide  left/right.
Skip 15 seconds	Tap 
Pause/resume playback	Press 
Stop	Press 

HINT

- Slide the progress bar left/right to change the playback position.
 - During playback, press track buttons to switch between playing back (lit green) and muted (unlit).
 - If the selected project is not valid, an "Invalid Project!" message will appear.
 - If no playable project exists, a "No Project!" message will appear.
 - During playback, press  to add marks that can be used for cueing. (→ ["Setting how marks are added when recording/playing" on page 135](#))
-

2. Press  to return the top screen of the PODCAST app.

Using sound pads

Audio files (WAV format) can be assigned to the sound pads. Tap one to play the assigned file. These are useful, for example, for playing effect sounds during podcasting and streaming as well as during live theater and music performances.

NOTE

- When sound pads are used during recording, their sounds are mixed in stereo and recorded on tracks 3/4.
- In PODCAST mode, Inputs 3/4 cannot be used.

Playing sounds with sound pads

When shipped new from the factory, the **H8** has 13 built-in sounds, and 4 are pre-assigned to sound pads.

1. Tap a sound pad.



NOTE

When sound pads are played during recording, they will be recorded on tracks 3/4.

HINT

Slide the **Pad Level** knob up and down to adjust the overall level of the pads.

Assigning audio files to sound pads

Built-in sounds and audio files saved on an SD card can be assigned to sound pads.

1. Tap .

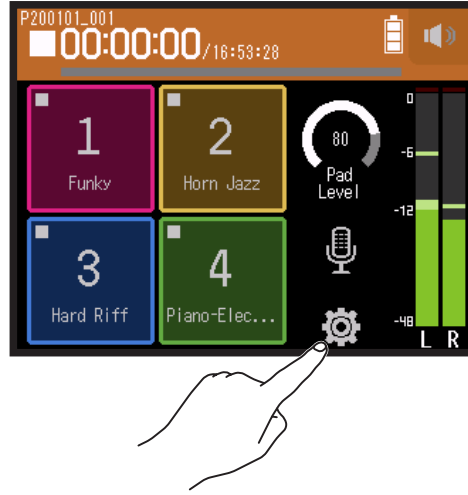

2. Tap **Sound Pad Assign**.

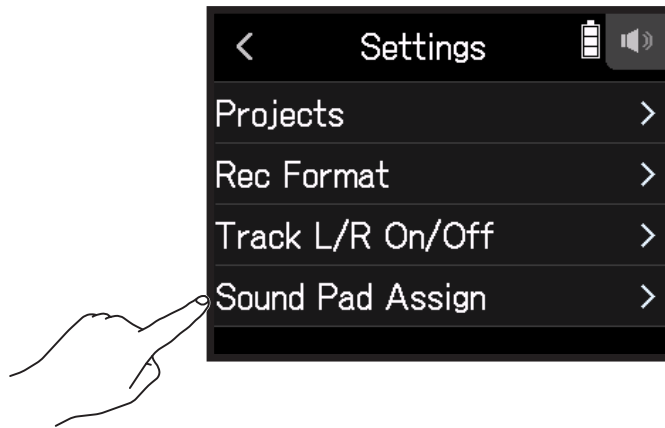

3. Tap the number of the pad to be reassigned.

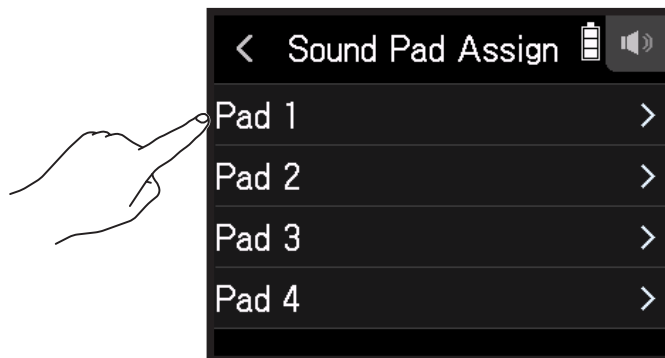

4. Tap **Preset** or **SD CARD**.

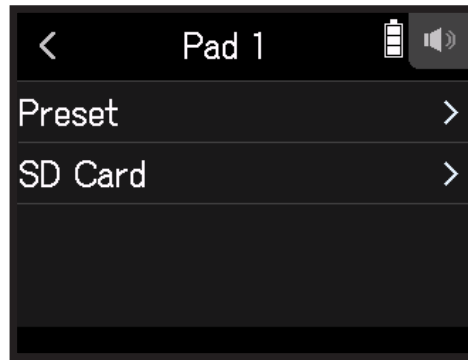

5. Tap the desired file.

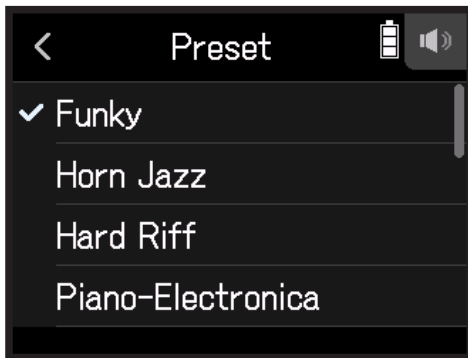

6. Tap **Assign**.

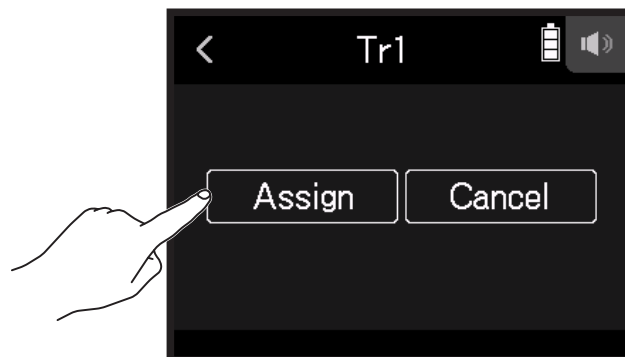

NOTE

- Use a computer to store audio files for sound pad assignment in the SOUND PAD folder on the card. (→ [“Using as a card reader” on page 122](#))
- Sound pads support the following file types.
 - File format: WAV
 - Sampling rate: 44.1/48 kHz
 - Bit rate: 16/24-bit
 - Channels: Mono/stereo
- Files that are not inside the SOUND PAD folder will be copied to the SOUND PAD folder when they are assigned.

Making recording settings

Setting the recording format

Considering audio quality and file size, select the format.

1. Tap .

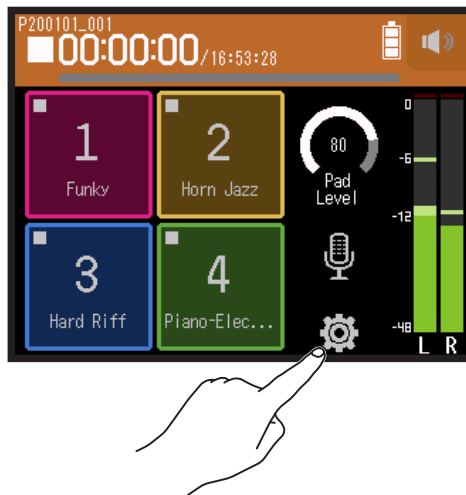

2. Tap **Rec Format**.

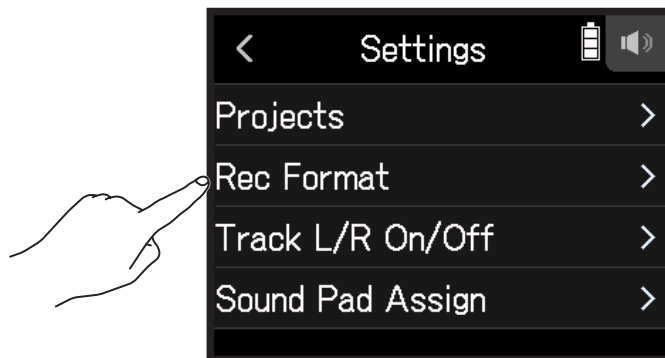

3. Set the recording format

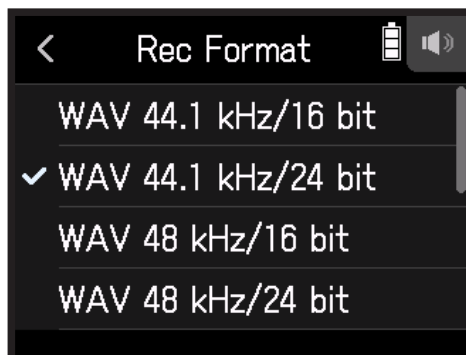

The following formats can be set.

Setting	Explanation
WAV 44.1 kHz/16 bit	The larger the number, the higher the sound quality, and the larger the file size.
WAV 44.1 kHz/24 bit	
WAV 48 kHz/16 bit	
WAV 48 kHz/24 bit	
MP3 128 kbps	
MP3 192 kbps	
MP3 320kbps	

Recording L/R tracks

During recording, a stereo file can be created based on the mix from the internal mixer.

1. Tap .

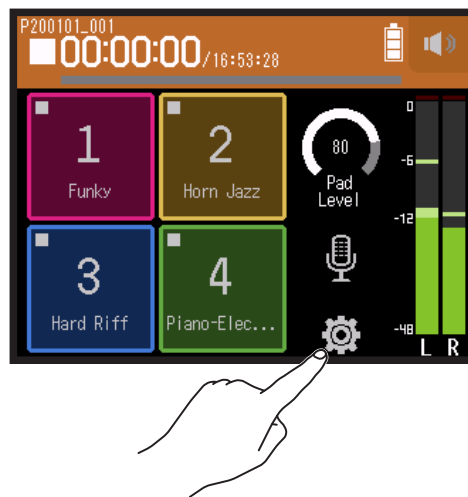

2. Tap **Track L/R On/Off**.

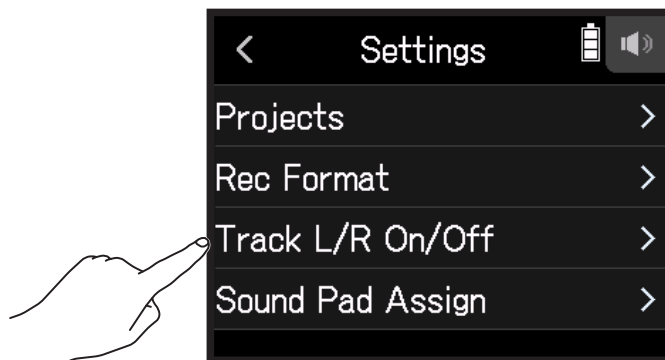

3. Tap On.

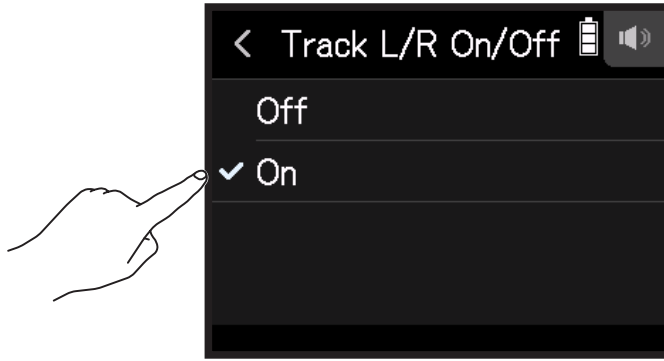

Using effects

There are 76 types of effects that can be used.

1. Tap .



2. Select a track.

3. Tap **Effect**.

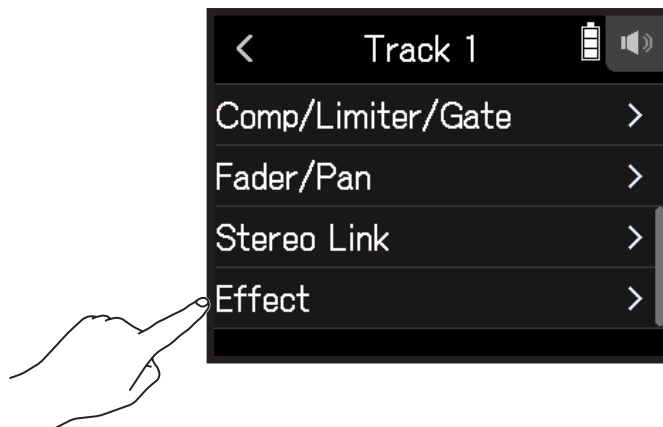

This opens the Effect Screen.

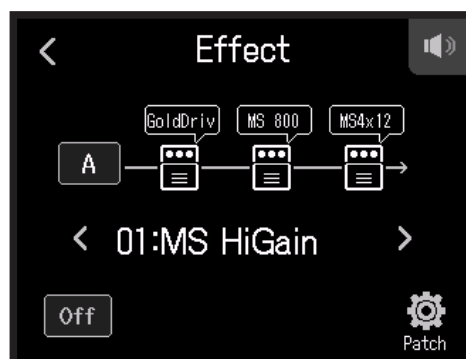

Refer to "Using effects" (→ [page 95](#)) for setting procedures and other details.

NOTE

Effects can only be used when the recording format is 44.1 kHz/16 bit or 44.1 kHz/24 bit.

Using effects

These alter the sounds of instruments, voices and other sources. The included effects, which are equivalent to those in ZOOM multi-effects processors, can be used with a variety of instruments. Using the free Guitar Lab effect management application on a computer (Mac/Windows), you can add effects that are distributed online as well as edit and back up patch memories, for example.

Selecting tracks and patch memories to use effects

Setting tracks to use effects from the MUSIC app screen

1. Select a track.

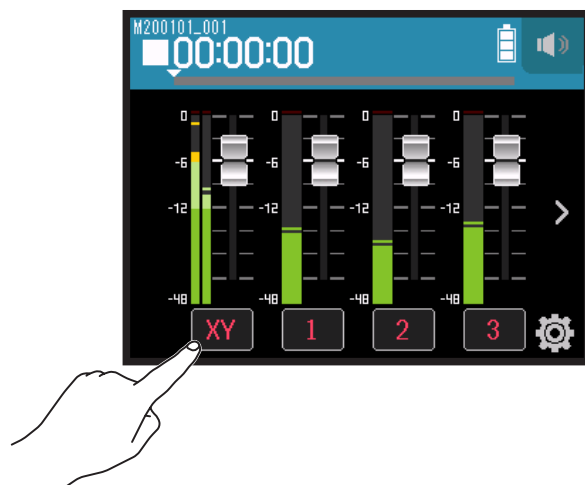

2. Tap  EFFECT.

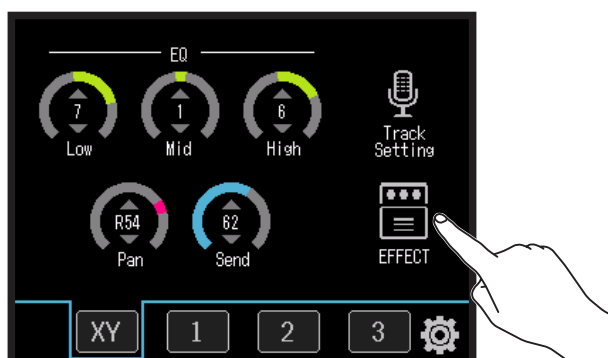

This opens the Effect Screen.

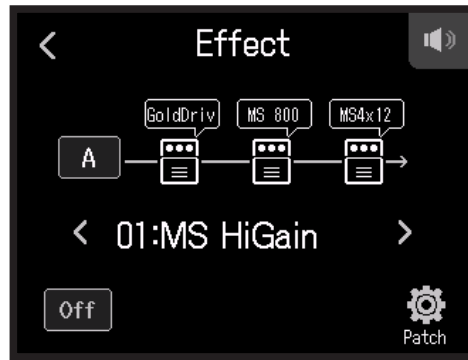

3. Tap the input icon.

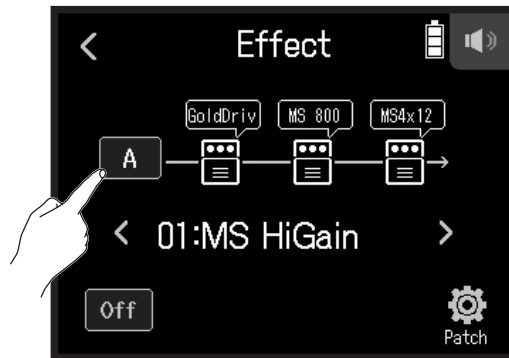

4. Select the track to use the effect on.

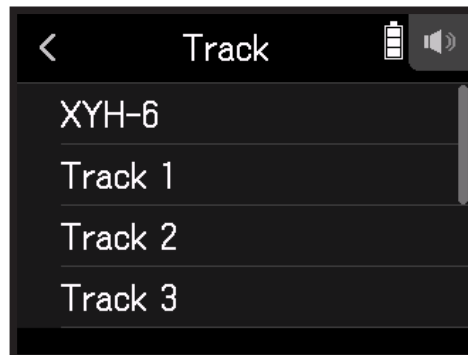

Setting tracks to use effects from the PODCAST app screen

1. Tap .



2. Select a track.

3. Tap **Effect**.

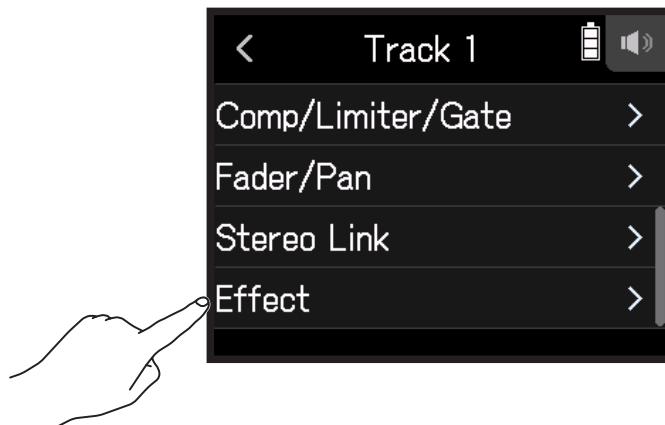

This opens the Effect Screen.

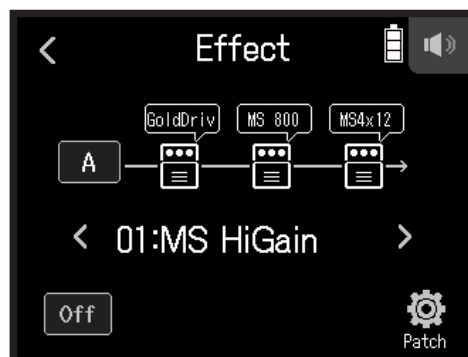

4. Tap the input icon.

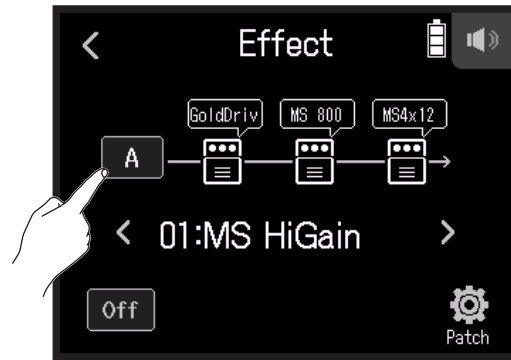

5. Select the track to use the effect on.

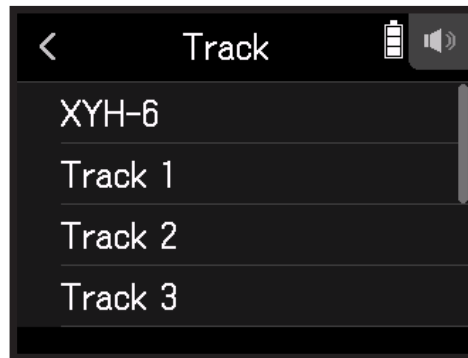

Selecting patch memories and turning them on/off

1. Tap < and > on the Effect Screen to select a patch memory.

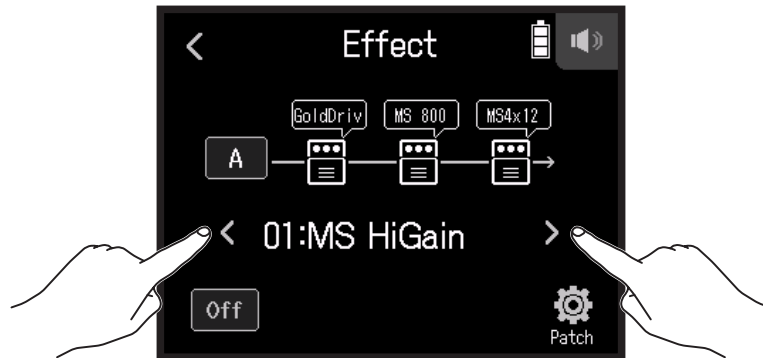

2. Tap On/Off.

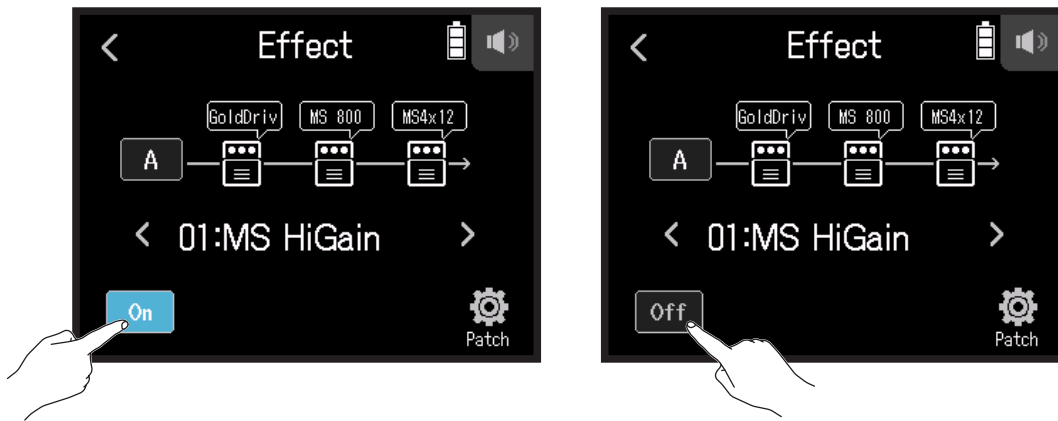

Adjusting effect parameters

1. Tap the effect to adjust on the Effect Screen.

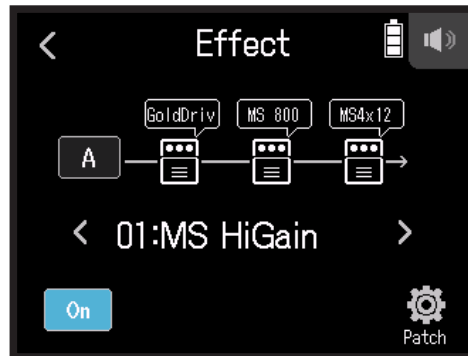

2. Adjust the effect.



- Tap **On/Off** to change its on/off setting.
- Tap **Type** to change the effect.
- Slide parameters up and down to adjust their settings.

NOTE

- If there are five or more parameters, tap **>** to change the screen.
- Using the **H8**, you can combine three effects as you like. If the processing capability limit is exceeded, however, a "Process Overflow. Change effect" warning will appear and effects will be bypassed. Change one of the effects to end this condition.
- The parameters that can be adjusted depend on the effect.

Making patch memory settings

Saving patch memories

1. Tap  Patch on the Effect Screen.

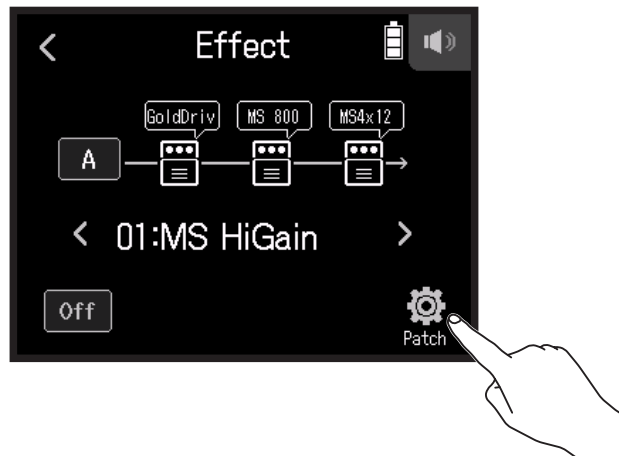

2. Tap **Save**.

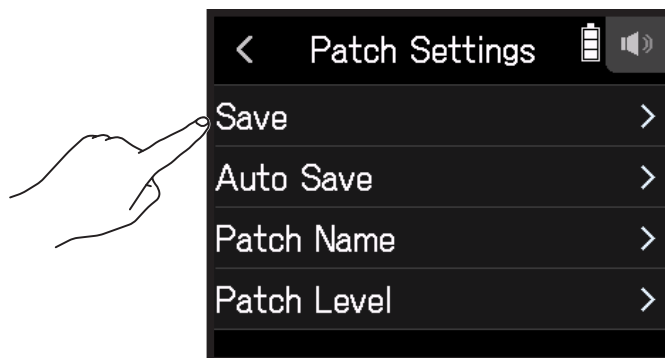

3. Tap the name of the save destination patch.

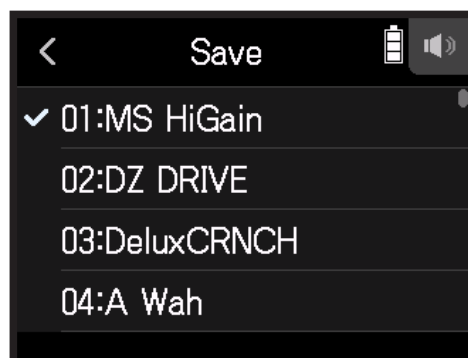

4. Tap **Execute**.

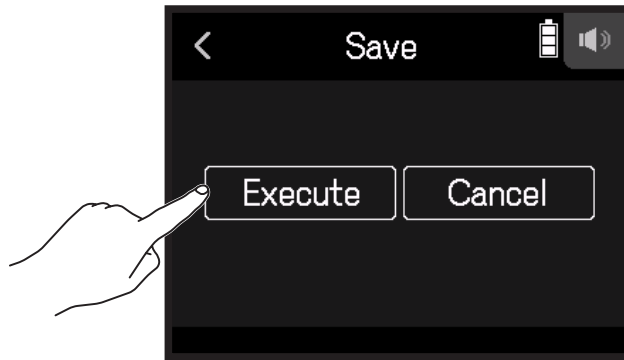

NOTE

- Patch memories are not saved in projects.
- 50 patch memories can be saved as **H8** settings.

Saving patch memories automatically

This setting can be made to automatically save patch memories when they are changed.

1. Tap  **Patch** on the Effect Screen.

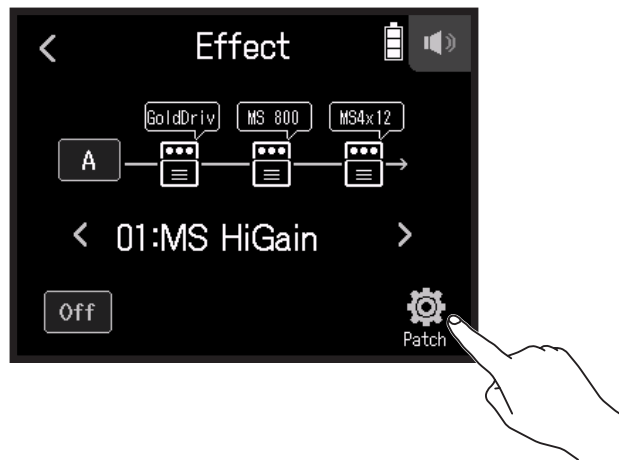

2. Tap **Auto Save**.

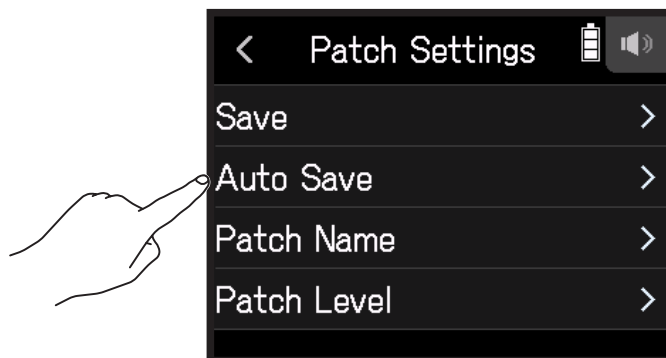

3. Tap **On**.

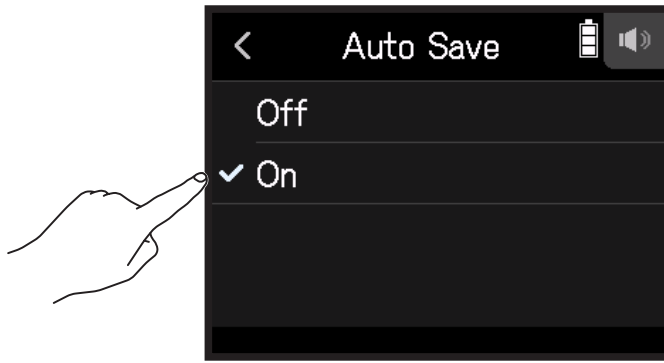

Changing patch names

1. Select the patch memory with the name you want to change on the Effect Screen.

2. Tap  **Patch**.

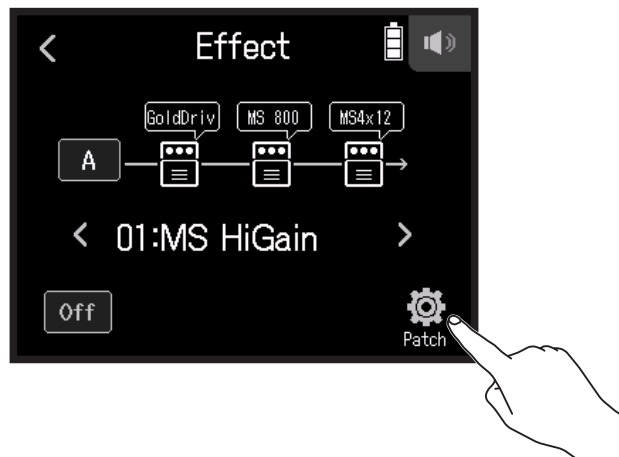

3. Tap **Patch Name**.

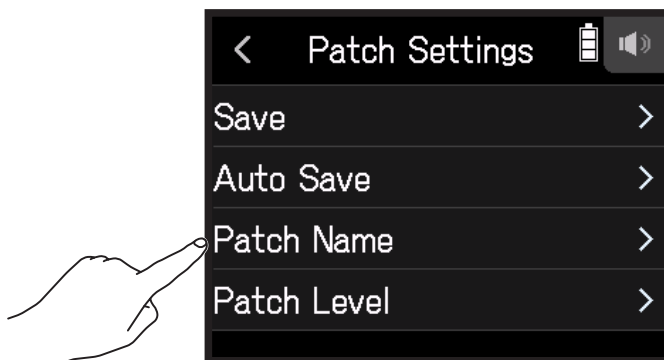

4. Input the patch name, and tap **Enter**.



See "Character Input Screen overview" (→ [page 14](#)) for how to input characters.

Changing patch levels

1. Tap  **Patch** on the Effect Screen.

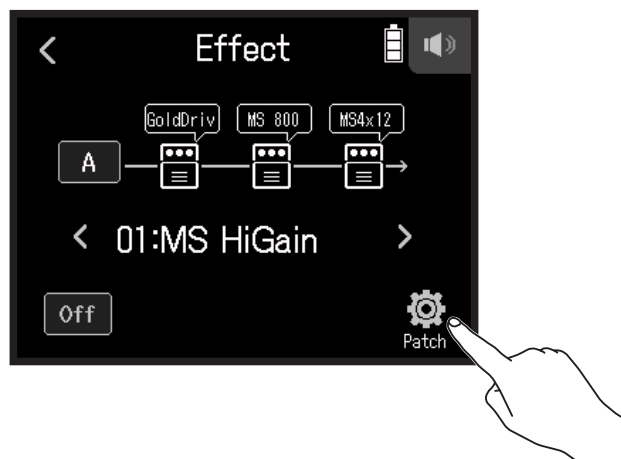

2. Tap **Patch Level**.

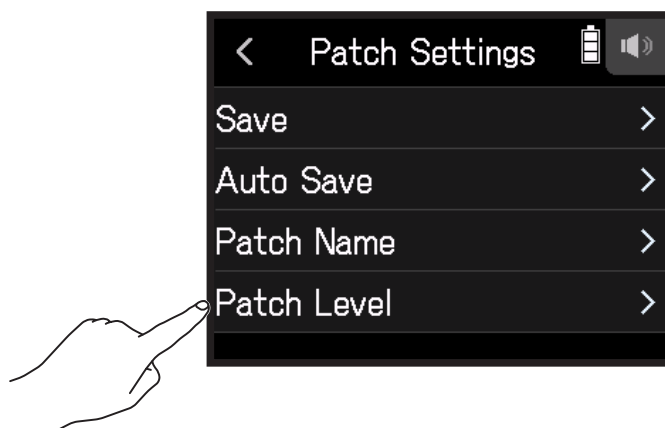

3. Slide  up and down to change the level.



Managing projects

Folder and file structure

When recording with the **H8**, folders and files are created on SD cards in the following manner.

Projects that are created can be used with all three apps (FIELD, MUSIC and PODCAST). (Recording and playback of 96kHz/16-bit and 96kHz/24-bit WAV files is only supported by the FIELD app.)

The **H8** manages recording and playback data in units called projects.

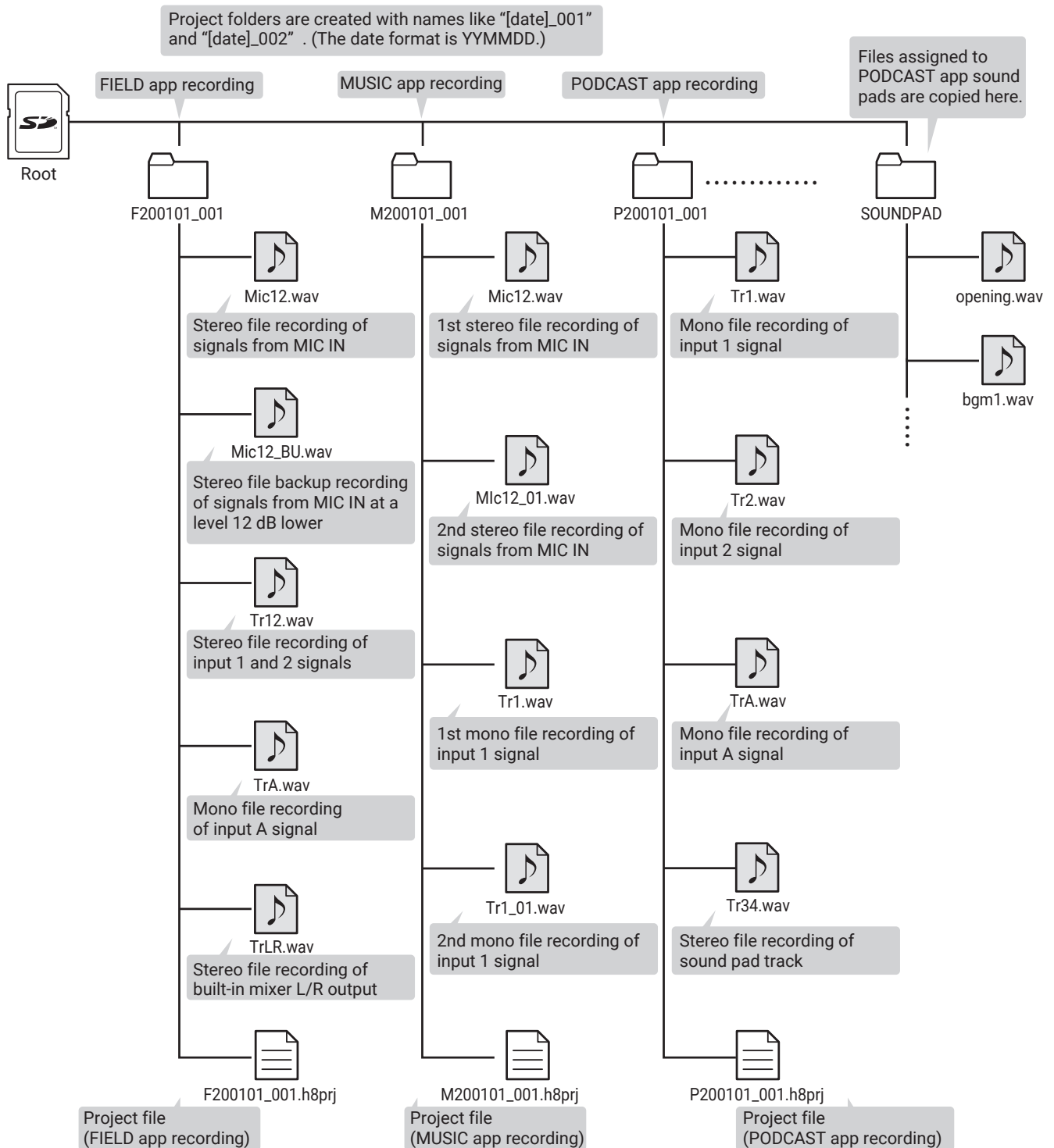

Managing projects

The contents of SD cards can be viewed and folders can be created. Recording/playback folders can also be set and deleted and have their information checked, for example.

Project Operation Screen

1. Tap  on an app screen.

2. Tap **Projects**.

The Project Operation Screen shows the folders and files on the SD card.

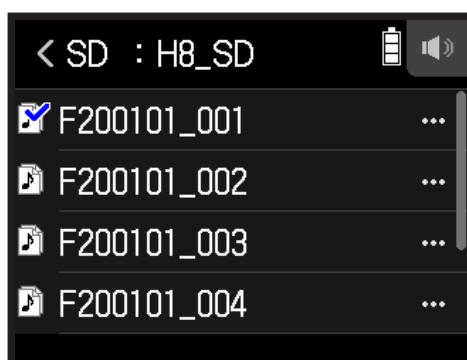

• The following operations are possible.

Action	Operation
Move down a level	Tap a folder
Move up a level	Tap <
Show options	Tap ...

Selecting the project recording/playback folder

Select the folder that contains the project to be played and to use for recording projects, and return to the top screen of the app.

1. Tap **...** on the Project Operation Screen.



2. Tap **Select**.

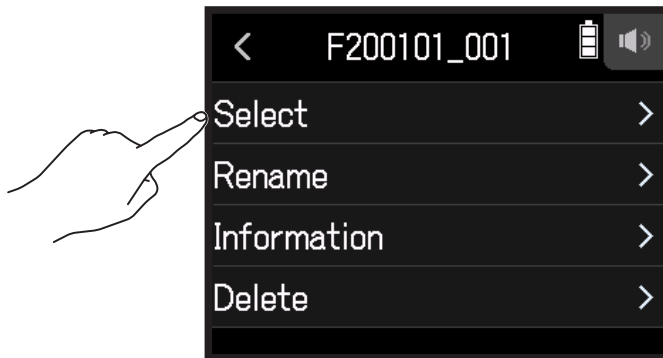

3. Tap **Execute**.

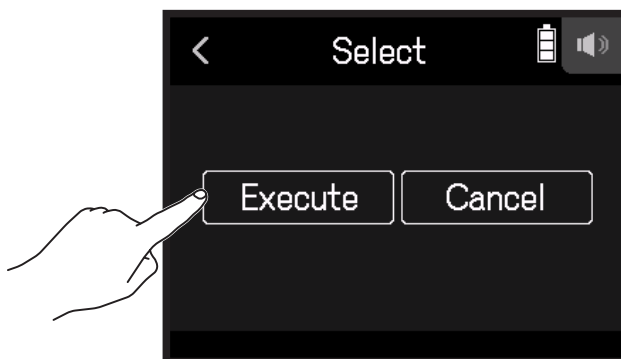

NOTE

When a folder is selected, the first project inside the selected folder will be set as the playback project.

Changing folder and project names

1. Tap **...** on the Project Operation Screen.



2. Tap **Rename**.

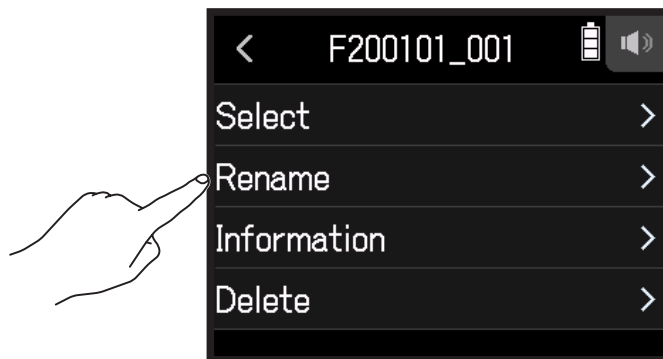

3. Input the folder/project name.



See "Character Input Screen overview" (→ [page 14](#)) for how to input characters.

Checking project information

1. Tap  on the Project Operation Screen.



2. Tap  Information.

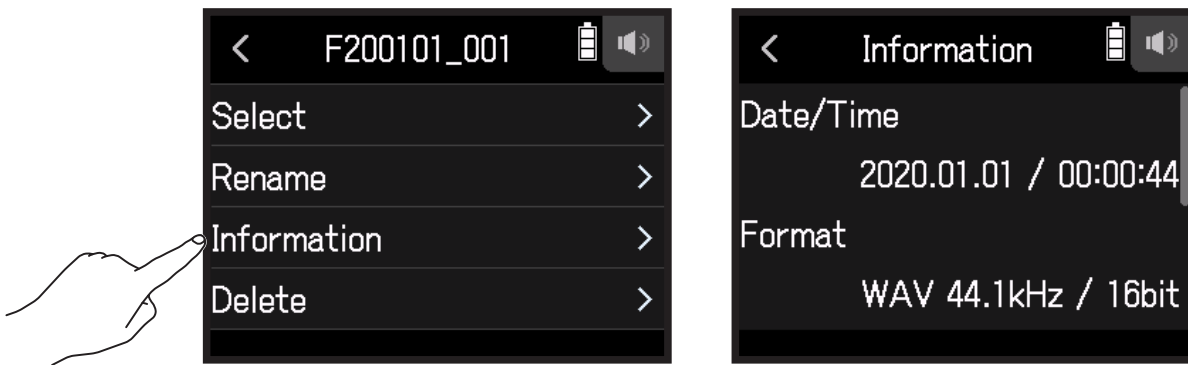

Item	Explanation
Date/Time	Date and time recorded
Format	Recording format
Size	Recording file size
Length	Recording time

Deleting folders and projects

1. Tap **...** on the Project Operation Screen.



2. Tap **Delete**.

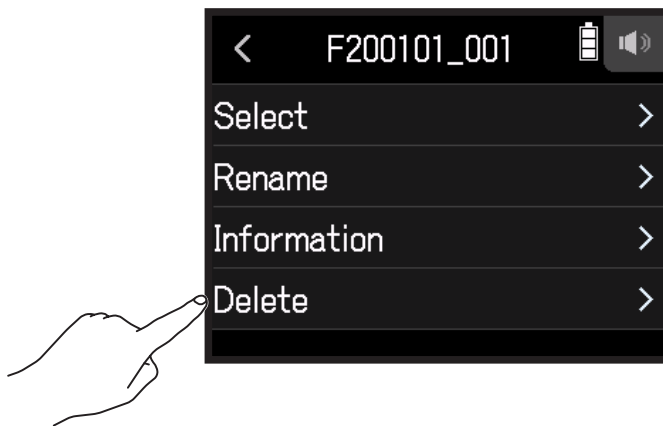

3. Tap **Execute**.

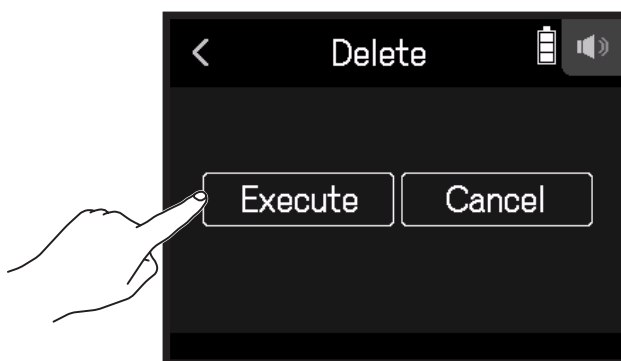

Using as an audio interface

Signals input to the **H8** can be input to a computer or iOS/iPadOS device. Moreover, signals played back on a computer or iOS/iPadOS device can be output from the **H8**.

Connecting the H8 with a computer or iOS/iPadOS device

1. Tap  **AUDIO INTERFACE** on the Home Screen.

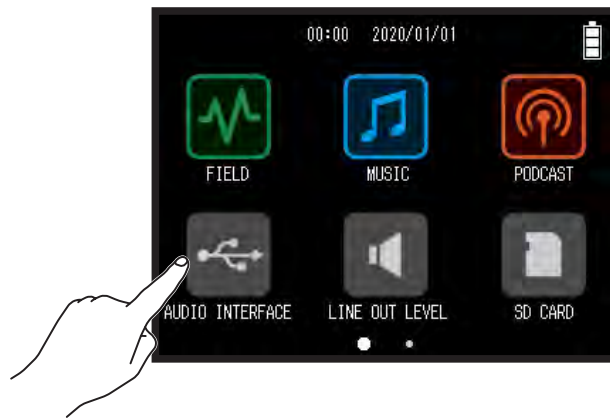

2. Select the mode.

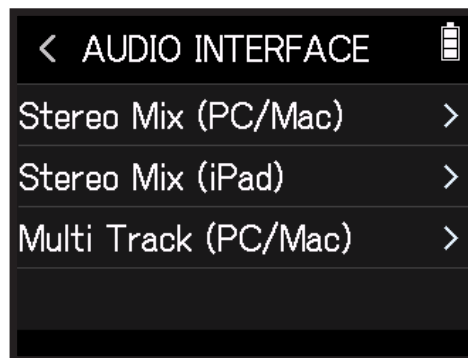

Mode	Explanation
Stereo Mix (PC/Mac)	This is a 2-in/2-out connection mode for Mac/Windows that sends all tracks as a stereo mix.
Stereo Mix (iPad)	This is a 2-in/2-out connection mode for iPadOS devices that sends all tracks as a stereo mix.
Multi Track (PC/Mac)	This is a 12-in/2-out connection mode for Mac/Windows that sends the signals of each track separately.

NOTE

A driver is necessary for use with Windows. Download the driver from the ZOOM website (zoomcorp.com).

If a Stereo Mix has been selected, skip to step 5.

3. Tap **Sample Rate**, and select a sample rate.

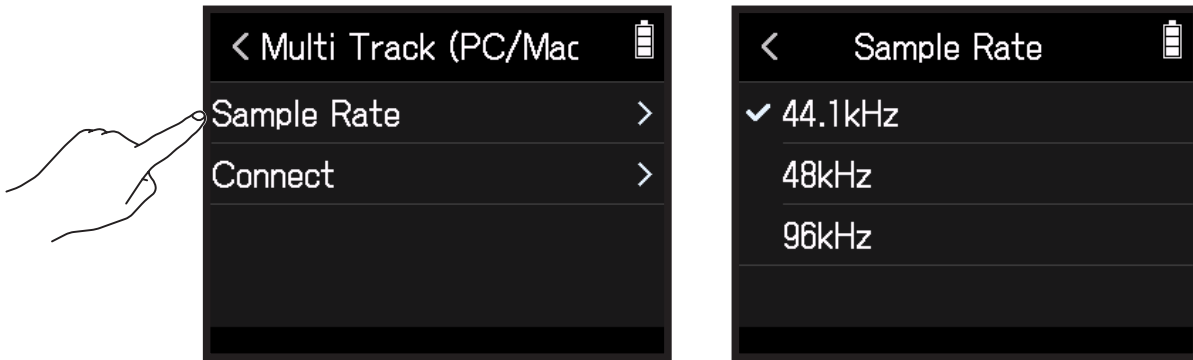

4. Tap **Connect**.

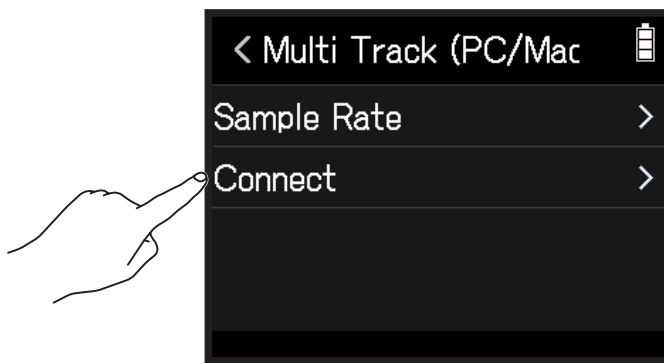

5. Use a USB cable to connect the **H8** with a computer or iOS/iPadOS device.

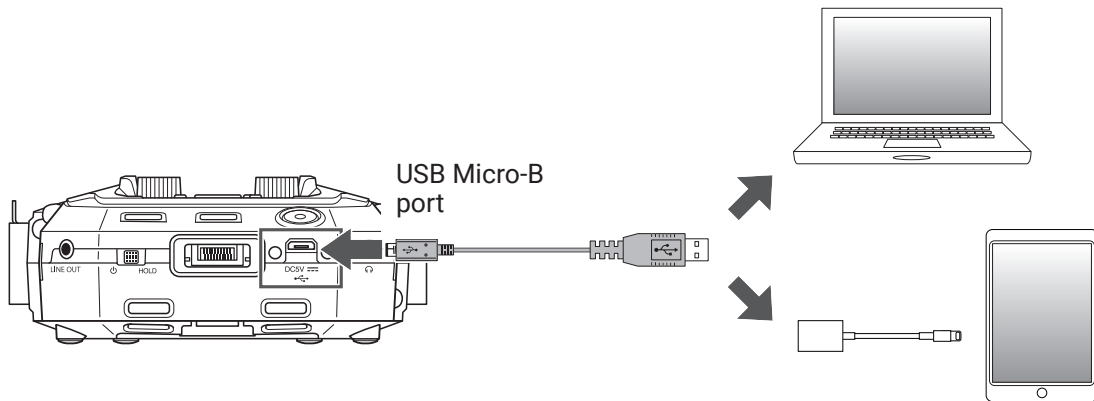

NOTE

Use a Lightning to USB Camera Adapter (or Lightning to USB 3 Camera Adapter) to connect to an iOS/iPadOS device with a lightning connector.

Disconnecting from a computer or iOS/iPadOS device

1. Tap  on the audio interface top screen.

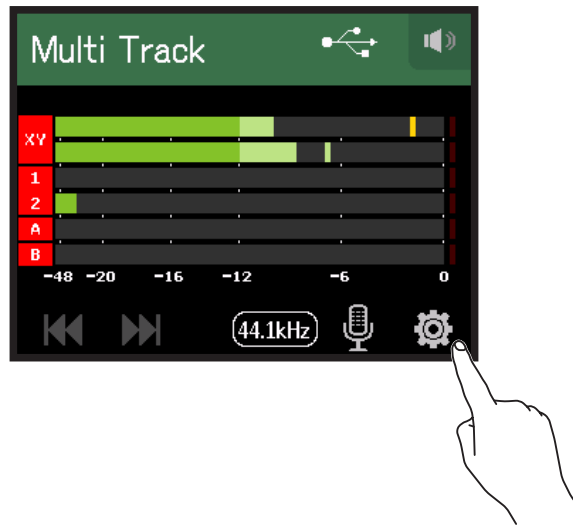

2. Tap **Exit**.

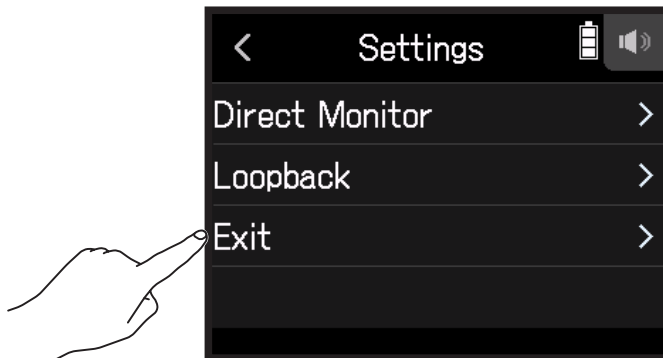

3. Tap **Execute**.

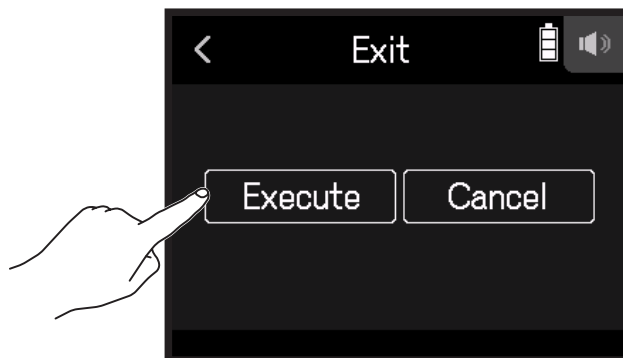

4. Disconnect the USB cable connecting the **H8** with a computer or iOS/iPadOS device.

Making audio interface settings

The following two settings can be made when using the **H8** as an audio interface.

Enabling direct monitoring

This directly outputs the sound being recorded through the **H8** from the **H8** before sending it to the computer or iOS/iPadOS device. This enables monitoring without latency.

1. After connecting a computer or iOS/iPadOS device, tap  on the app screen.
2. Tap **Direct Monitor**, and set it to **On**.

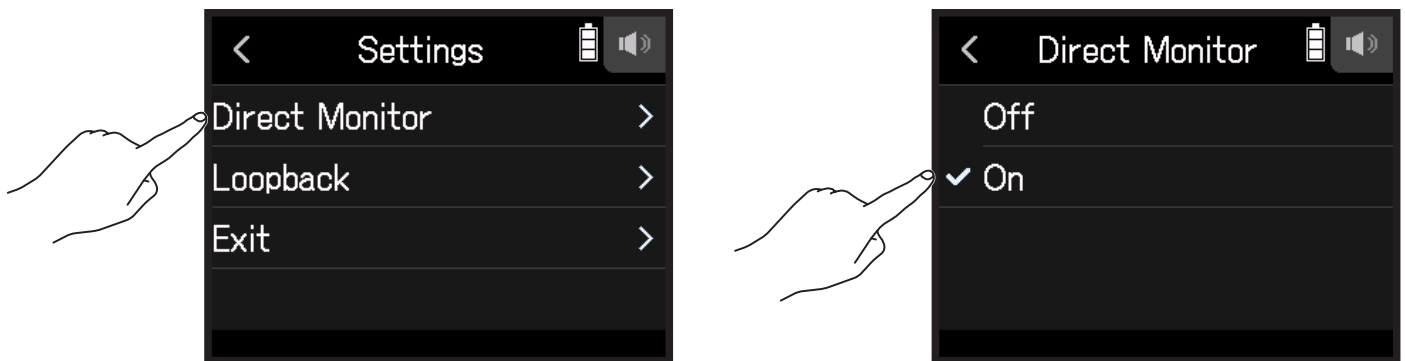

Setting loop back (Stereo Mix only)

This function mixes the playback sound from the computer or iOS/iPadOS device with the **H8** input and sends the mix back to the computer or iOS/iPadOS device (loop back).

This function can be used to add narration to music played back from the computer and to record the mix or stream it on the computer, for example.

1. After connecting a computer or iOS/iPadOS device, tap  on the app screen.
2. Tap **Loopback**, and set it to **On**.

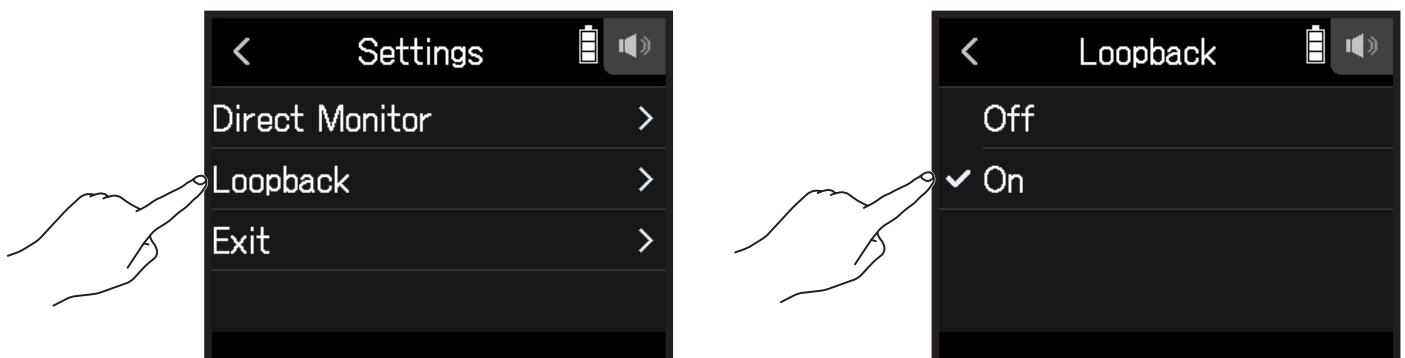

Mixing inputs

The mix balance of the inputs can be adjusted. Input signals will be sent to the computer or iOS/iPadOS device using the balance settings made here. When using a Stereo Mix setting, the mixed stereo signal will be sent.

See "Adjusting input signal monitoring balance using fader and pan settings" (→ [page 39](#)) for how to mix inputs.

Managing SD cards

Checking SD card information

The open space and size of SD cards can be checked.

1. Tap **SD CARD** on the Home Screen.



2. Tap **Information**.

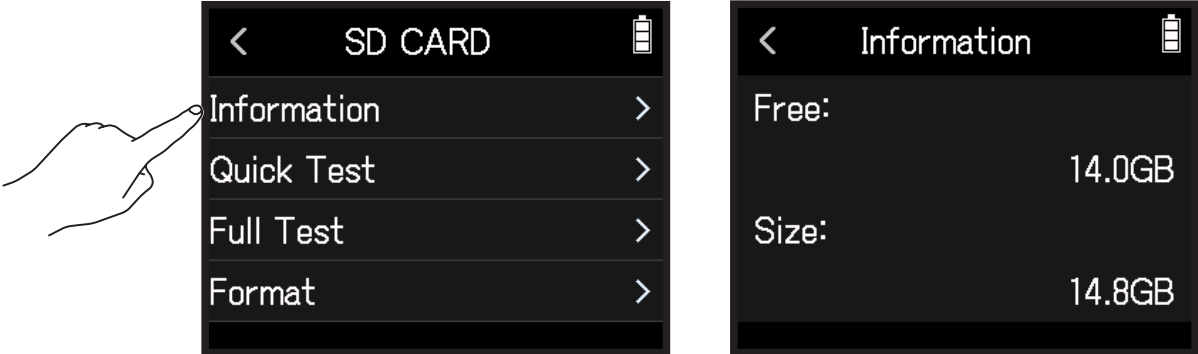

Testing SD card performance

Purchased SD cards can be tested to confirm that they can be used with the **H8**. A basic test can be done quickly, while a full test examines the entire SD card.

Conducting a quick test

1. Tap **SD CARD** on the Home Screen.



2. Tap **Quick Test**.

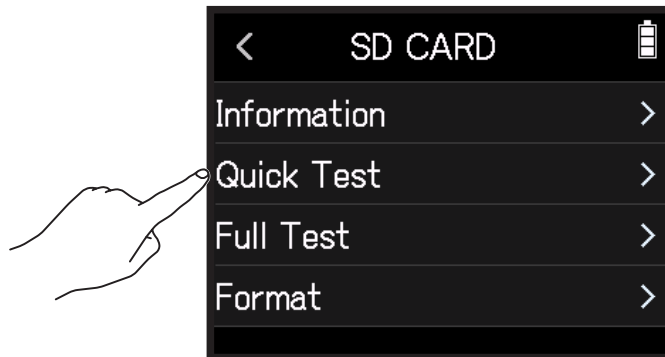

3. Select **Execute**.

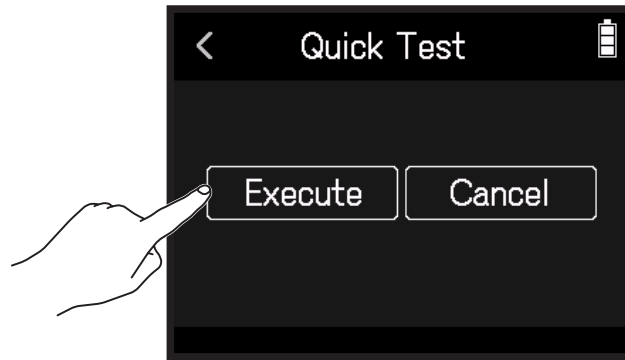

The card performance test will start and should take about 30 seconds. The result of the test will be shown when it completes.

HINT

Tap **<** to cancel the test.

Conducting a full test

1. Tap **SD CARD** on the Home Screen.



2. Tap **Full Test**.

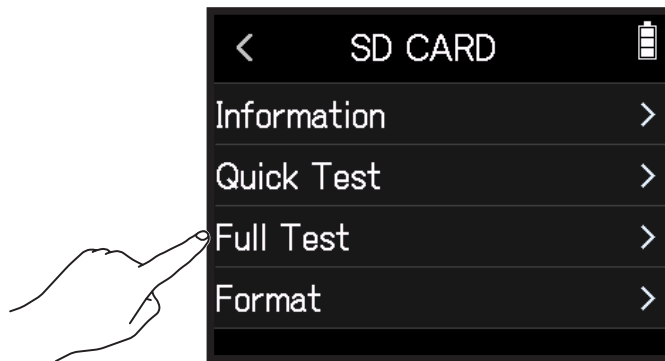

3. Select **Execute**.

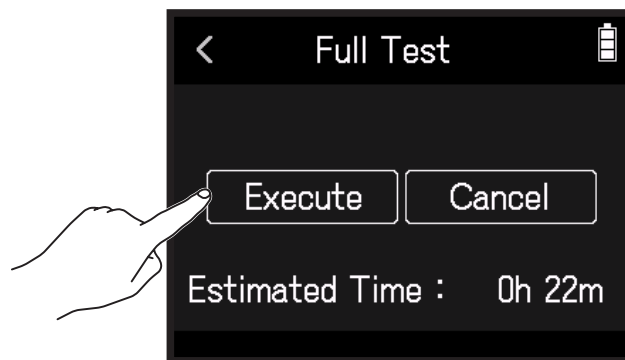

The card performance test will start. If the access rate MAX reaches 90%, the card will fail (NG).

HINT

Tap **<** to cancel the test.

NOTE

Even if a performance test result is "OK", there is no guarantee that writing errors will not occur. This information is just to provide guidance.

Formatting SD cards

1. Tap **SD CARD** on the Home Screen.



2. Tap **Format**.

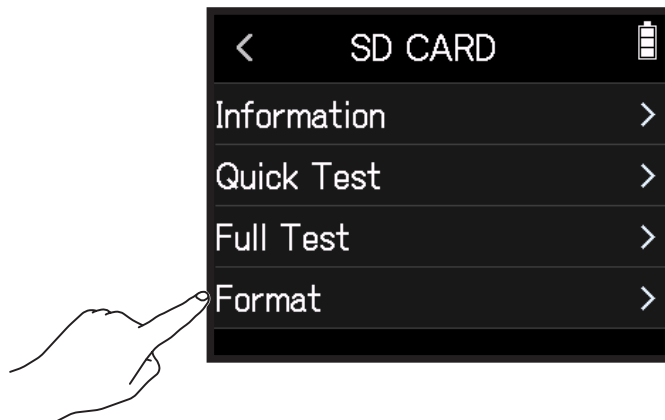

3. Select **Execute**.

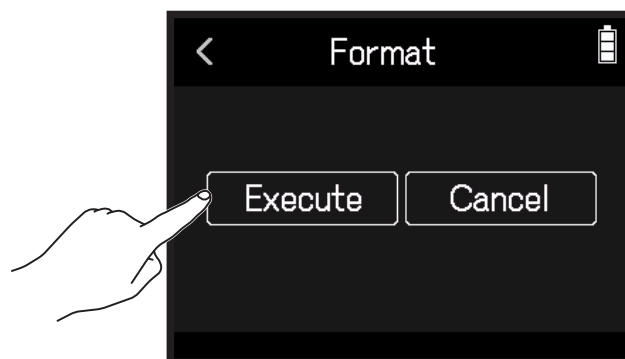

NOTE

- Before using SD cards that have just been purchased or that have been formatted on a computer, they must be formatted by the **H8**.
- All data previously saved on the SD card will be deleted when it is formatted. Please use caution.

Using as a card reader

When connected to a computer, data on the SD card can be checked and copied.

Connecting the H8 with a computer

1. Tap  SD CARD READER on the Home Screen.

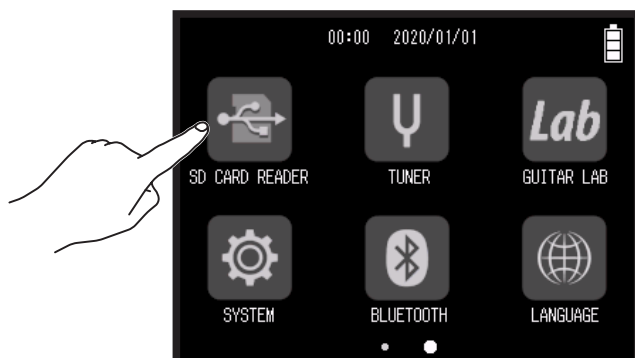

2. Use a USB cable to connect the **H8** and the computer.

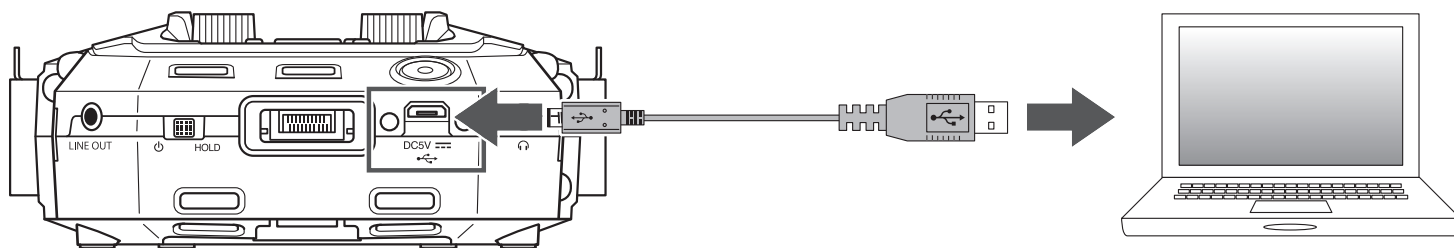

Disconnecting a computer from the H8

1. Conduct procedures on the computer to disconnect.
 - Windows: Select **H8** from "Safely Remove Hardware".
 - macOS: Drag the **H8** icon to the Trash and drop it.

NOTE

Always conduct computer ejection procedures before disconnecting the USB cable.

2. Disconnect the USB cable connecting the **H8** with the computer, and press .
3. Tap **Execute**.

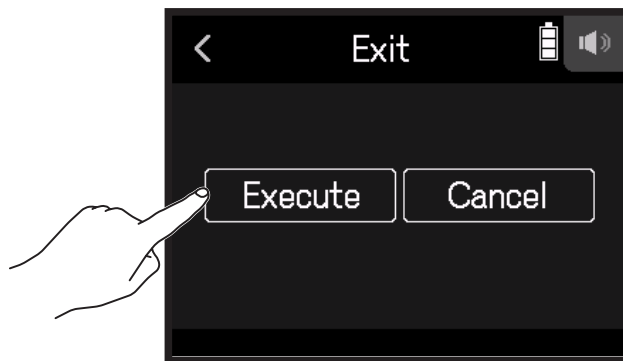

Using the tuner

Using the tuner function, you can tune guitars and other instruments.

Tuning guitars

1. Tap  TUNER on the Home Screen.

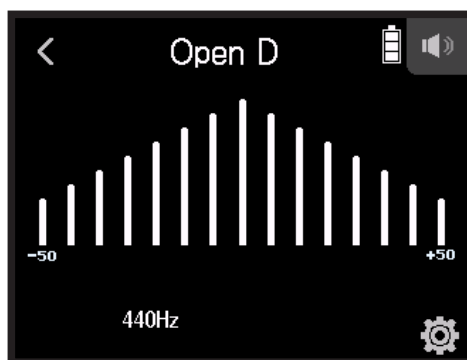
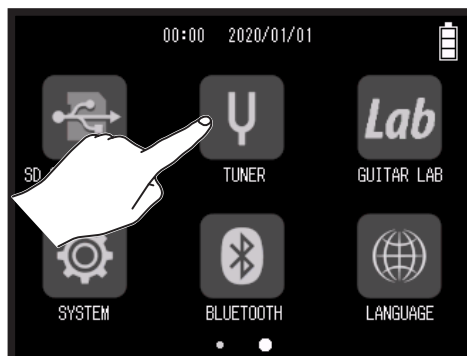

← Low pitch – Correct pitch – High pitch →

2. Play the open string that you want to tune and adjust its pitch.
The pitch detuning with the nearest note name or string number will be shown.

Changing the tuner type

1. Tap **TUNER** on the Home Screen.

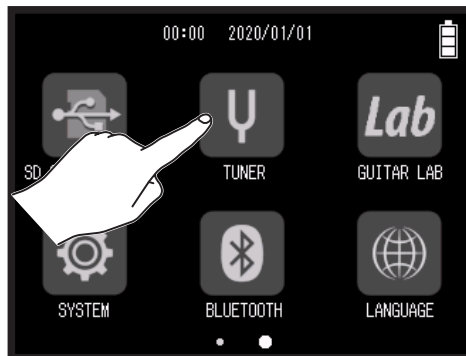

2. Tap .

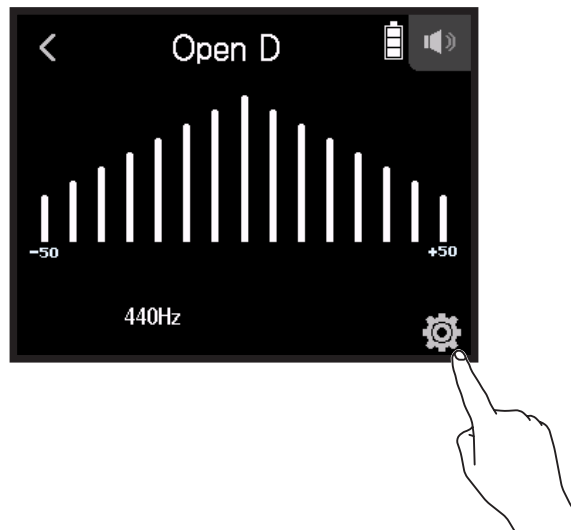

3. Tap **Type**.

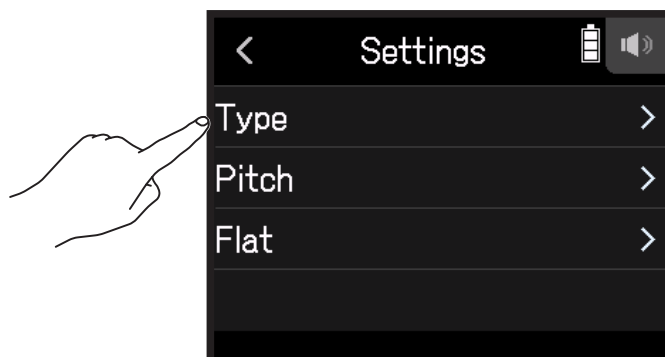

4. Tap the guitar type to select it.

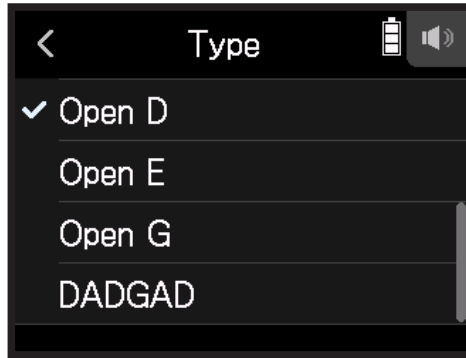

Available tuner type settings

Setting	Explanation	String number/note						
		7	6	5	4	3	2	1
Chromatic	The name of the nearest note (in semitones) and the amount of detuning are shown.	-	-	-	-	-	-	-
Guitar	Standard guitar tuning with a 7th string	B	E	A	D	G	B	E
Bass guitar	Standard bass guitar tuning with a 5th string.	-	-	B	E	A	D	G
Open A	Open A tuning (open strings play A chord)	-	E	A	E	A	C#	E
Open D	Open D tuning (open strings play D chord)	-	D	A	D	F#	A	D
Open E	Open E tuning (open strings play E chord)	-	E	B	E	G#	B	E
Open G	Open G tuning (open strings play G chord)	-	D	G	D	G	B	D
DADGAD	Alternate tuning often used for tapping and other techniques	-	D	A	D	G	A	D

Setting the standard pitch of the tuner

1. Tap  TUNER on the Home Screen.

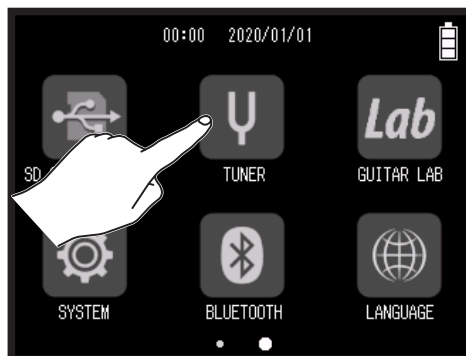

2. Tap .

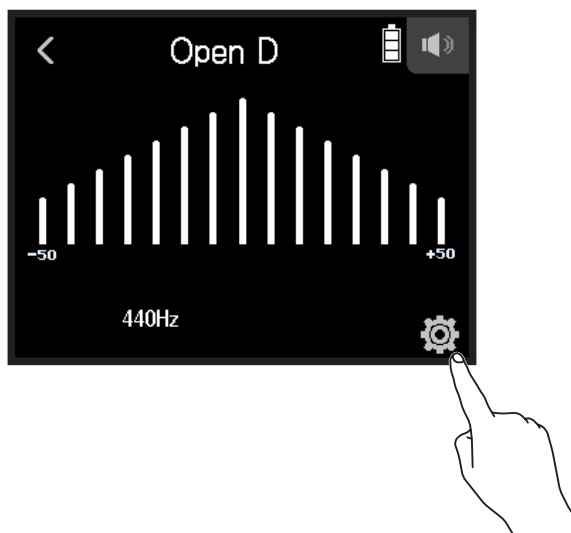

3. Tap Pitch.

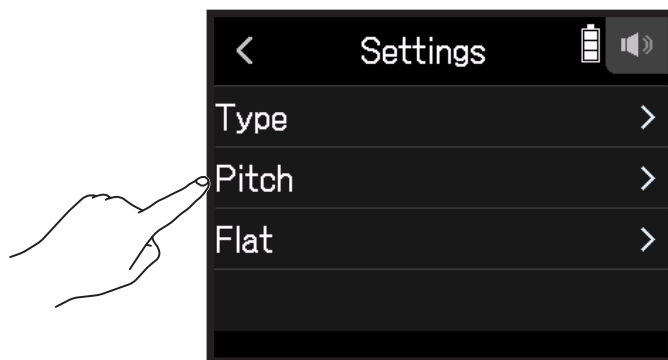

4. Slide  up and down to set the standard pitch, and tap.



HINT

This can be set from 435 Hz to 445 Hz.

Using flat tunings

All strings can be tuned down from standard tuning by 1–3 semitones.

1. Tap  TUNER on the Home Screen.

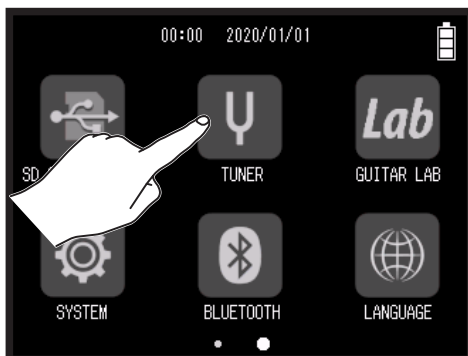

2. Tap .

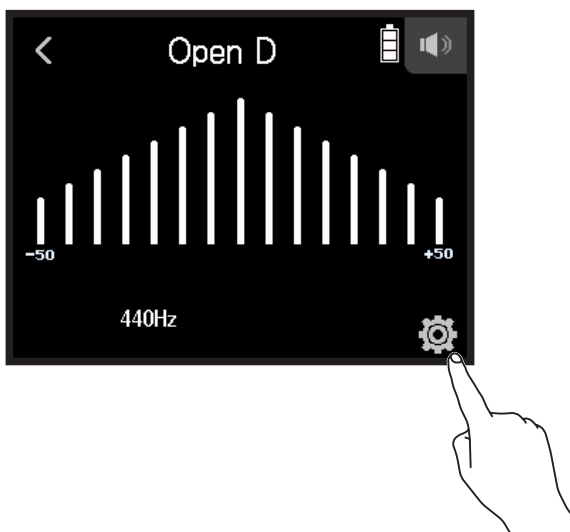

3. Tap Flat.

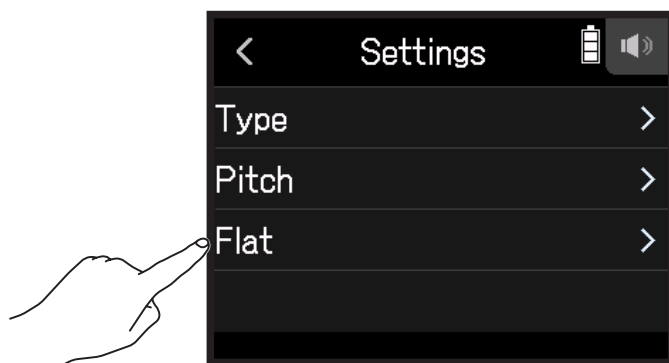

4. Tap a setting to select it.



HINT

This can be set from x0 to x3 (3 semitones lower).

NOTE

Flat tuning cannot be used when the tuner type is Chromatic.

Using Guitar Lab

Guitar Lab can be used on a computer (PC/Mac) to add effects that are distributed online as well as to edit and back up patch memories, for example.

Connecting Guitar Lab

1. Tap **Lab** GUITAR LAB on the Home Screen.

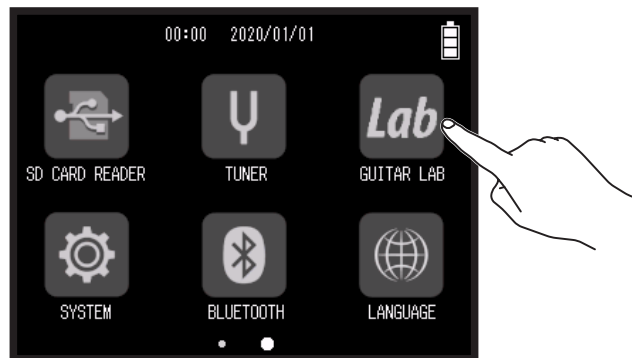

2. Use a USB cable to connect the **H8** and the computer.
3. Launch Guitar Lab on the Computer.

Disconnecting Guitar Lab

1. Press .
2. Tap **Execute**.

Setting the date and time

Setting the date and time

Set the date and time added to recording files.

1. Tap  SYSTEM on the Home Screen.

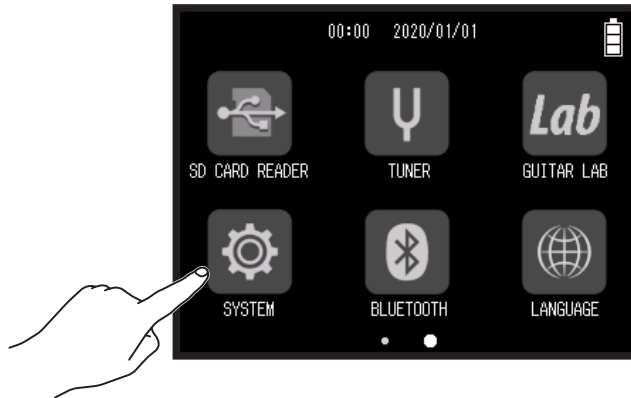

2. Tap Date/Time.

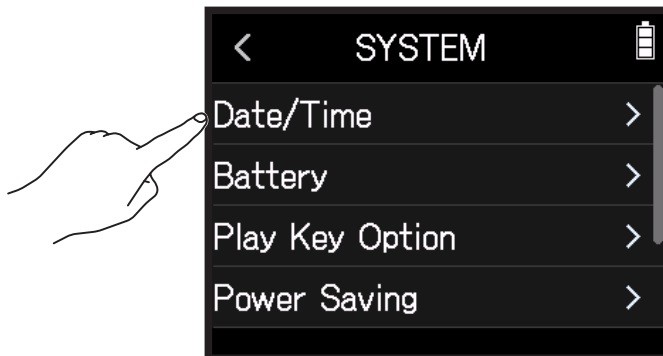

3. Tap Set Date/Time.

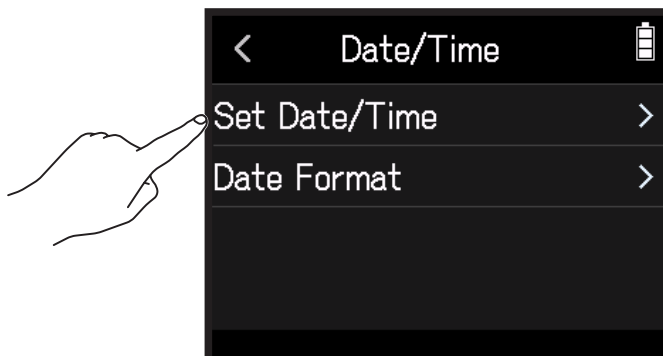

4. Swipe the date and time items to set them.

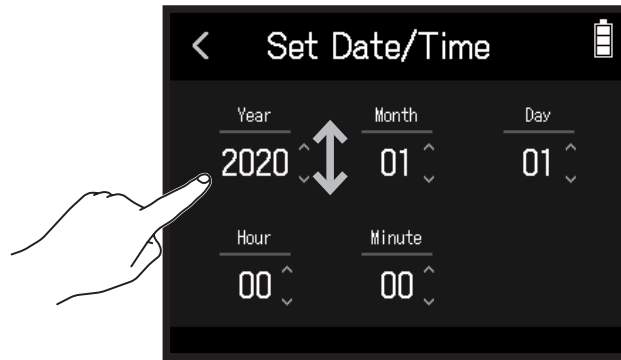

Setting the date format

1. Tap  SYSTEM on the Home Screen.

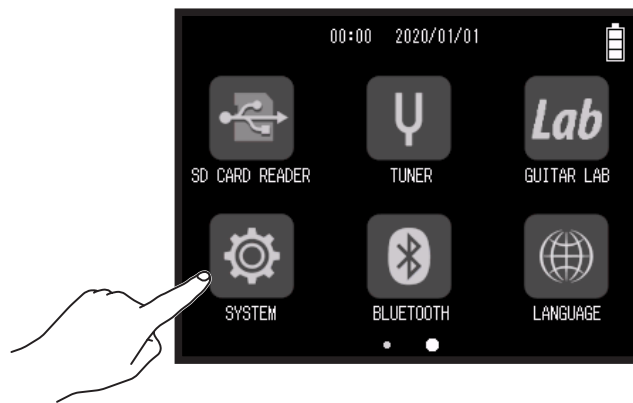

2. Tap **Date/Time**.

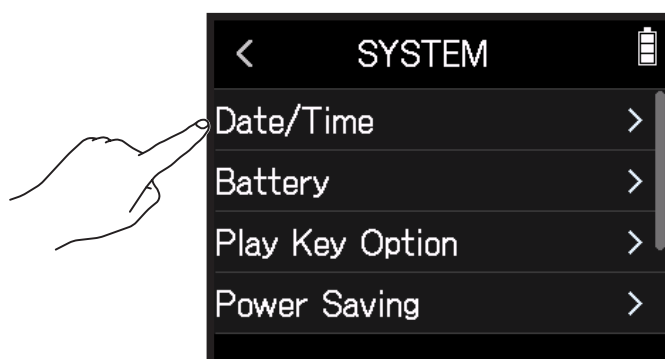

3. Tap **Date Format**.

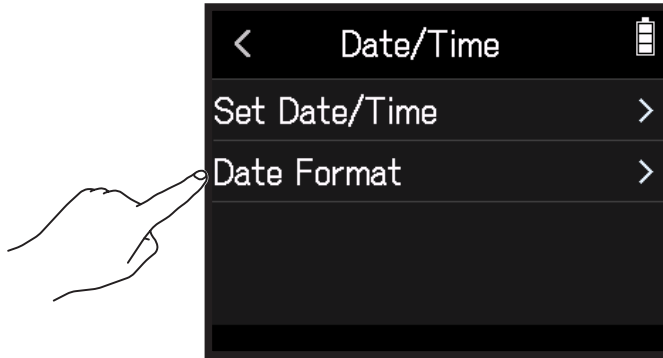

4. Tap the date format to select it.

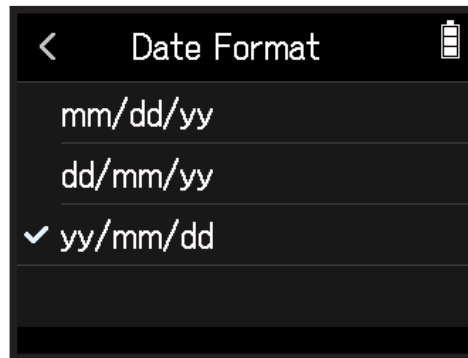

Setting the battery type

Set the type of battery used by the **H8** to alkaline, Ni-MH or lithium so that the amount of remaining battery charge can be accurately displayed.

1. Tap  **SYSTEM** on the Home Screen.

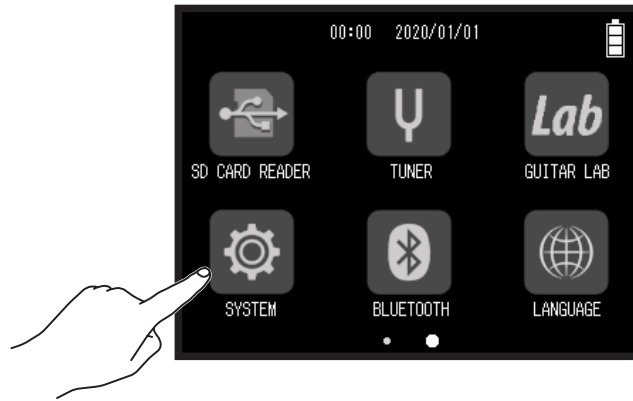

2. Tap **Battery**.

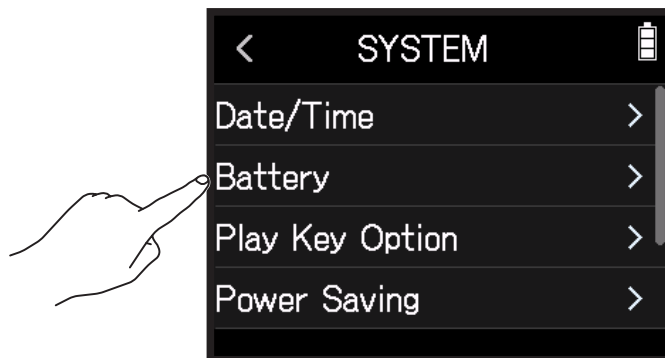

3. Tap a battery type to select it.

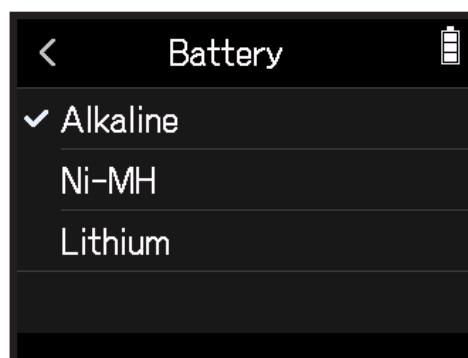

Setting how marks are added when recording/playing

You can set how marks are added when  is pressed while recording or playing back a WAV format file.

1. Tap  SYSTEM on the Home Screen.

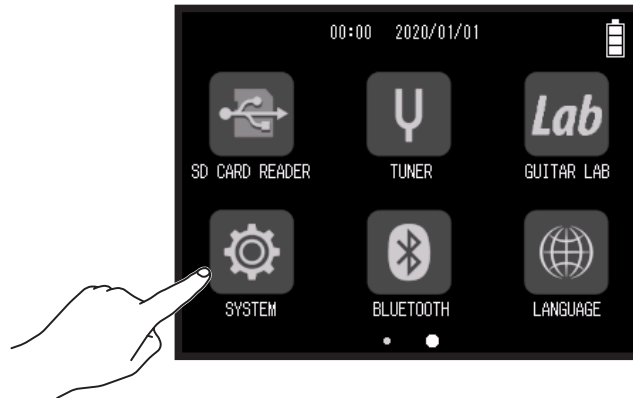

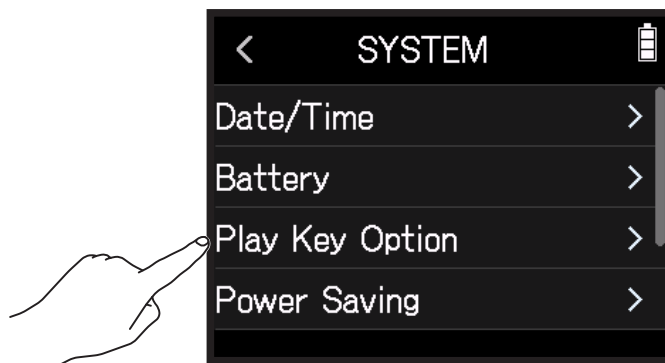

2. Tap Play Key Option.

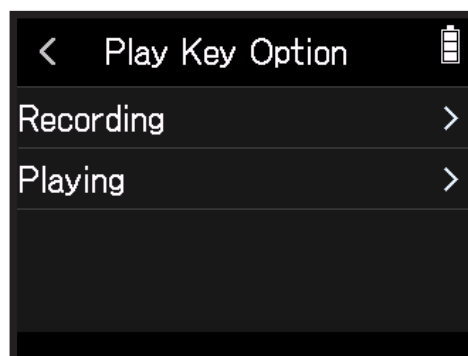

3. Tap Recording or Playing.



4. Tap a mark adding option to select it.

Mark adding method	Explanation
Pause	Pressing  will pause without adding a mark.
Pause & Mark	Pressing  will pause and add a mark.
Mark	Pressing  will add a mark without pausing.

Making display settings

Setting the display brightness

1. Tap  SYSTEM on the Home Screen.

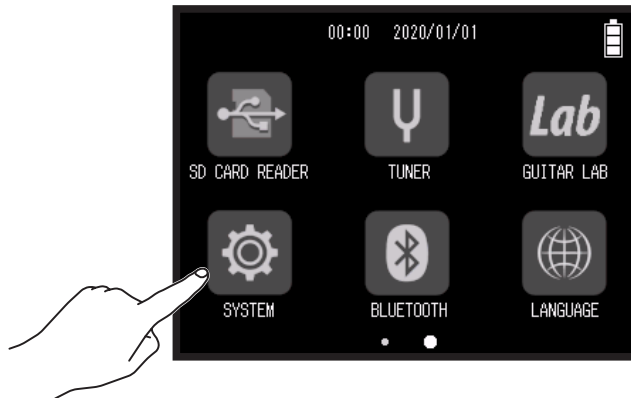

2. Tap Power Saving.

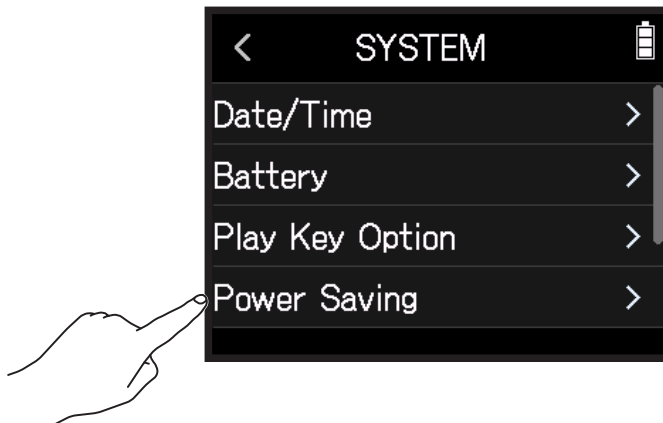

3. Tap LCD Brightness.

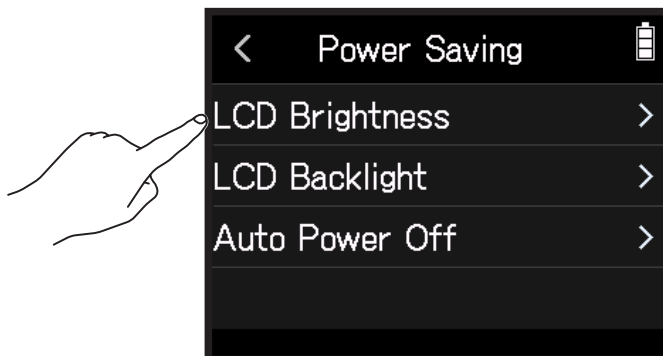

- Slide  up and down to adjust the brightness.



HINT

This can be set from 5 to 100.

Setting the display backlight

- Tap  **SYSTEM** on the Home Screen.

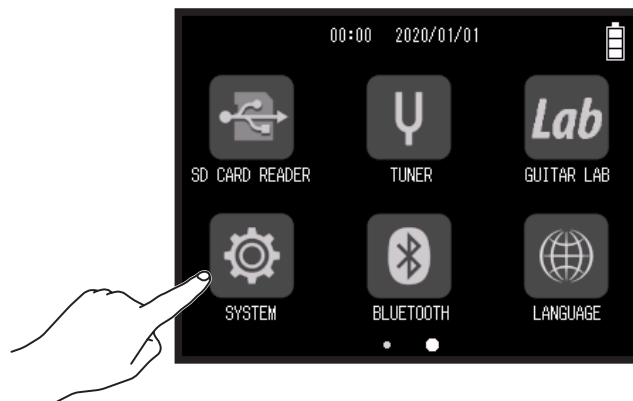

- Tap **Power Saving**.

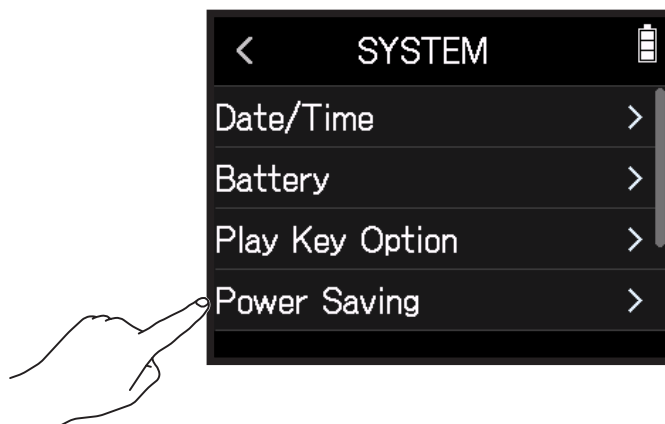

3. Tap LCD Backlight.

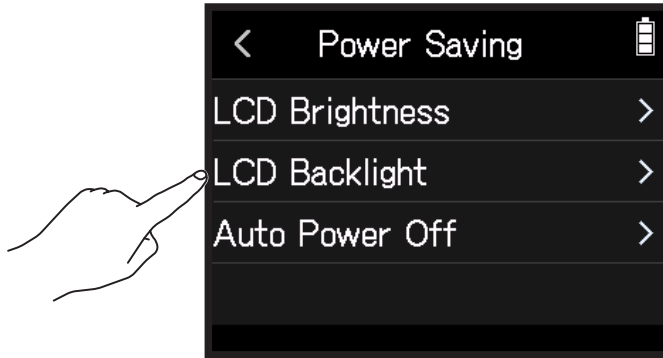

4. Tap a setting to select it.



Setting	Explanation
On	The backlight always stays bright.
30 seconds	The backlight will dim after the set time has elapsed.
1 min	
2 min	
3 min	
4 min	
5 min	

Setting the Auto Power OFF function

The power will automatically turn off if the **H8** is unused for 10 hours.

If you want the power to stay on continuously until powered off, disable the Automatic Power Saving function.

1. Tap  **SYSTEM** on the Home Screen.

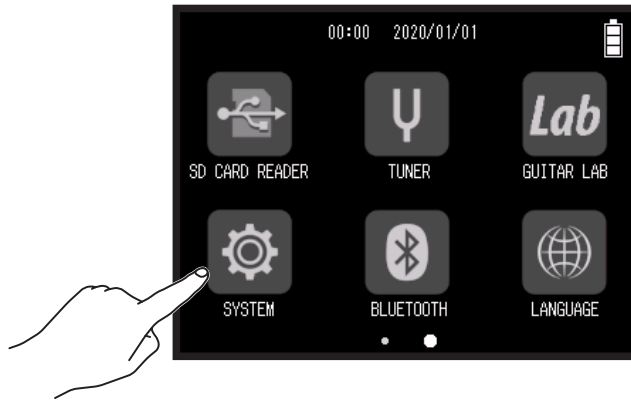

2. Tap **Power Saving**.

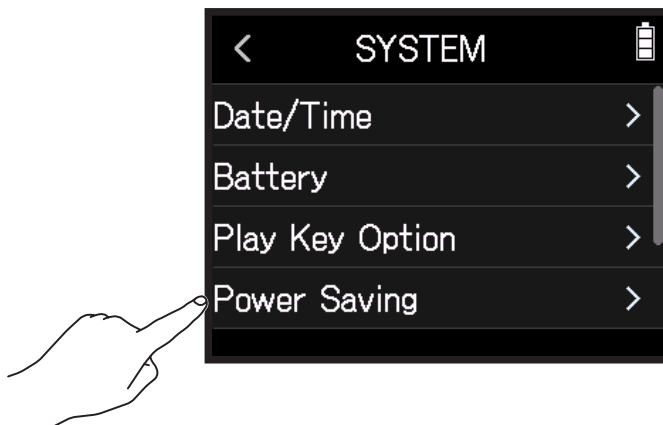

3. Tap **Auto Power Off**.

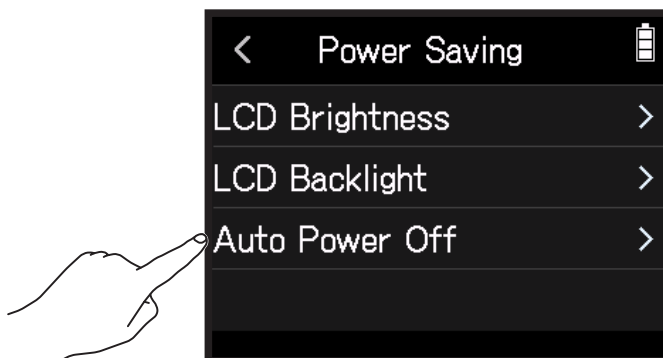

4. Set it to Off.

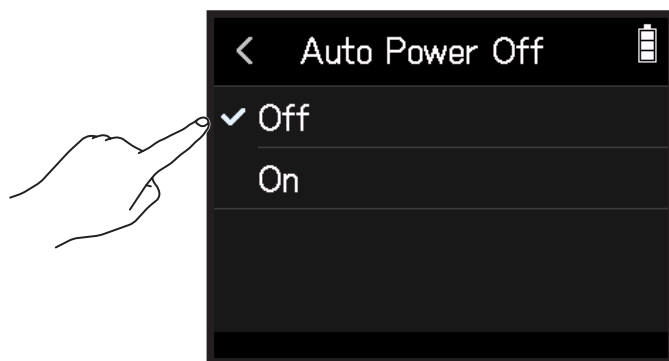

NOTE

This function is only enabled when power is being supplied through the USB port.

Operating from an iOS/iPadOS device

Connecting an iOS/iPadOS device

The **H8** can be operated from an iOS/iPadOS device by connecting a dedicated wireless adapter (e.g. BTA-1) and using the dedicated **H8** Control app.

NOTE

- The **H8** Control app must be installed on the iOS/iPadOS device beforehand. The **H8** Control app can be downloaded from the App Store.
- For app setting and operation procedures, see the manual for the **H8** Control app.

1. Remove the REMOTE connector cover and connect a BTA-1 or other dedicated wireless adapter.

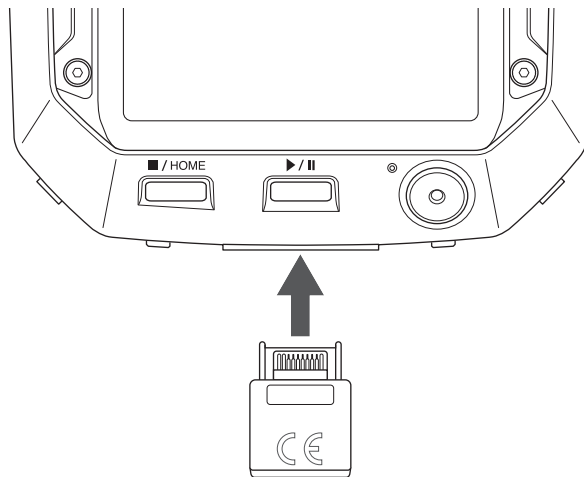

2. Tap  BLUETOOTH on the Home Screen.



3. Tap **Execute**.

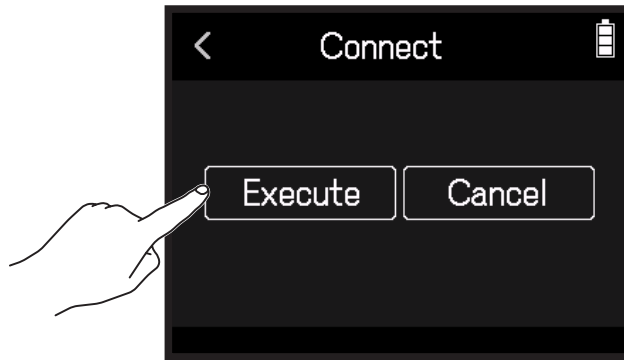

4. Launch the **H8** Control app on the iOS/iPadOS device, and conduct connection procedures.

HINT

For app setting and operation procedures, see the manual for the **H8** Control app.

Disconnecting from an iOS/iPadOS device

1. Tap  **BLUETOOTH** on the Home Screen.

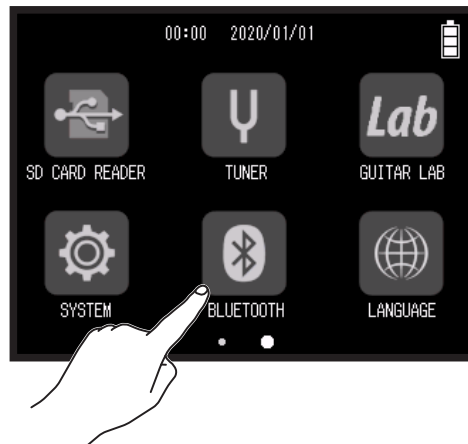

2. Tap **Execute**.

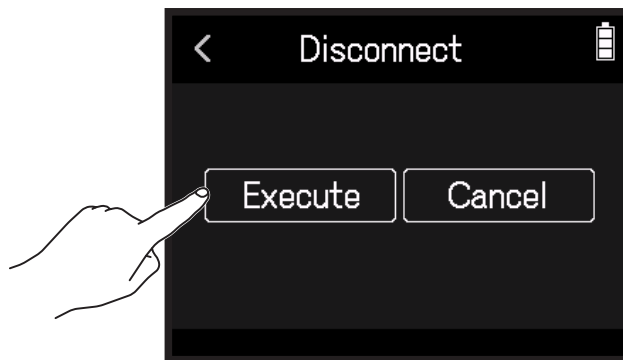

HINT

After disconnecting, tap **BLUETOOTH** on the Home Screen, and reconnect to the iOS/iPadOS device to use it again for operation.

Setting the language shown

1. Tap  LANGUAGE on the Home Screen.

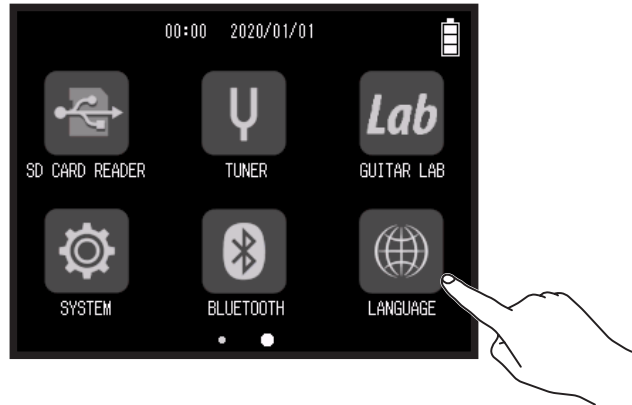

2. Tap a language to select it.

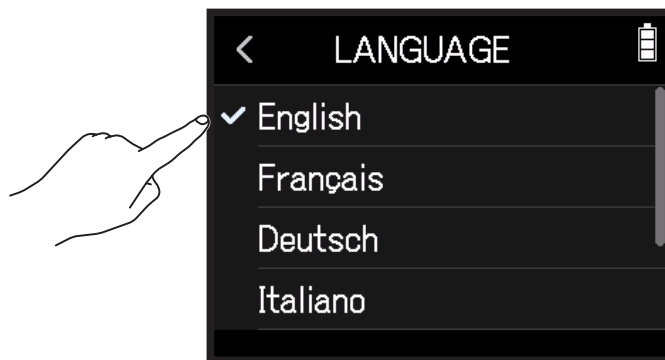

HINT

The first time the power is turned on after purchase, this screen opens automatically.

Restoring default setting values

The factory default settings can be restored.

1. Tap  **SYSTEM** on the Home Screen.

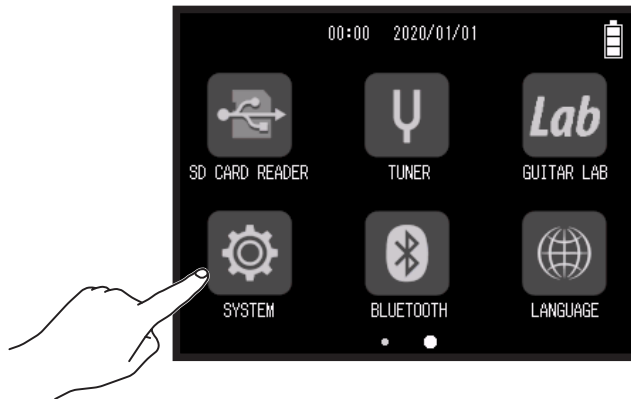

2. Tap **Factory Reset**.

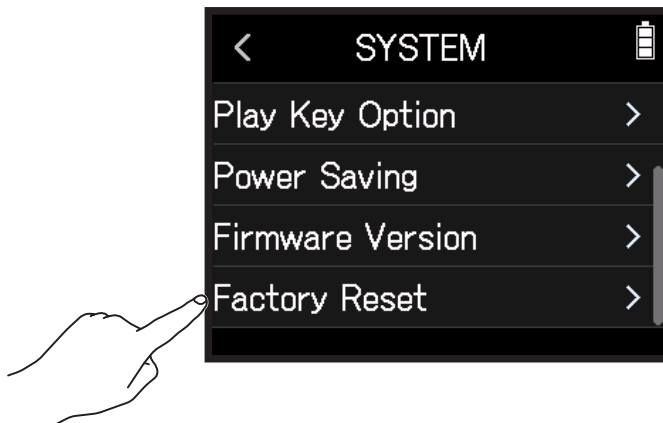

3. Tap **Execute**.

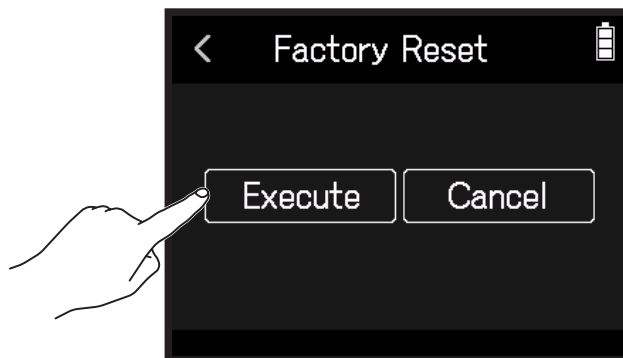

The settings will be reset and the power will automatically turn off.

Managing the firmware

Checking the firmware versions

1. Tap  SYSTEM on the Home Screen.

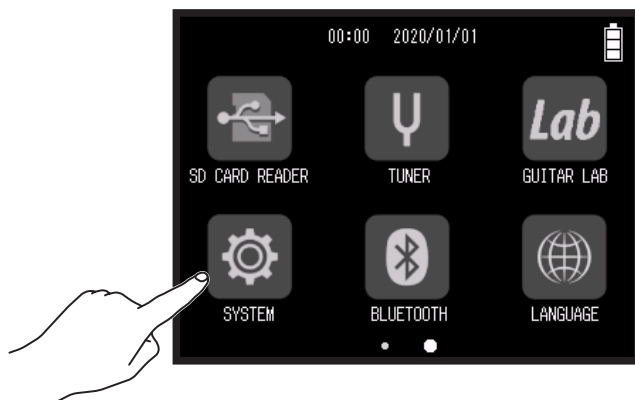

2. Tap Firmware Version.

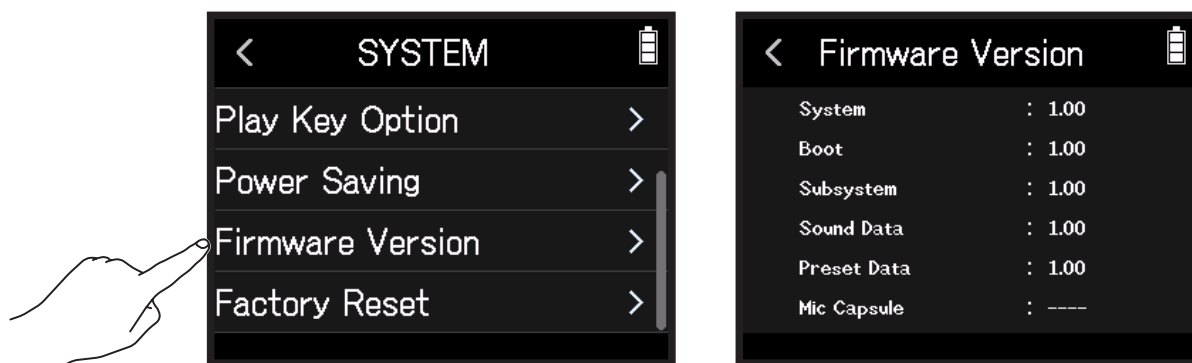

Updating the firmware

The **H8** firmware can be updated to the latest versions.

Files for the latest firmware updates can be downloaded from the ZOOM website (zoomcorp.com).

Follow the instructions in the “**H8** Firmware Update Guide” on the **H8** download page.

Using optional mic capsules

Using the XAH-8

Features and functions of parts

The XAH-8 is a mic capsule that enables convenient use of two different stereo formats (X-Y and A-B).

■ X-Y format

Record specific sound sources at near to medium distance with natural three-dimensional depth and width. This is optimal for recording solo performances, chamber music, live rehearsals, field recordings and similar situations.

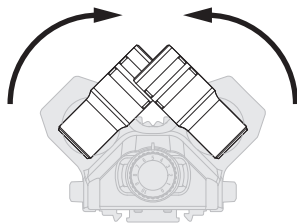
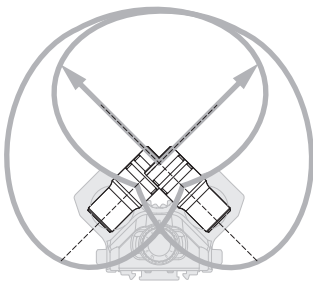

Turn the mics inward until they lock into place with a clicking sound.

■ A-B format

Record ambient sound along with specific sound sources for a wide stereo feel. This is optimal for recording the reverb of a hall, as well as for meetings and similar situations.

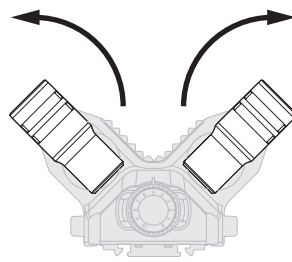
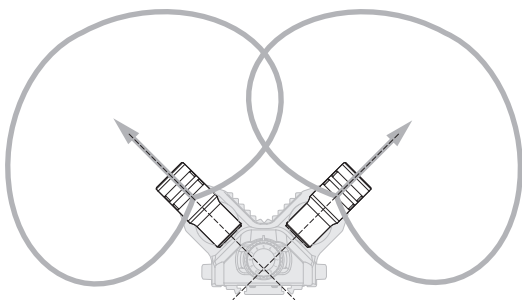

Turn the mics outward until they lock into place with a clicking sound.

■ Functions of parts

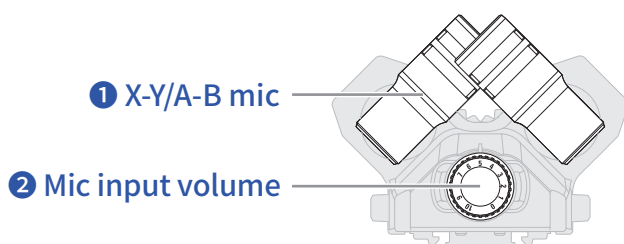

1 X-Y/A-B mic

This stereo mic can be used for X-Y or A-B recording.

The angle of audio capture can be changed by rotating the individual mics.

2 Mic input volume

This adjusts the mic input volume.

Appearance in each app

When the XAH-8 is attached, it appears in the apps as shown below.

FIELD app

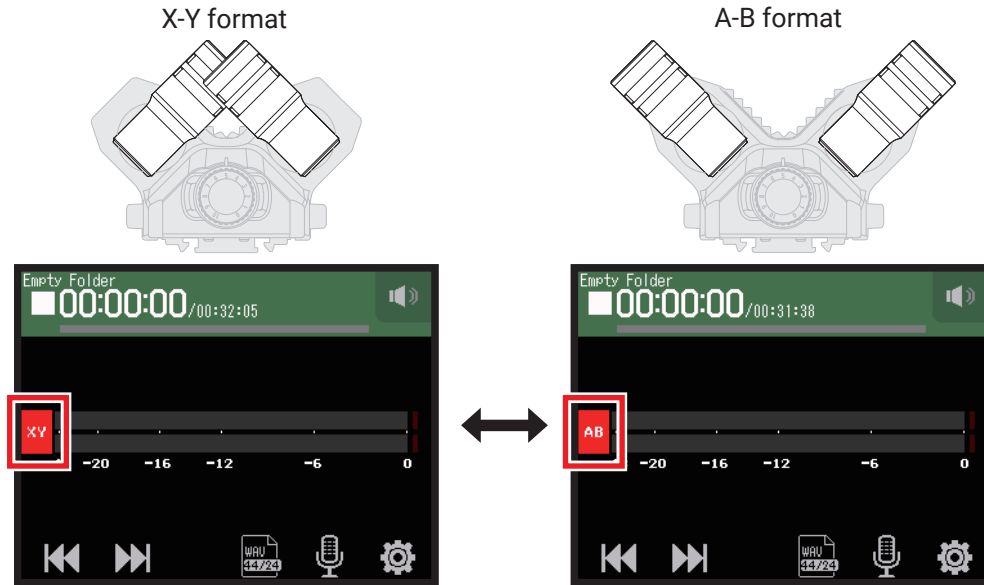

MUSIC app

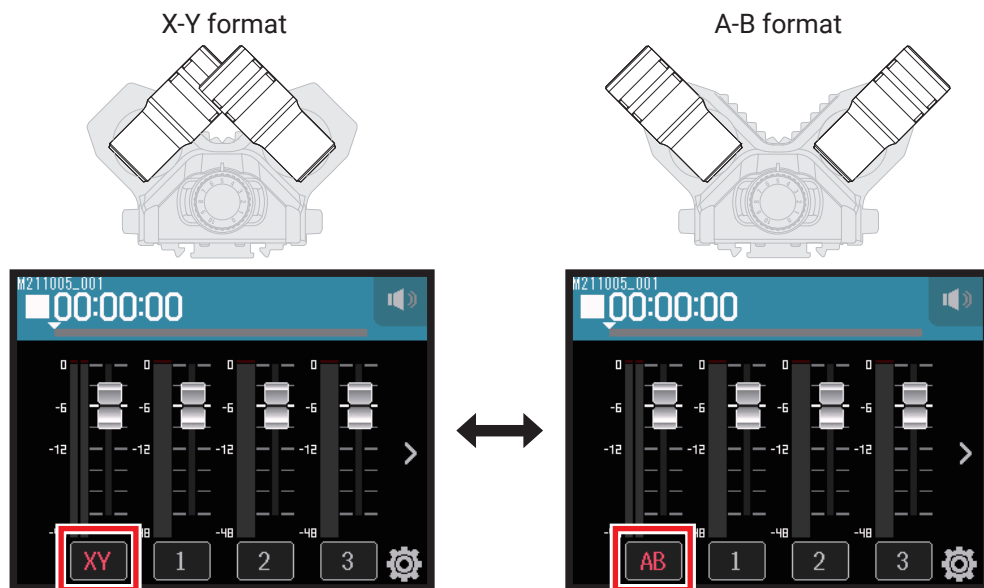



PODCAST app



The appearance does not change because of the mic capsule type.







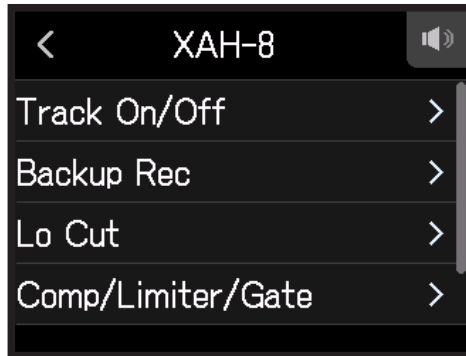









Making track settings

1. Open the Track Setting Screen in the app.
 - On the FIELD app screen, touch  and select XAH-8.
 - On the MUSIC app screen, select XY or AB and then .
 - On the PODCAST app screen, touch  and select XAH-8.

2. Tap each item to set it.



The following items can be set.

Item	Explanation/reference	Apps that use
Track On/Off	This turns track recording on/off. This can also be set with the mic track buttons on the unit. → “Enabling tracks for recording” on page 25	  
Backup Rec	→ “Backup recording (FIELD and PODCAST apps only)” on page 27	 
Lo Cut	→ “Reducing noise (low-frequency cut)” on page 33	  
Comp/Limiter/Gate	→ “Comp/Limiter/Gate” on page 34	  
Fader/Pan	→ “Adjusting input signal monitoring balance using fader and pan settings” on page 39	  
File Assign	→ “Changing files assigned to tracks” on page 74	
Effect	→ “Setting tracks to use effects from the PODCAST app screen” on page 97	

Using the EXH-8

Features and functions of parts

■ Features

- This capsule adds four channels of external XLR input.
- Signals can be input from dynamic/condenser mics, mixers and other equipment.
- Each input has a separate volume control, enabling quick and reliable level balancing at recording locations.
- -20dB pad switches enable professional equipment that uses +4dB line level to also be input without distortion.
- Phantom power can be supplied.

■ Connection example

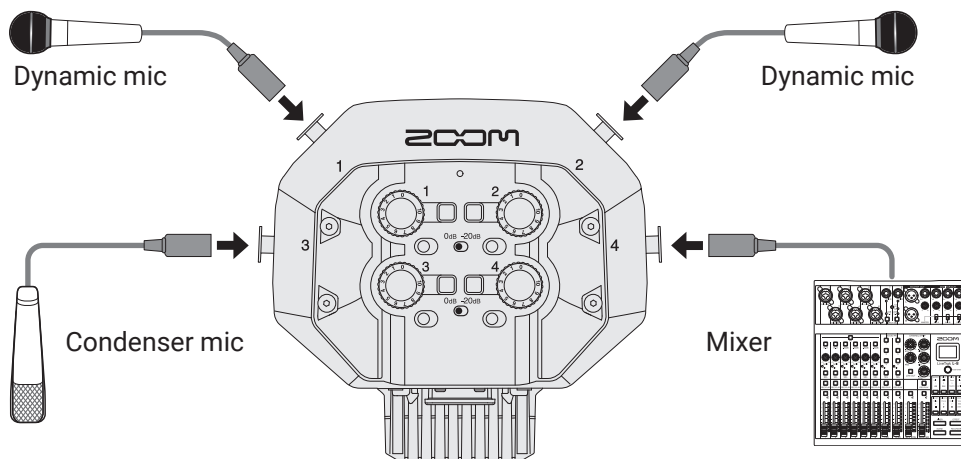

When connecting condenser mics and other devices that require phantom power, use an external power supply.

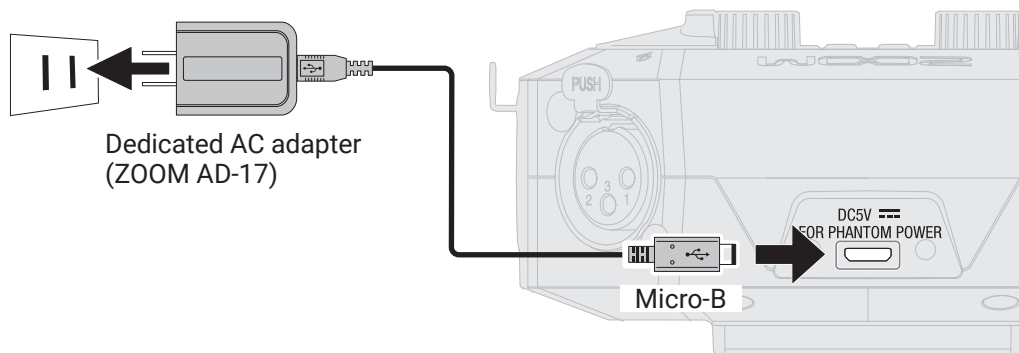

■ Functions of parts

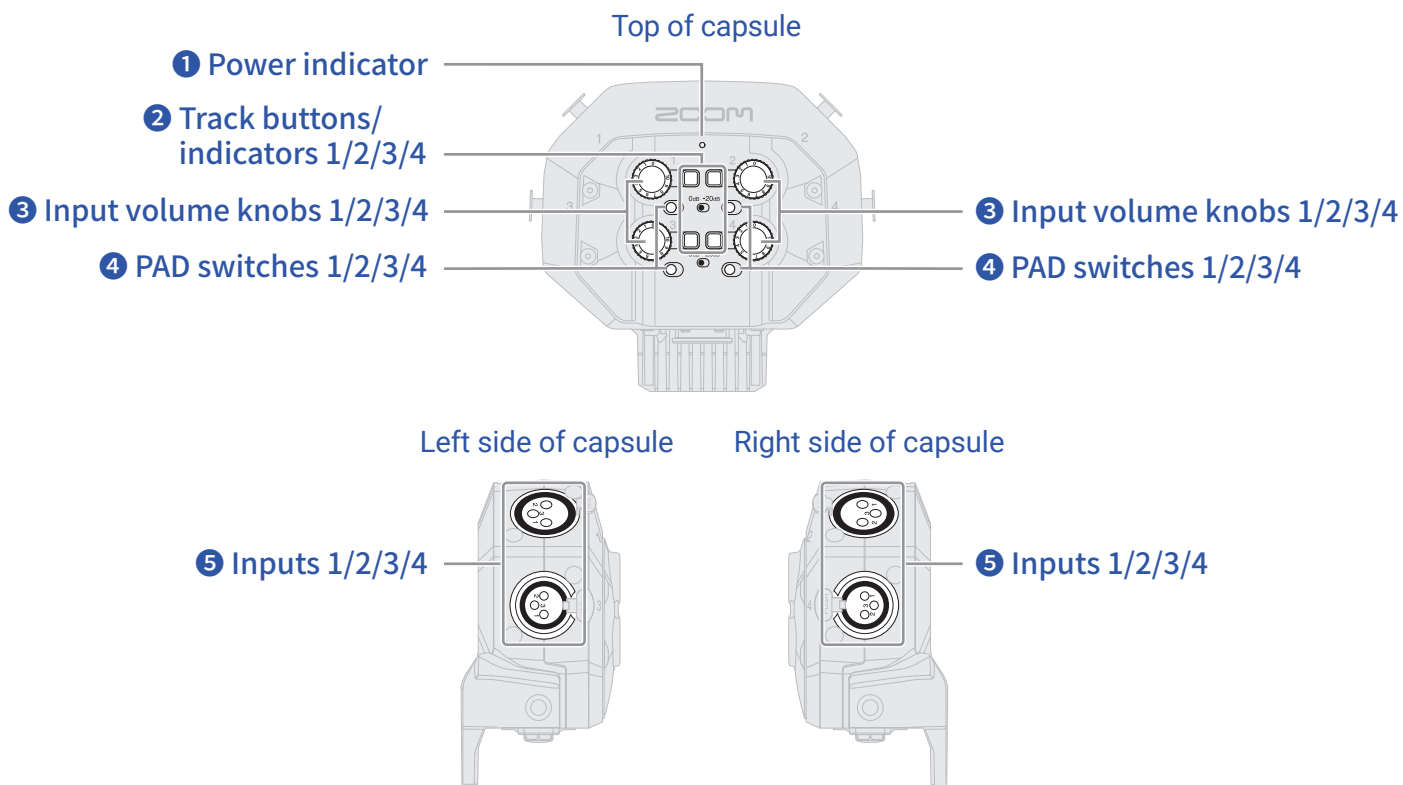

1 Power indicator

This will light when an external power supply is connected, showing that phantom power can be used.

2 Track buttons/indicators 1/2/3/4

These turn tracks on and off. Pressing track buttons will make their LEDs light red.

3 Input volume knobs 1/2/3/4

These adjust input volumes.

4 PAD switches 1/2/3/4

These attenuate the input signals of equipment connected to inputs 1–4 by 20 dB.

Set PAD switches to -20dB when connecting mixers, for example, that use $+4\text{ dBu}$ as the standard output level.

5 Inputs 1/2/3/4

Connect mics and mixers to these.

Appearance in each app

When the EXH-8 is attached, it appears in the apps as shown below.

FIELD app



MUSIC app

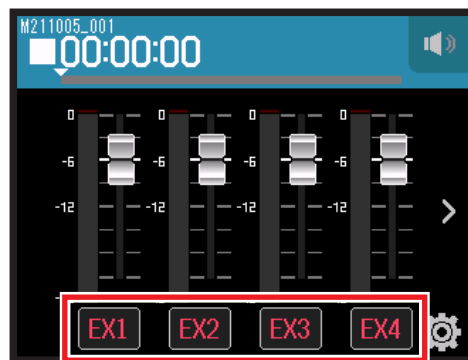



PODCAST app



The appearance does not change because of the mic capsule type.







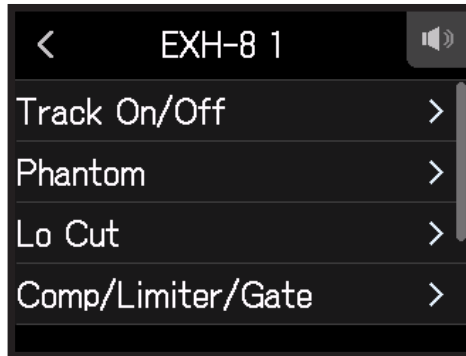













Making track settings

1. Open the Track Setting Screen in the app.
 - On the Field App Screen, touch  and select EXH-8 1–EXH-8 4.
 - On the MUSIC app screen, select EX1–EX4 and then .
 - On the PODCAST app screen, touch  and select EXH-8 1–EXH-8 4.

2. Tap each item to set it.



The following items can be set.

Item	Explanation/reference	Apps that use
Track On/Off	This turns track recording on/off. This can also be set with the mic track buttons on the unit. → “Enabling tracks for recording” on page 25	  
Phantom	→ “Setting phantom power” on page 30	  
Lo Cut	→ “Reducing noise (low-frequency cut)” on page 33	  
Comp/Limiter/Gate	→ “Comp/Limiter/Gate” on page 34	  
Fader/Pan	→ “Adjusting input signal monitoring balance using fader and pan settings” on page 39	  
Stereo Link	→ “Enabling stereo linking” on page 41	  
File Assign	→ “Changing files assigned to tracks” on page 74	
Effect	→ “Setting tracks to use effects from the PODCAST app screen” on page 97	

Using the VRH-8

Features and functions of parts

■ Features

The VRH-8 is an Ambisonic mic that uses 4 capsules to enable 360° recording and capture vertical spread and depth. The built-in position sensor enables recording with the correct mic position setting regardless of the mic orientation.

■ Recording modes

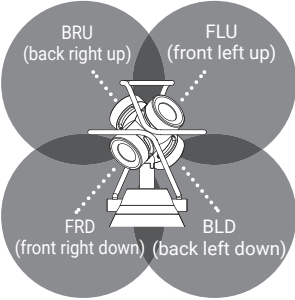
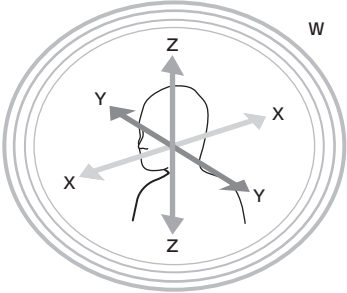
Ambisonics A	Ambisonics B
<p>Audio files are recorded as is for the four directional condenser mics.</p> 	<p>Data in A format is processed and distributed to four channels (W/X/Y/Z) to produce this audio data. FuMa and AmbiX are two modes that have different channel distribution methods.</p> 

■ Functions of parts

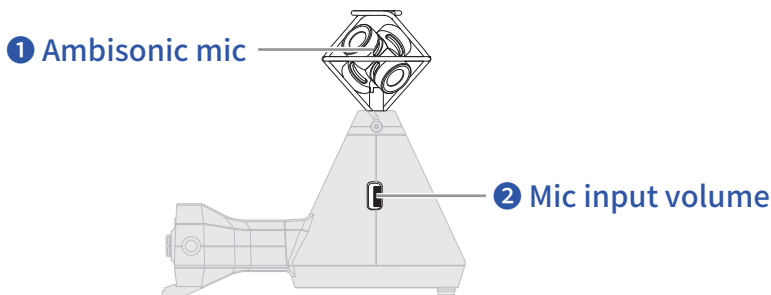

① Ambisonic mic

This Ambisonic mic is comprised of four unidirectional condenser mics. This mic can record three-dimensional sound with natural depth and width.

② Mic input volume

This adjusts the mic input volume.

Appearance in each app

When the VRH-8 is attached, it appears in the apps as shown below.

The orientation of the **H8** is detected by the position sensor and shown on the top screen of each app. Follow the instructions on the screen and adjust the angle of the **H8**.

FIELD app



MUSIC app

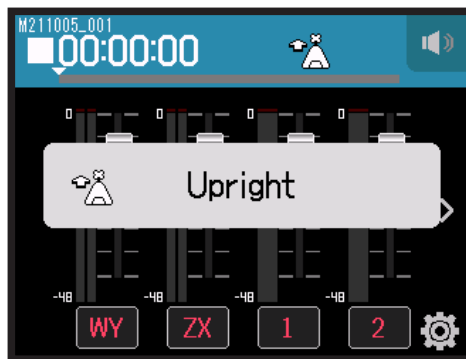



PODCAST app



The appearance does not change because of the mic capsule type.







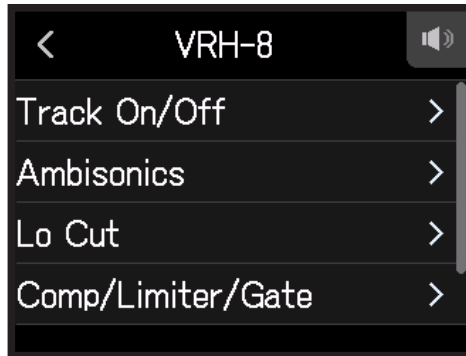









Making track settings

1. Open the Track Setting Screen in the app.
 - On the Field App Screen, touch  and select VRH-8.
 - On the MUSIC app screen, select WY or ZX and then .
 - On the PODCAST app screen, touch  and select VRH-8.

2. Tap each item to set it.





The following items can be set.

Item	Explanation/reference	Apps that use
Track On/Off	This turns track recording on/off. This can also be set with the mic track buttons on the unit. → “Enabling tracks for recording” on page 25	  
Ambisonics	→ “Making Ambisonics settings” on page 157	  
Lo Cut	→ “Reducing noise (low-frequency cut)” on page 33	  
Comp/Limiter/Gate	→ “Comp/Limiter/Gate” on page 34	  
Fader/Pan	→ “Adjusting input signal monitoring balance using fader and pan settings” on page 39	  
File	→ “Changing files assigned to tracks” on page 74	

NOTE

Effects and the Pan of Fader/Pan cannot be used.

Making Ambisonics settings

1. Open the Track Setting Screen in the app.
 - On the FIELD app screen, touch . Then select VRH-8 and Ambisonics.
 - On the MUSIC app screen, select WY or ZX. Then select  and Ambisonics.
 - On the PODCAST app screen, touch . Then select VRH-8 and Ambisonics.
2. Tap each item to set it.

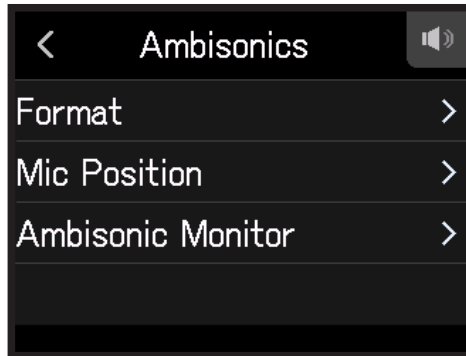

Format

This sets the file format used to record files.



Setting	Explanation
FuMa	Record as Ambisonic B FuMa format (4-channel).
AmbiX	Record as Ambisonic B AmbiX format (4-channel).
Ambisonics A	Record as Ambisonic A format (4-channel).
Stereo	Record as an ordinary stereo (2-channel) file.
Binaural	Record as a stereo (2-channel) file that has been converted to binaural.

NOTE

Binaural cannot be used when the recording format is 96k/16bit or 96k/24bit.

■ Mic position

Set the mic position used for recording. Whichever mic position is selected will record as though facing front.

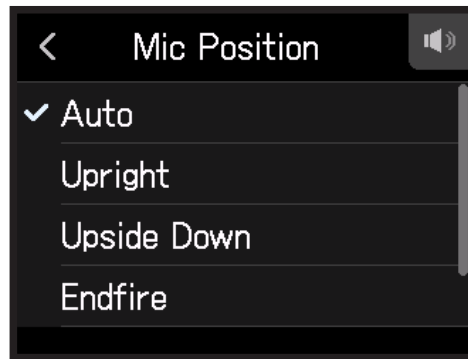

Setting	Explanation
Automatic	When recording starts, the mic position will automatically be set to one of the four below.
Upright	
Upside Down	
Endfire	
Endfire Invert	

NOTE

- If the Mic Position setting and the mic orientation during recording are not the same, recording files cannot be made with the correct orientation and the front orientation will be off during playback.
- When the Mic Position setting is Auto, an animation will guide orientation of the mic so that it matches the closest of the other four mic position settings.
- The Mic Position setting becomes fixed when recording starts. The Mic Position setting will not change during recording even if the mic orientation is changed.

HINT

To minimize reflections, we recommend placing the VRH-8 as far from walls and the floor as possible when recording.

Ambisonic Monitor

This sets the conversion format when outputting input signals from the PHONE OUT and LINE OUT jacks.



Setting	Explanation
Stereo	The input sound is converted to ordinary stereo for monitoring.
Binaural	The input sound is converted to binaural for monitoring.

NOTE

Binaural cannot be used when the recording format is 96k/16bit or 96k/24bit.

Appendix

Troubleshooting

If you think that the **H8** is operating strangely, check the following items first.

Recording/playback trouble

■ There is no sound or output is very quiet

- Check the connections to the monitoring system and its volume setting.
- Confirm that the **H8** volume is not too low. (→ [“Setting the headphone output level” on page 42](#))

■ Sound from connected equipment or inputs cannot be heard or is very quiet

- If you are using a mic capsule, confirm that it is oriented correctly.
- Check the input level setting. (→ [“Setting recording \(input\) levels” on page 26](#))
- If a CD player or other device is connected to an input jack, raise the output level of that device.
- Check the input signal monitoring settings. (→ [“Adjusting input signal monitoring balance using fader and pan settings” on page 39](#))
- Check the phantom power and plug-in power settings. (→ [“Setting phantom power” on page 30](#), [“Using plug-in power” on page 28](#))

■ Recording is not possible

- Confirm that the track button indicators are lit red.
- Confirm that the SD card has open space. (→ [“Checking SD card information” on page 117](#))
- Confirm that an SD card is loaded properly in a card slot.
- If “Card Protected!” appears on the display, the SD card write-protection is enabled. Slide the lock switch on the SD card to disable write-protection.

■ Recorded sound cannot be heard or is very quiet

- Confirm that the volume levels of the tracks are not too low. (→ [“Setting recording \(input\) levels” on page 26](#))
- Confirm that the track button indicators are lit green during playback.

Other trouble

■ Computer does not recognize it even though it is connected to a USB port

- Confirm that the operating system is compatible. (→ zoomcorp.com)
- The operation mode must be set on the **H8** to allow the computer to recognize the **H8**. (→ [“Using as an audio interface” on page 112](#), [“Using as a card reader” on page 122](#))

■ Battery operation time is short

Making the following settings could increase the battery operation time.

- Set the correct type of batteries being used. (→ [“Setting the battery type” on page 134](#))
- Turn unnecessary tracks off. (→ [“Enabling tracks for recording” on page 25](#))
- Set the phantom power voltage to 24 V. (→ [“Setting phantom power voltage” on page 32](#))
- Reduce the display brightness. (→ [“Setting the display brightness” on page 136](#))
- Set the display to dim when not used for some time. (→ [“Setting the display backlight” on page 137](#))
- Reduce the sampling rate used to record files. (→ [page 47](#), [“Setting the recording format” on page 91](#))
- Due to their characteristics, using nickel metal hydride batteries (especially high-capacity ones) or lithium batteries should enable longer use than alkaline batteries when power consumption is high.

Specifications

Recording media	Cards that support SD/SDHC/SDXC specifications			
XY mic (XYH-6)	Mic type	Directional		
	Sensitivity	-41 dB, 1 kHz at 1 Pa		
	Input gain	-∞ to 46.5 dB		
	Maximum sound pressure input	136 dB SPL		
	MIC/LINE IN stereo mini jack	Input gain: -∞ to 46.5 dB Input impedance: 2 kΩ Plug-in power: 2.5 V supported		
Inputs	MIC IN	Backup input	Set input gain -12 dB	
		INPUTS 1 – 4	Connectors	XLR jack (pin 2 hot)
	Input gain		-30 – 55.5 dB (-20 dB with PAD)	
	Input impedance		2 kΩ or more	
	Maximum allowable input level		+24.0 dBu (PAD ON)	
	Phantom power		+24 V/+48 V (independent ON/OFF for INPUTS 1–4)	
	Equivalent input noise (EIN)		-123.5 dBu or less (A-wt)	
	INPUTS A, B		Connectors	XLR/TRS combo jacks (XLR: 2 hot, TRS: TIP hot)
		Input gain	-30 to 55.5 dB	
		Input impedance	7 kΩ or higher (Hi-Z (TS) is 300 kΩ or higher)	
		Maximum allowable input level	+4.0 dBu (Hi-Z (TS) is -2.0 dB)	
		Phantom power	+24 V/+48 V (independent ON/OFF for INPUTS A and B)	
		Equivalent input noise (EIN)	-123.5 dBu or less (A-wt)	
	Outputs	Output jack	LINE OUT (stereo mini jack)	Rated output level: -10 dBu when output load impedance is 10 kΩ or more
			PHONE OUT (stereo mini jack)	Maximum output level: 20 mW + 20 mW into 32 Ω load
Built-in speaker		400 mW/8 Ω mono speaker		
Recording formats		FIELD	WAV setting	
	Supported formats		44.1/48/96 kHz, 16/24-bit, mono/stereo, BWF format	
	Maximum simultaneous recording tracks		12 tracks (MIC IN, backup recording, 1-4, A, B, and LR)	
	MP3 setting			
	Supported formats		128, 192, 320 kbps	
	Maximum simultaneous recording tracks		2 tracks	
	MUSIC	WAV setting		
		Supported formats	44.1/48 kHz, 16/24-bit, mono/stereo, BWF format	
		Maximum simultaneous recording tracks	8 tracks (MIC IN, 1-4, A, B)	
	PODCAST	WAV setting		
		Supported formats	44.1/48 kHz, 16/24-bit, mono/stereo, BWF format	
		Maximum simultaneous recording tracks	10 tracks (MIC IN, backup recording, 1, 2, A, B, and LR)	
MP3 setting				
Supported formats		128, 192, 320 kbps		
Maximum simultaneous recording tracks		2 tracks		
Recording time	With 32GB card 50:08:00 (44.1 kHz/16-bit WAV) 555:28:00 (128 kbps MP3)			

Tuner	Chromatic/Guitar/Bass/Open A/Open D/Open E/Open G/DADGAD
Display	2.4" (320×240) full-color touchscreen LCD
USB	<p>USB Micro-B</p> <p>Mass storage class operation USB2.0 High Speed</p> <p>Guitar Lab connection function USB1.1 Full Speed</p> <p>Audio interface operation: multi track mode (Note: Use with Windows requires a driver, but Macintosh does not) USB2.0 High Speed 12in/2out, 44.1/48/96 kHz, 16/24-bit</p> <p>Audio interface operation: stereo mode USB2.0 Full Speed 2in/2out, 44.1/48 kHz, 24-bit</p> <p>Note: Use as an iPad audio interface supported (stereo mode only) Note: Use a USB cable that supports data transfer. USB bus power is supported.</p>
REMOTE	ZOOM BTA-1 or other dedicated wireless adapter
Estimated continuous operation time using batteries (hours: minutes)	<p>Using alkaline batteries Using XY mic, 44.1 kHz/24-bit (stereo × 1): about 10:00</p> <ul style="list-style-type: none"> • The above values are approximate. • Continuous battery operation times were determined using in-house testing methods. They will vary greatly according to use conditions.
Power	<ul style="list-style-type: none"> • 4 AA batteries (alkaline, NiMH or lithium) • AC adapter (ZOOM AD-17): DC 5 V/1 A • USB bus power
External dimensions	<p>H8: 116.4 mm (W) × 163.3 mm (D) × 48.6 mm (H) XYH-6: 78.9 mm (W) × 60.2 mm (D) × 45.2 mm (H)</p>
Weight	<p>H8: 354 g XYH-6: 130 g</p>



ZOOM CORPORATION

4-4-3 Kanda-surugadai, Chiyoda-ku, Tokyo 101-0062 Japan
zoomcorp.com