

Godox 神牛

WITSTRO⁺ 威客
一体式外拍闪光灯
All-in-One Outdoor Flash

AD400^{Pro}



深圳市神牛摄影器材有限公司

GODOX Photo Equipment Co., Ltd.

地址/Add: 深圳市宝安区福海街道塘尾社区耀川工业区厂房2栋1层至4层、4栋1层至4层
1st to 4th Floor, Building 2/ 1st to 4th Floor, Building 4, Yaochuan Industrial Zone,
Tangwei Community, Fuhai Street, Bao'an District, Shenzhen 518103, China

电话/Tel: +86-755-29609320(8062)

传真/Fax: +86-755-25723423

邮箱/E-mail: godox@godox.com

<http://www.godox.com>

705-AD600P-06

Made In China



中英文双语 / Chinese English Bilingual

说明手册 / INSTRUCTION MANUAL

前言

请先仔细阅读本手册,以确保您能安全使用。

请保存好本手册以备将来查询参考。

感谢您购买神牛产品。

威客AD400Pro一体式外拍闪光灯是一款无线TTL大功率闪光灯,锂电池与机身一体式,携带方便;采用内置神牛2.4G无线X系统,配合Xpro、X1系列触发器可远程控制TTL/M/Multi模式触发AD400Pro闪光;同时,它还可以跟神牛TTL机顶灯、TTL外拍灯、TTL影室灯利用TTL主从属功能组合使用。使用AD400Pro闪光灯,您将获得更简单的拍摄体验,在光线变化复杂的情况下,可以自动获得准确的闪光曝光,拍摄轻松自如。

威客AD400Pro闪光灯,功率强劲,电池容量大,支持全程高速,单支可压太阳光,外露灯管和反光罩为户外拍摄和实景拍摄提供了良好的光质。AD400Pro是离机闪光中的绝对主力,便携与高效光质兼具,实为自由商业摄影师、新闻记者、发烧友、摄影爱好者、婚纱摄影纪实摄影师等的理想光源。

产品有以下亮点:

- **极速回电:** 0.01-1s。
- **色温恒定:** 全程档位波动 $\pm 75K$ 范围内(色温恒定模式)。
- **LED造型灯:** 30W 大功率LED造型灯,亮度自由调节。
- **调光精准:** 功率调节范围大(1/1-1/256),25级精确微调,光效把握更随心。
- **高级功能:** 支持1/8000秒高速同步,高速频闪,高速遥控器同步触发等。
- **无线TTL系统全面兼容:** 支持佳能、尼康、索尼、富士、奥林巴斯、松下等TTL自动闪光系统。
- **无线操控:** 内置使用神牛2.4G无线X系统;无线控制闪光灯功率大小,并同步触发引闪;同时留有3.5mm同步插孔,可实现多种同步触发方式。
- **点阵液晶屏:** 显示直观,操作更加简易。
- **影棚光质:** 功率高达400Ws,闪光指数GN72(m ISO 100,使用高效反光罩)
- **附件齐全:** 机身为新神牛卡口,标配保莱口适配卡盘,且能兼容布朗、保富图、爱玲珑等附件(另购卡口)。



警告

- ▲ 请保持干燥。
- ▲ 请勿私自拆卸产品,如产品出现故障须由本公司或授权的维修人员进行检查维修。
- ▲ 请勿让儿童接触本产品。
- ▲ 禁止拆卸、撞击、挤压或投入火中,若出现严重鼓胀,请勿继续使用。
- ▲ 请勿放置在超过50度的高温环境中。
- ▲ 请勿将闪光灯头正对人眼闪光(特别是婴儿的眼睛),否则可能会在短时间内造成视力障碍。
- ▲ 请勿在化学品、可燃性气体或其他特殊物质附近使用闪光灯,这些物质在特殊情况下可能对闪光灯发出的瞬间强光敏感,有可能导致火灾或电磁干扰。在这些场合下,请注意相关警告标识。
- ▲ 本产品不能防水,在雨天及潮湿环境下请注意防水。
- ▲ 若发生任何故障,请立即关闭闪光灯电源。

目录

01	前言
02	警告
05	部件名称
	机身
	液晶显示屏
	标配物品
	可选购附件
08	如何更换其他卡口卡盘及安装附件
08	如何装卸反光罩(或附件)
08	如何装卸闪光灯管
09	如何调节闪光灯角度
09	如何拆卸支架
09	如何拆卸把手
09	电池
10	电源管理
10	无线模式选择
11	闪光模式--TTL自动闪光模式
	 闪光曝光补偿
	 高速同步
12	闪光模式--M: 手动闪光
	色温恒定功能
14	闪光模式--Multi: 频闪闪光
15	无线闪光拍摄: 无线电(2.4G)传输
	无线设置
	设置通讯频道
	设置通讯组别
	无线闪光拍摄
18	C.Fn: 设置自定义功能
19	造型灯
19	其他应用
	同步插孔触发
20	保护功能
21	规格参数
22	故障排除指南
22	固件升级
22	维护保养

本说明书中使用的约定

- 此使用说明书中的操作步骤假定相机和闪光灯的电源开关已开启。
- 参考页码由(第**页)表示。
- 此使用说明书中使用以下警告符号：
 该“小心”符号表示避免出现拍摄问题的警告。
 该“注意”符号提供补充信息。

部件名称

机身：

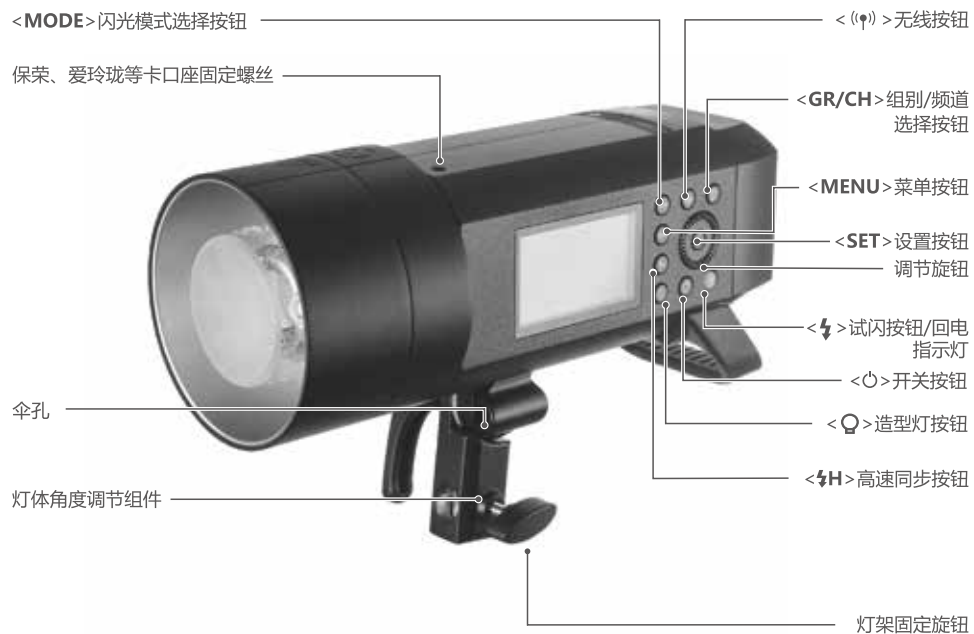

部件名称

机身：



液晶显示屏

(1) TTL自动闪光

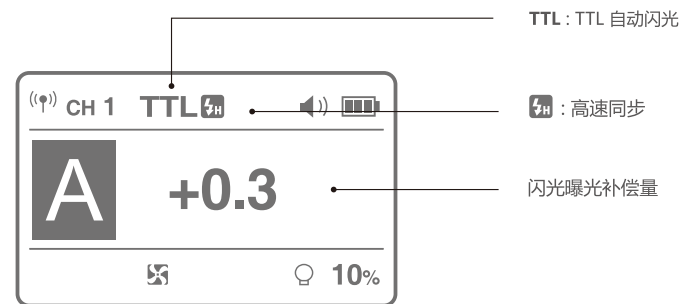

部件名称

液晶显示屏

(2)M手动闪光

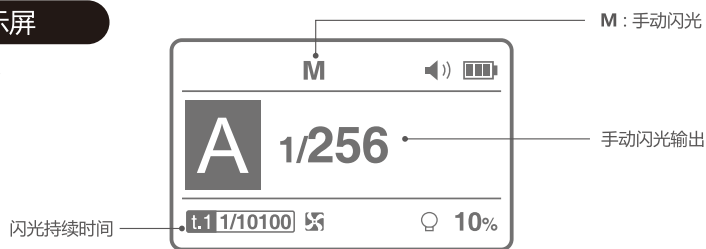

(3)Multi频闪闪光

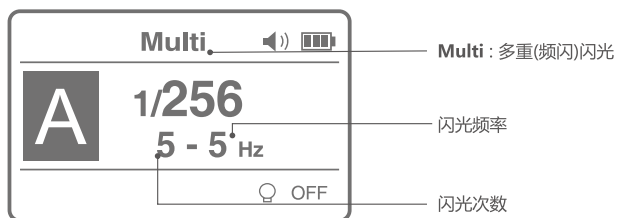

(4)无线电传输拍摄

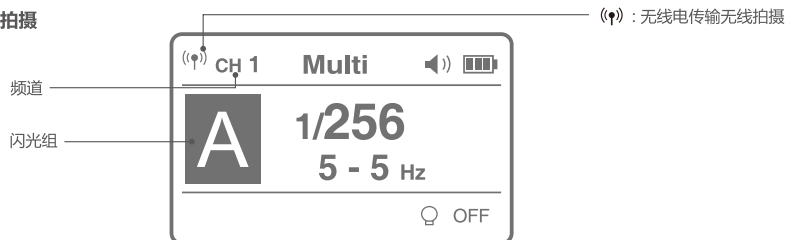

(5)无线光控拍摄

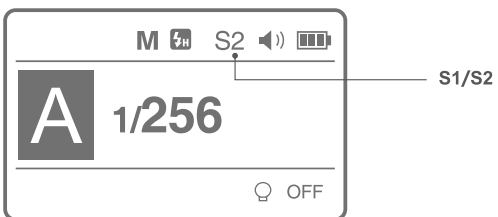

标配物品

- 1、灯管
- 2、锂电池
- 3、充电器
- 4、电源线
- 5、反光罩
- 6、保荣口适配卡盘
- 7、扳手
- 8、便携包
- 9、说明书



部件名称

可选购附件

AD400Pro可搭配本公司以下摄影附件使用,以获得最佳的拍摄效果和使用体验: XPro引闪器、X1引闪器、柔光箱、雷达罩、折叠柔光伞、束光筒、灯架等。



如何更换其他卡口卡盘及安装附件



- 1、拨动灯罩固定拨扭,卸下反光罩或其他附件。

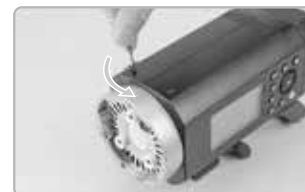

- 2、卸下灯头上2枚卡口固定螺丝。

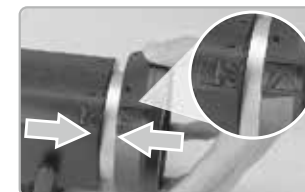

- 3、使保荣口卡盘或其它卡盘的附件固定拨扭对准机身附件固定拨扭,套入机身。

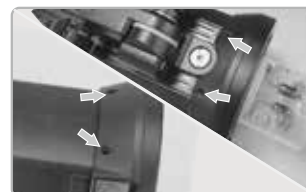

- 4、使用卸下的2颗螺丝和卡口另外配的2颗螺丝固定卡盘。



- 5、将保荣附件或其他对应卡盘的附件插入附件卡口。

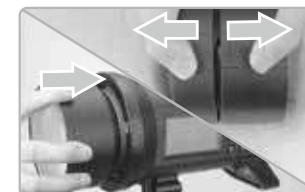

- 6、如果在安装了其他品牌卡口卡盘后,还需要使用新神牛卡口系列附件,请拆反光罩(左右手各拿一头,用力掰开),插入新神牛卡口转接新神牛附件,或直接安装新神牛口柔光箱(保富图卡口卡盘除外)。

如何装卸闪光灯管

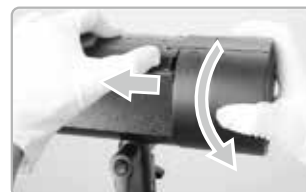

- 1、拨动灯罩固定拨扭,卸下反光罩或者其他附件。



- 2、将闪光灯管对准闪光灯插座,插入闪光灯。



注: 运输过程中,请将灯管卸下,避免破损。

如何调节闪光灯角度

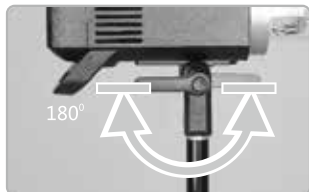

1、手柄固定件未拔出状态下，顺时针锁紧，逆时针旋松。



2、灯角度调节限制在灯体下方0-180度，碰到灯体前请把手柄固定件拉出调整旋转角度之后继续动作1。

如何拆卸支架



1、找到一枚一元硬币或大小匹配的内六角扳手，插入支架固定螺丝，逆时针旋松，即可卸下支架。

如何拆卸把手



1、使用标配扳手，插入把手固定螺丝，逆时针旋松，即可卸下把手。

电池

特性

1. 本品采用锂电池,支持反复充放电 > 300次,使用寿命长。
2. 安全可靠,内置电路有过充保护、过放保护、过流保护、短路保护。
3. 使用标配电池充电器只需2个小时左右。

注意事项

- ▲ 避免正负极短路。
- ▲ 电池没有防水功能,不要把电池浸泡在雾、水中。
- ▲ 放置于儿童不易接触的地方。
- ▲ 电池充电不要放置超过24小时。
- ▲ 电池应放置于凉爽、干燥及通风的地方存储。
- ▲ 电池不要靠近和放置于火中。
- ▲ 电池使用报废后请按当地的规定处理。
- ▲ 长期不使用,请充电至60%左右再放置。
- ▲ 如果电池超过3个月不使用,请对电池进行充电。

装卸电池

安装电池：



1 电池扣对准主机上的电池扣滑槽插入。



2 往下滑动，听到电池扣“咔嚓”的声音，即为安装到位。

拆卸电池：



1 往主机后方拨动电池锁扣。



2 往上滑动，取出电池。

电池电量指示

将锂电池正确安装在闪光灯上,即可给闪光灯供电。使用时请查看闪光灯屏幕上电池图标,即可随时掌握电量状态。

LCD屏电量符号显示 (针对整个闪光灯系统的 电量指示和管理)	电池上LED显示 (无负载下针对电池 电量的指示和管理)	意义/电量百分比
3格	1红+3绿	75% ~ 100%
2格	1红+2绿	50% ~ 75%
1格	1红+1绿	25% ~ 50%
无格	1红	3% ~ 25%
低电,充电提示	2%红灯闪烁, 1%指示灯不亮	< 2%电量即将用尽,此状态不支持闪光灯工作,前一分钟报警提示,3分钟后将自动关机。 注:此状态请尽快(10天内)充电,才可使用或放置。

注：显示大体一致,但在档位交替时会有些差别。

电源管理

*长按1秒电源开关按钮控制该产品的打开和关闭,长时间不使用时请关闭电源。本产品设计有电源自动关机功能。在C.Fn-STANDBY设置的时间(30-120min)无人操作时,闪光灯会自动关闭。

无线模式选择

AD400Pro只能作为从属单元(接收端),通过按无线按钮进行切换。

闪光模式——TTL自动闪光模式

该闪光灯有TTL自动闪光，M手动闪光，Multi频闪光三种模式。在TTL模式下，相机的测光系统会侦查从主体反射回来的闪光照明，从而自动调节闪光输出量，使主体和背景得到均衡曝光。

* 按下 < MODE > 模式选择按钮，三种闪光模式将会依次出现在液晶屏上。

TTL模式

* 通过按 < MODE > 模式选择按钮，将闪光灯设置为 < TTL >，可以使闪光灯进入TTL模式。

闪光曝光补偿

该闪光灯可以在±3档间以1/3档为增量调节闪光曝光补偿。由于环境的需求而需要微调TTL系统时，这个功能非常有用。

设置闪光曝光补偿：

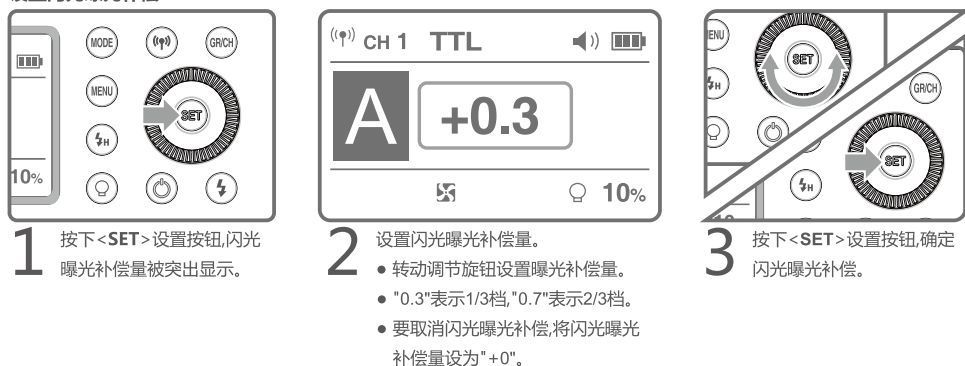

高速同步

使用高速同步(FPI闪光)，您可以在所有的快门速度下同步使用闪光灯。高速同步模式下，使用光圈优先对人像进行填充闪光时特别方便。

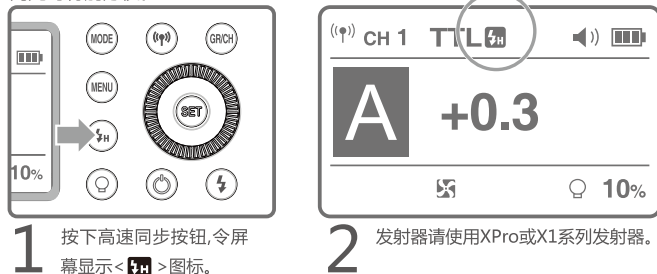

- 如果设置快门速度等于或慢于相机的最大闪光同步速度，取景器中将不显示 < FH > 图标。
- 使用高速同步，快门速度越高，有效的闪光范围就越小。
- 要恢复普通闪光，请再次按高速同步按钮。 < FH > 图标会消失。
- 在高速同步模式下，无法设置频闪光。
- 连续高速同步闪光50次后，闪光灯热保护功能可能会被激活。

闪光模式——M: 手动闪光

您可以在1/256功率至1/1全功率间以0.1档为增量设置闪光输出。为获得正确的闪光曝光，请使用手持的闪光测光表确定所需的闪光输出。



S1光控单元设置

在M手动闪光模式下，按 <MENU> 按钮进入 C.Fn - SLAVE 选择 S1 功能，闪光灯可作为副灯使用，创造多种照明效果，适用于手动闪光环境。它会与主闪光灯的第一次闪光同步触发闪光，效果与使用无线引闪器一致。

S2光控单元设置

按 <MENU> 按钮进入 C.Fn - SLAVE 选择 S2 功能，闪光灯可作为副灯使用，适用于TTL闪光环境。具有防预闪功能，使用带一次预闪功能的相机能用光控实现同步拍摄。它会与主闪光灯的第二次闪光同步触发闪光，即2次光控引闪。

• 只有在M模式下才支持S1/S2光控引闪模式。

闪光模式——M: 手动闪光

显示闪光持续时间

闪光持续时间是指闪光灯从开始发光到达发光半峰值的时间长度。半峰值的表示为 $t=0.5$ 。为了给摄影师提供更详细的拍摄数值,本产品采用 $t=0.1$ 。如下图: $t=0.5$ 与 $t=0.1$ 区别。

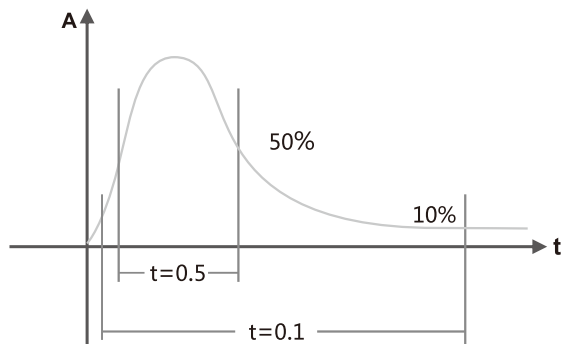

- 只有在M模式下才会显示持续时间。

色温恒定

使用此功能全档位色温漂移在 $\pm 75K$ 左右: 进入MENU C.Fn-COLOR, 设置为ON, 色温恒定开启。在M模式下功率值由大调小时, 引闪按钮指示灯会闪烁(蜂鸣器响一分钟), 此时请按引闪按钮放电, 后可正常使用。

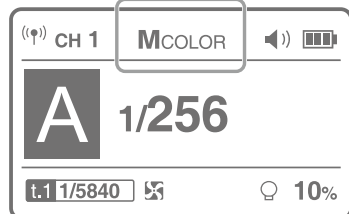
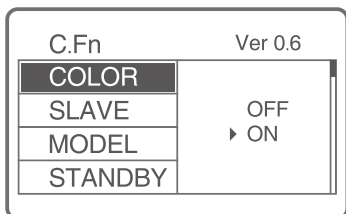

- 只有在M非高速模式下才支持色温恒定。

闪光模式——Multi: 频闪闪光

使用频闪闪光, 可以发出一系列快速的闪光。它可以在一张照片上拍摄移动物体的多个图像。您可以设置闪光频率(每秒的闪光次数, 以Hz表示)、闪光次数和闪光输出。

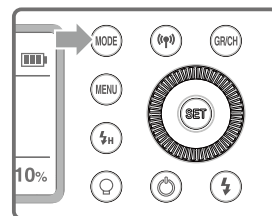

1 按<MODE>闪光模式选择按钮, 屏幕显示<MULTI>。

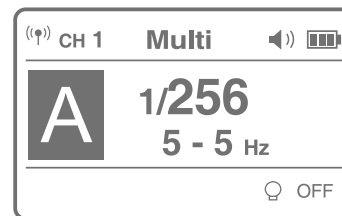

2 转动调节旋钮设置闪光输出功率。

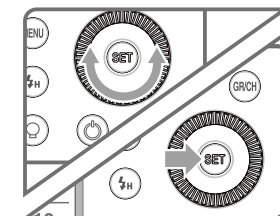

3 设置闪光频率和闪光次数。
 • 按<SET>按钮选择闪光次数, 旋转调节旋钮设定数字。
 • 按<SET>按钮选择闪光频率, 旋转调节旋钮设定数字。
 • 按下<SET>设置按钮确定, 所有设置都将显示出来。

计算快门速度

在频闪闪光过程中, 到闪光停止为止快门应保持开启状态。使用下面的公式计算快门速度, 然后用相机进行设置。

$$\text{闪光次数} / \text{闪光频率} = \text{快门速度}$$

例如, 如果闪光次数是10, 闪光频率是5Hz, 快门速度则至少为2秒。

⚠ 为防止闪光灯过热并损坏, 请勿执行连续10次以上的频闪闪光连拍。闪光10次后, 请让闪光灯至少冷却15分钟。如果您试图执行连续10次以上的频闪闪光连拍, 为防止闪光灯过热, 闪光可能自动停止。如果发生了这种情况, 请让闪光灯至少冷却15分钟。

- 反光很强的被摄体在暗背景前使用频闪闪光更加有效。
- 推荐使用三脚架和遥控开关。
- 闪光输出为1/1和1/2时不能设置频闪闪光。
- 频闪闪光时也可以使用“bulb”。
- 如果闪光次数显示为--, 则闪光灯会连续闪光, 直到快门或电池耗尽。如下表所示, 闪光次数将受到限制。

最大频闪闪光次数

闪光输出 \ Hz	1	2	3	4	5	6-7	8-9	10	11	12-14	15-19	20-50	60-100
1/4	7	6	5	4	3	3	3	2	2	2	2	2	2
1/8	14	14	12	10	8	6	5	4	4	4	4	4	4
1/16	30	30	30	20	20	20	10	8	8	8	8	8	8
1/32	60	60	60	50	50	40	30	20	20	20	18	16	12
1/64	90	90	90	80	80	70	60	50	40	40	35	30	20
1/128	100	100	100	100	100	90	80	70	70	60	50	40	40
1/256	100	100	100	100	100	90	80	70	70	60	50	40	40

无线闪光拍摄：无线电(2.4G)传输

AD400Pro使用神牛2.4G无线X系统,可以与本厂其他型号完美结合使用。作为从属单元可兼容的相机有佳能E-TTL II、尼康i-TTL、索尼、奥林巴斯、松下、富士,根据主控单元自动切换,无需手动设置。

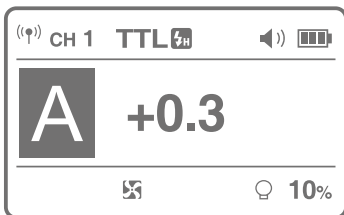

*AD400Pro作为从属单元,可受控带无线发射功能的主控单元,型号如下:

XPro系列、X1T系列、AD360II系列、V860II系列、V850II、V350系列、TT685系列、TT600系列、TT350系列等。

无线设置

按下<(P)>无线设置按钮,令屏幕显示<(P)>。

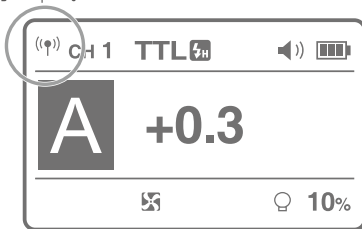
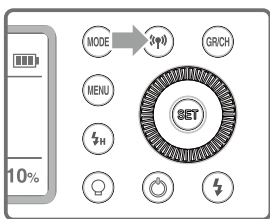

设置通讯频道

如果在拍摄现场不止一个无线闪光系统,您可以通过更改通讯频道或设置ID号来防止信号干扰。保证主控单元和从属单元设置为相同的频道编号即可。

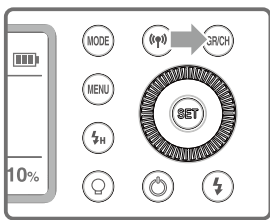

1 长按<GR/CH>按钮2秒,频道值会被选中。



2 旋转调节旋钮从1至32中选择频道。

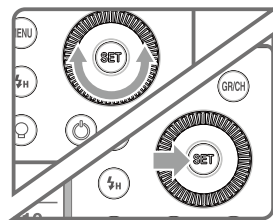

3 按下<SET>设置按钮确定。

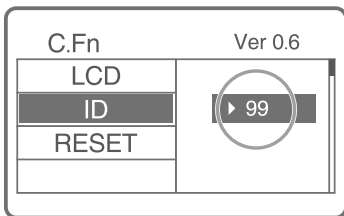

4 ID号设置,按MENU按钮进入C.Fn-ID可选择01-99任意数字
(注:主控单元具备此功能时才能使用)。

无线闪光拍摄：无线电(2.4G)传输

设置通讯组别

短按<GR/CH>按钮,A~E组别依次改变。

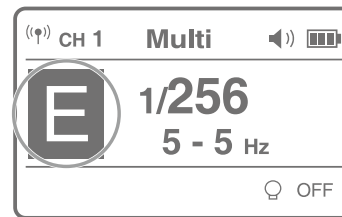
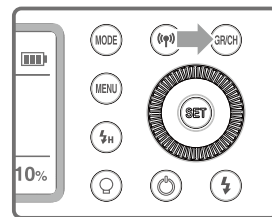

无线闪光拍摄

定位和操作范围(无线闪光拍摄的示例)

- 使用一个从属单元进行自动闪光拍摄

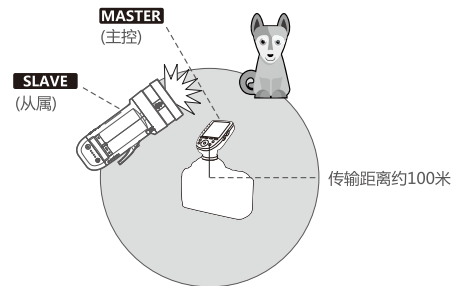

- 使用带无线发射功能的主控单元作为发射端。
- 开始拍摄前请进行测试闪光和试拍。
- 受位置、周围环境、天气状况等影响,传输距离可能更短。

无线闪光拍摄：无线电(2.4G)传输

无线多重闪光拍摄

可以将从属单元分割为两个或三个组并在改变闪光光比(倍率)的同时进行TTL自动闪光拍摄。此外,可以为各闪光组设定并用不同的闪光模式拍摄。

- 用两个从属组进行自动闪光拍摄。

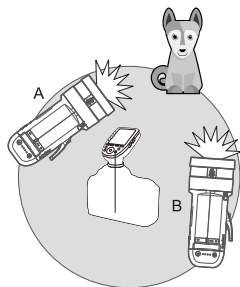

- 用三个从属组进行自动闪光拍摄。

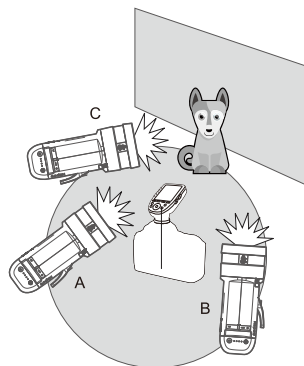

⚠ 神牛2.4G无线漏闪的原因及解决办法:

1、外部环境2.4G信号干扰(如无线基站、2.4G wifi路由、蓝牙设备等)

→请调节引闪器的频道CH设置(建议+10),找到无干扰的频道来工作,或者在工作时关闭其他2.4G设备。

2、请确认闪光灯是否已经回电或者回电速度是否已经跟上连拍速度(闪光灯就绪指示灯已经亮起),并且没有处于过热保护或者其他异常状态中

→请下调闪光灯功率的档位,如是TTL模式请尝试改为M模式(TTL模式下需要预闪一次)。

3、是否引闪器和闪光灯距离太近(距离<0.5m)

→请在引闪器上打开“近距离无线模式”:

X1系列:按住引闪按钮不放,然后开机,直至指示灯闪2次。

Xpro系列:设置C.Fn-DIST为0-30m。

4、是否引闪器和接收端设备在低电状态

→请更换电池(引闪器电池建议使用1.5V一次性碱性电池)。

C.Fn: 设置自定义功能

自定义功能符号	功能	设置符号	设置和说明	使用范围限制
COLOR	色温恒定	ON	启动	M非高速模式
		OFF	关闭	
SLAVE	S1/S2光控模式选择	OFF	关闭	M模式
		S1	S1模式	
		S2	S2模式	
MODEL	造型灯	CONT	常亮	无
		INTER	闪光灯回电灭	
STANDBY	自动关机	OFF	关闭	无
		30min	没有任何操作 自动关机	
		60min		
		90min		
		120min		
LIGHT	背光点亮时间	15sec	15秒后自动熄灭	无
		OFF	一直熄灭	
		ON	一直点亮	
DELAY	延时闪光	OFF, 0.01~30S	可作为后帘引闪	M/Multi模式
UNITS	闪光灯总数	2~4	UNITS与ALT必须结合使用: UNITS设置了总灯数; ALT设置了此灯在 触发几次后引闪	M模式
ALT	触发次数引闪	1-4		M模式
LCD	液晶屏对比度	-3~+3	7个级别	
ID	无线ID	OFF	关闭	无线模式
		01-99	可以选择01-99任意一个数字	
BEEP	蜂鸣器	ON	开启	无
		OFF	关闭	
RESET	参数重置	NO		无
		YES	重置	

1. 按下<MENU>按钮进入C.Fn菜单。右上角"Ver x.x"表示软件版本号。

2. 选择自定义功能符号。

- 旋转调节旋钮设置自定义功能符号。

3. 更改设置。

- 按<SET>设置按钮,自定义功能编号突出显示。
- 旋转调节旋钮设置想要的编号,按<SET>按钮确定。

4. 退出C.Fn菜单。

- 按<MENU>按钮退出。

造型灯

造型灯

AD400Pro配置30W LED造型灯，2种长亮模式。

- 造型灯有3种模式：OFF,百分比和PROP。短按造型灯按钮三种模式依次出现在显示屏上(TTL模式时只有OFF和百分比2种模式)。
 - OFF：关闭造型灯。
 - 百分比：10%~100%(为防止过热，< 30%风扇低速转，> 30%风扇高速转)。
 - RPOP：通过改变输出功率来调整造型灯亮度，功率越大造型灯越亮(为防止过热，< 1/64风扇低速转，> 1/64风扇高速转)。
- 长按造型灯按钮2秒可调节造型灯百分比(10%~100%)。

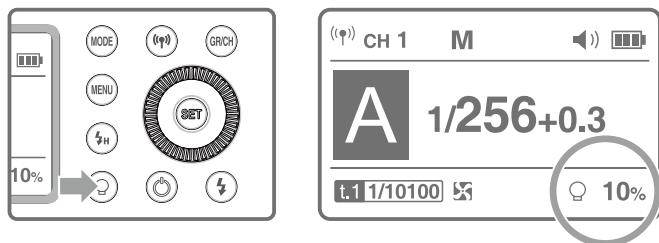

其他应用

同步插孔触发

同步插孔规格为Φ3.5mm，此处可插入同步线或者触发器触发插头对闪光灯进行同步引闪。

保护功能

1. 热保护

- 为防止闪光灯头过热并损坏,请勿在1/1功率时进行超过75次的快速连续闪光。75次连续闪光后,要让闪光灯至少冷却5分钟。
- 如您在进行超过75次连续闪光后马上继续进行更多次闪光,内部的防过热功能可能会被激活,使充电时间变为10秒以上。如果发生这种现象,请让闪光灯冷却约5分钟,闪光灯便会恢复正常。
- 热保护启动后,显示屏上⚠的符号会显示。

激活热保护功能的连续闪光次数：

功率	次数
1/1	75
1/2(+0.7~+0.9)	100
1/2(+0.3~+0.6)	120
1/2(+0.0~+0.2)	150
1/4(+0.0~+0.9)	200
1/8(+0.0~+0.9)	300
1/16(+0.0~+0.9)	400
1/32(+0.0~+0.9)	500
1/64(+0.0~+0.9)	1000
1/128(+0.0~+0.9)	
1/256(+0.0~+0.9)	

高速同步模式下,激活热保护功能的连续闪光次数：

功率	次数
1/1	50
1/2(+0.0~+0.9)	60
1/4(+0.0~+0.9)	75
1/8(+0.0~+0.9)	100
1/16(+0.0~+0.9)	150
1/32(+0.0~+0.9)	200
1/64(+0.0~+0.9)	
1/128(+0.0~+0.9)	300
1/256(+0.0~+0.9)	

2. 其他保护

- 为了保证设备安全的工作,系统时刻进行预防保护,以下提示符号供您参考：

LCD显示	警示内容
Error 1	闪光灯回电系统出现问题,无法回电引闪,请重新开机,如无法解决请维修
Error 3	闪光灯管两端电压过高,请维修
Error 9	固件升级有误,请进行正确固件升级

规格参数

型号	AD400Pro	
无线从属单元模式	*无线电模式 (兼容佳能E-TTL II、尼康i-TTL、索尼、奥林巴斯、松下、富士)	
闪光模式	无线关闭	M/Multi
	无线电从属模式	TTL/M/Multi
闪光指数(1/1档位)	72 (m ISO 100,使用高效反光罩)	
闪光持续时间	1/230秒 - 1/12340秒	
POWER	400Ws	
档位	9级:1/256~1/1	
频闪闪光	具备 (次数:100次; 频率:100Hz)	
闪光曝光补偿(FEC)	手动,闪光包围曝光:在±3档间以1/3档为增量调节	
同步方式	高速同步(最高1/8000秒),前帘同步,后帘同步	
延时引闪	0.01~30秒	
蒙板	√	
风扇	√	
蜂鸣器	√	
Model造型灯(LED)	30W/4800K/TLIC: 93	
光控引闪	S1/S2	
显示闪光持续时间	√	
显示	点阵屏	
无线闪光(2.4G无线电传输)		
无线功能	从属单元,关闭	
可控制从属单元组	2.4G	5组:A,B,C,D,E
传输范围(约)	2.4G	100米
频道	2.4G	32组:1~32
无线ID	2.4G	为了避免干扰,除了改变无线传输频道还可以通过改变无线ID,主控单元和从控单元无线ID、频道一致才能触发。
电源		
电源	锂电池(21.6V/2600mAh)	
全功率闪光次数	380	
回电时间	约0.01-1秒	
电池电量指示	√	
节能	可设置闪光灯在无人操作30min~120min自动关闭电源	
同步触发方式	3.5mm同步线	
色温	5600±200K	
色温恒定模式	全程档位波动±75K	
尺寸		
体积(含电池)	220x102x128mm (不含灯管和反光罩)	
净重(含电池)	2.1 Kg (不含灯管和反光罩)	

故障排除指南

如果遇到问题,请参阅此故障排除指南。

闪光曝光不足或过度。

- 使用高速同步。
→使用高速同步,有效的闪光范围会更小。确保被摄体位于显示的有效闪光范围内。
- 闪光灯使用手动曝光模式。
→改为**TTL**模式或修改闪光输出功率设置。

固件升级

本机通过USB插座可进行固件升级。软件最新公告及说明将会发布在官方网站上。

- 本品出厂不配USB升级线,请另行购买。本产品USB接口为Type-C接口,请使用Type-C USB线。
- 产品升级固件需要Godox G3程序软件支持,升级固件前请先下载安装“Godox G3固件升级软件”再选择相应的固件文件。
- 由于产品进行固件升级,说明书请以最新电子版为准。

维护保养

- 闪光灯在工作时,如发现异常,应立即关掉电源,查明原因。
- 灯体应避免震动,平时注意表面除尘。
- 灯体稍有发热为正常现象,无特别需要时,勿连续引闪。
- 闪光灯的所有维修概由本厂指定可供原厂配件之维修部负责。
- 1年保修,消耗品如灯管等,不在1年保修范围。
- 经发现,擅自检修此闪光灯的,将取消闪光灯之一年保修期,维修需要收取相关费用。
- 如果本品出现故障或者被水淋湿,在专业人员维修后方可继续使用。
- 如有技术更改,恕不另行通知。

Foreword

Before using this product

Please read this user manual carefully in order to ensure your safety and the proper operation of this product. Keep for future reference.

Thank you for purchasing a GODOX product.

WITSTRO All-in-One Outdoor Flash AD400Pro has strong power, all-in-one lithium battery pack and great portability. When using Godox 2.4G wireless X system off camera, AD400Pro can be triggered by XPro and X1 series flash trigger in TTL/M/Multi mode, etc. With master & slave functions, AD400Pro can also use in combination with Godox TTL camera flashes, TTL outdoor flashes, TTL studio flashes, etc. With this AD400Pro flash, your shooting will become simpler. You can easily achieve a correct flash exposure even in complex light-changing environments.



WITSTRO AD400Pro offers studio quality light for outdoor and live shooting with strong power and large capacity lithium battery pack. The powerful and portable AD400Pro meets the demands of freelance commercial photographers, photojournalists, wedding and beach portraiture shooters, event and backpack photographers, photograph enthusiasts, etc. The AD400Pro offers:

- **Quick recycle time:** 0.01-1s.
- **Stable color temperature mode:** color temperature changes within $\pm 75K$ over the entire power range.
- **LED modeling lamp:** 30W LED modeling lamp whose light brightness can be freely adjusted.
- **Precise power output:** power adjusts from full power 1/256 to 1/1 in 25 steps.
- **Advanced functions:** 1/8000s high-speed sync flash, multi flash, high-speed sync triggering, etc.
- **Compatible wireless TTL system:** with built-in Godox 2.4G wireless X system, AD400Pro is compatible with Canon, Nikon, Sony, FUJIFILM, Olympus and Panasonic TTL autoflash system.
- **Wireless control:** with built-in Godox 2.4G wireless X system to achieve TTL control. It can also be used to wirelessly adjust flash power level and trigger the flash through the wireless control port. AD400Pro has 3.5mm sync cord jack to achieve various sync triggering mode.
- **Dot-matrix LCD panel:** with clear and convenient operation.
- **Studio quality light:** up to 400Ws, GN 72 (m ISO 100, with high-efficiency standard reflector).
- With New Godox-mount and the included Bowens-mount adapter ring, AD400Pro can install different accessories by replacing its adapter ring(separately sold), such as accessories of Broncolor, Prophoto, Elinchrom, etc.



Warning

- ▲ Always keep this product dry. Do not use in rain or in damp conditions.
- ▲ Do not disassemble. Should repairs become necessary, this product must be sent to an authorized maintenance center.
- ▲ Keep out of reach of children.
- ▲ Stop using this product if it breaks open due to extrusion, falling or strong hit. Otherwise, electric shock may occur if you touch the electronic parts inside it.
- ▲ Do not fire the flash directly into the eyes (especially those of babies) within short distances. Otherwise visual impairment may occur.
- ▲ Do not use the flash unit in the presence of flammable gases, chemicals and other similar materials. In certain circumstance, these materials may be sensitive to the strong light emitting from this flash unit and fire or electromagnetic interference may result.
- ▲ Do not leave or store the flash unit if the ambient temperature reads over 50°C. Otherwise the electronic parts may be damaged.
- ▲ Turn off the flash unit immediately in the event of malfunction.

Contents

23	Foreword
24	Warning
27	Name of Parts
	Body
	Control Panel
	LCD Panel
	Included Accessories
	Separately Sold Accessories
30	Replacing Adapter Rings and Accessories
30	Installing Reflector (Other Accessories)
30	Attaching Flash Tube
30	Adjusting Handle
31	Detaching the Mounting Bracket
31	Detaching the Handle
31	Battery
32	Power Management
32	Wireless Flash Mode
33	Flash Mode— TTL Autoflash
	 FEC (Flash Exposure Compensation)
	 High-Speed Sync
34	Flash Mode—M: Manual Flash
	Stable Color Temperature Function
36	Flash Mode—Multi/Stroboscopic Flash
37	Wireless Flash Shooting: Radio (2.4G) Transmission
	Wireless Settings
	Setting the Communication Channel
	Setting the Communication Group
	Wireless Flash Shooting
40	C.Fn: Setting Custom Functions
41	Modeling Lamp
41	Other Applications
	Sync Triggering
42	Protection Function
43	Technical Data
44	Troubleshooting
44	Firmware Upgrade
44	Maintenance

Conventions used in this Manual

- This manual is based on the assumption that both the camera and camera flash's power switches are powered on.
- Reference page numbers are indicated by "p.**".
- The following alert symbols are used in this manual:
 -  The Caution symbol indicates a warning to prevent shooting problem.
 -  The Note symbol gives supplemental information.

Name of Parts

Body:

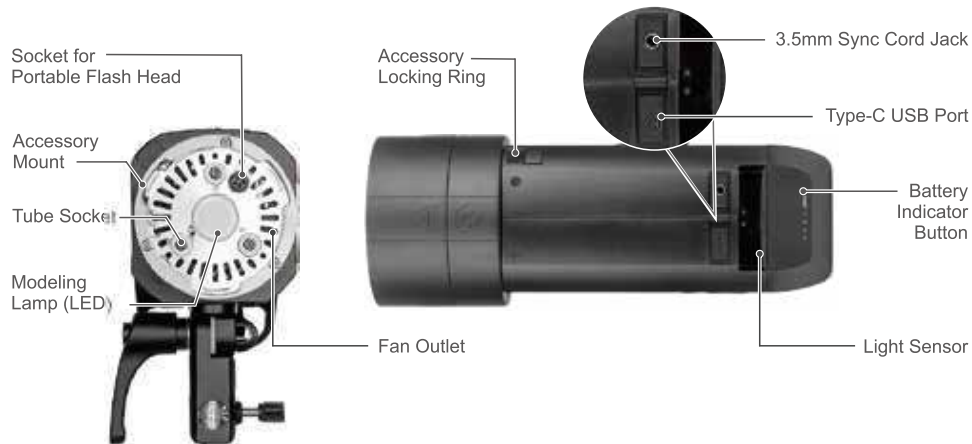
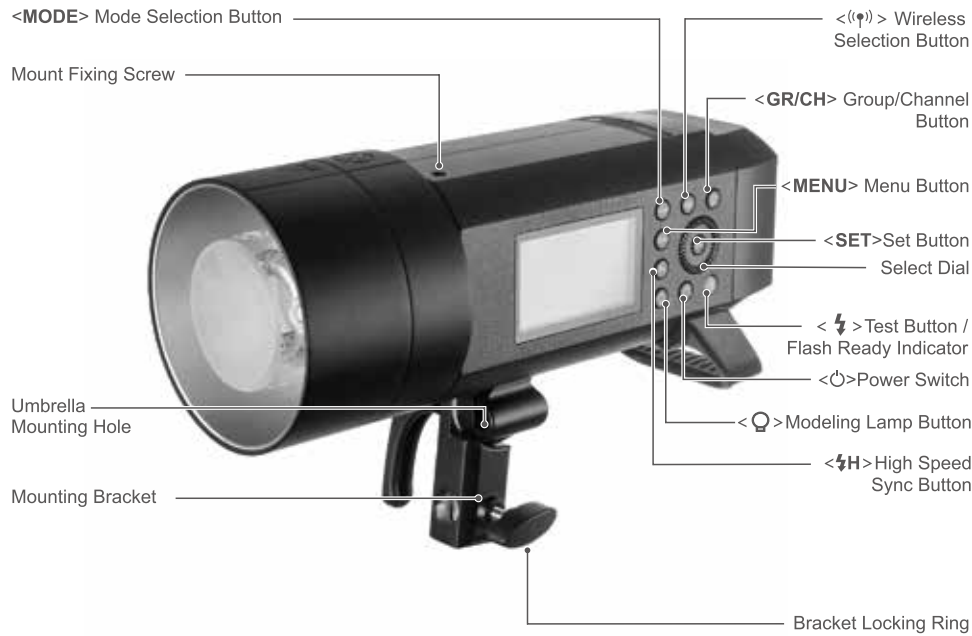

Name of Parts

Body:

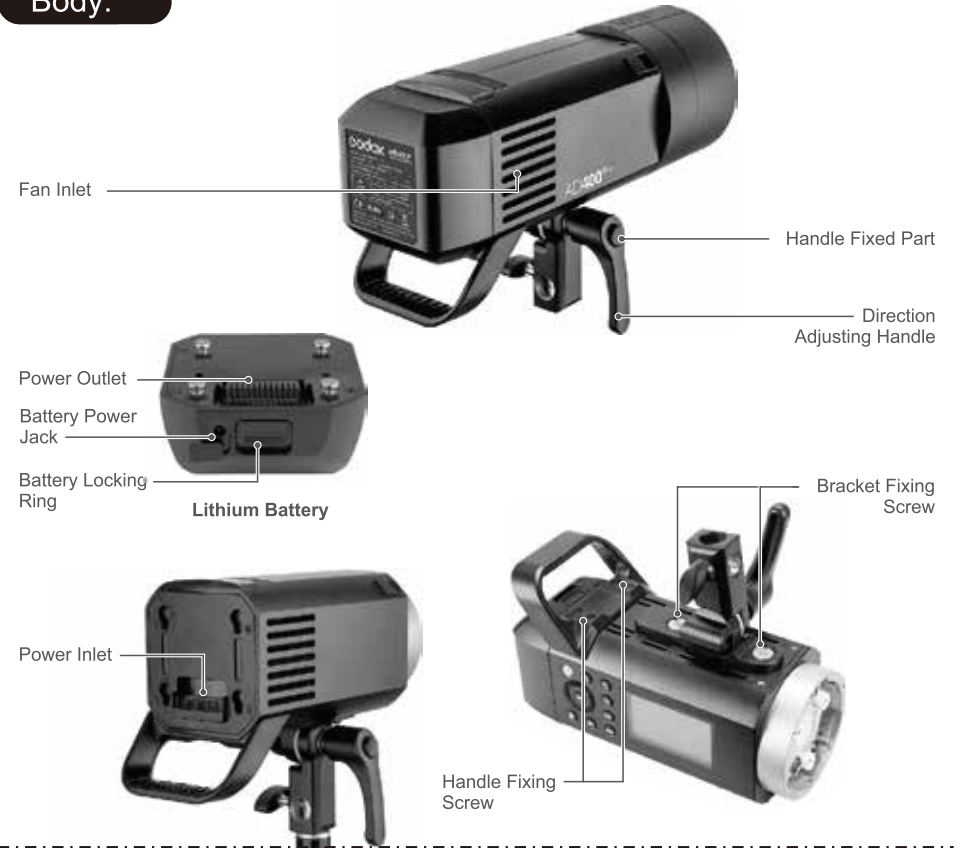

LCD Panel:

(1) TTL Autoflash

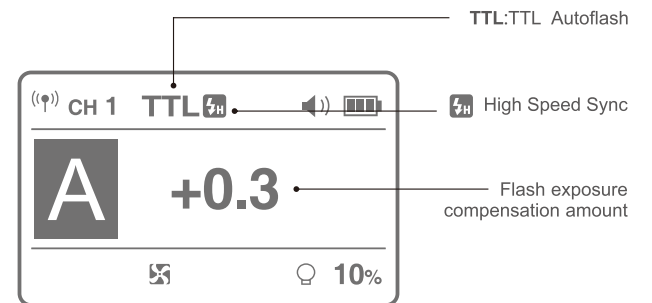

Name of Parts

LCD Panel:

(2) M Manual Flash

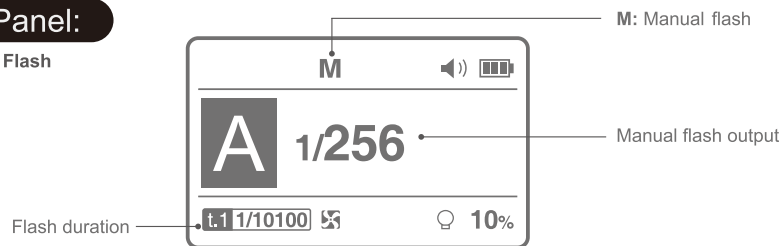

(3) Multi Flash

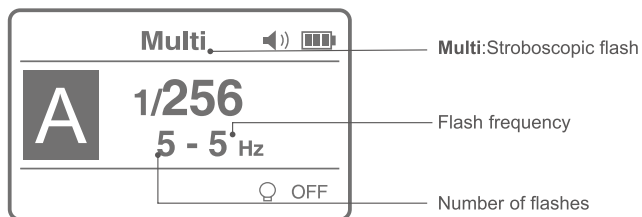

(4) Radio Transmission Shooting

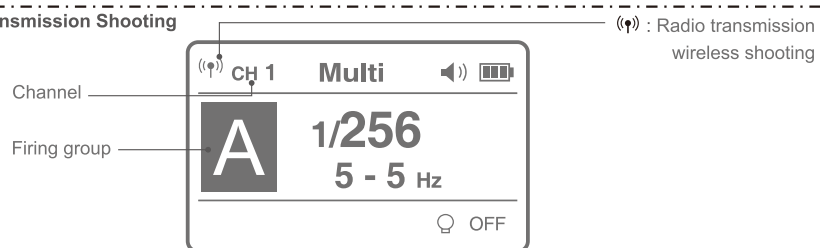

(4) Optical transmission wireless shooting

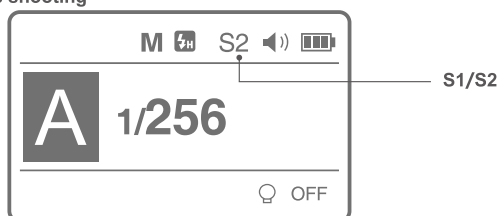

Included Accessories

1. Flash tube 2. Lithium battery pack 3. Battery charger 4. Power cord 5. Standard Reflector
6. Bowens-mount adapter ring 7. Wrench 8. Portable Bag 9. Instruction manual



Name of Parts

Separately Sold Accessories

The product can be used in combination with the following accessories sold separately, so as to achieve best photography effects: Xpro & X1 Wireless Flash Trigger, Softbox, Beauty Dish, Fold up Umbrella, Snoots, Light Stand, etc.



Replacing Adapter Rings and Accessories



1. Remove the reflector or other accessories from the flash head.



2. Loosen the two Mount Fixing Screws.

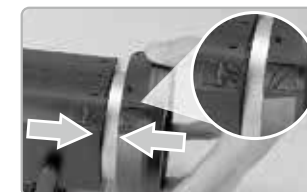

3. Match the Accessory Locking Ring of Bowens-mount or other mount adapter ring to the Accessory Locking Ring of the flash and push it in.

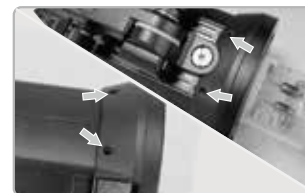

4. Tighten the two screws and use another two screws provided to fix.



5. Install the Bowens-mount accessories or other corresponding accessories.

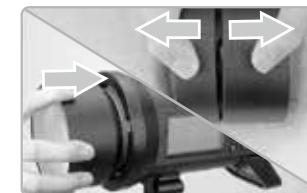

6. If needed to use new Godox-mount accessories after installing the adapter ring of other brand, please split the reflector and insert it into the new Godox mount to install the required accessories (How to detach the standard reflector: hold the two ends and detach it.). Or install the new Godox-mount softbox directly (except for Profoto-mount adapter ring).

Attaching Flash Tube

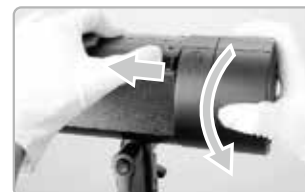

1. Remove the reflector or other accessories from the flash head.



2. Match the flash tube in the Tube Socket. Push the flash tube in until it is securely seated into the socket.



 • Note: To avoid damage, please detach the flash tube during the transportation.

Adjusting Handle

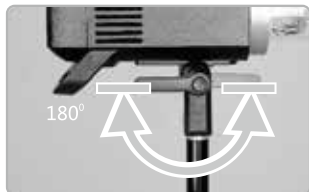

1. When the Direction Adjusting Handle is not pulled out, screw clockwise while unscrew anti clockwise.

2. The Direction Adjusting Handle's rotation angle should be restrained from 0 to 180 degrees below the flash body. Please pull out the Direction Adjusting Handle, adjust the appropriate angle, and manipulate the step 1 before colliding with the flash body.

Detaching the Mounting Bracket



1. Insert a coin or corresponding wrench(not included) into the Bracket Fixing Screw and loosen it anti-clockwise to detach.

Detaching the Handle



1. Insert the included wrench into the Handle Fixing Screw and loosen it anti-clockwise to detach.

Battery

Features

1. This flash unit uses Li-ion polymer battery which has long runtime. The available charge-and-discharge times are over 300.
2. It is reliably safe. The inner circuit is against overcharge, overdischarge, overcurrent, and short circuit.
3. Take only 2 hours to fully charge the battery by using the standard battery charger.

Cautions

- ▲ Do not short circuit.
- ▲ Do not expose to rain or immerse into water. This battery is not water proof.
- ▲ Keep out of reach of children.
- ▲ No over 24 hours' continuous charging.
- ▲ Store in dry, cool, ventilated places.
- ▲ Do not put aside or into fire.
- ▲ Dead batteries should be disposed according to local regulations.
- ▲ Please charge the battery to approx. 60% before being placed for long time.
- ▲ If the battery had ceased using for over 3 months, please make a full recharge.

Loading and Unloading the Battery Pack

Loading:



1 Match the buckles of the battery and the main body. .



2 Push down the battery pack until it is locked.



1 Push the Battery Locking Ring backwardly.



2 Push the battery pack upward to unload it.

Battery Level Indication

Attach the battery pack to the flash correctly. Be aware of the battery level by check the battery level indication on the LCD panel when using.

Battery Level Indication on the LCD Panel (Indicating battery level and management of the whole flash system)	LED Battery Level Indication on the Battery (Indicating battery level and management of non-loaded battery)	Meaning/Percentage of Battery Level
3 grids	1 red grid +3 green grids	75%~100%
2 grids	1 red grid +2 green grids	50%~75%
1 grid	1 red grid +1 green grid	25%~50%
Blank grid	1 red grid	3%~25%
Low battery and charging reminder 	2%: red light blinks 1%: the indicator is off.	<2% The battery level is going to be used out immediately. And the flash will alarm for the 1 minute and auto power off in 3 minutes. Note: Please recharge the battery as soon as possible (within 10 days). Then, the battery can be used or be placed for long period.

Note: The indications are almost the same except of grids shift.

Power Management

Long press the Power Switch for 1 seconds to control the on/off of the flash unit. Turn off the power pack if the flash unit will not be used for an extended period. This product has auto power off function. The flash will auto power off in 30 to 120 min. which is set on C.Fn-STANDBY.

Wireless Flash Mode

AD400Pro can only be set as slave unit (receiver end). Press Wireless Selection Button to switch.

Flash Mode — TTL Autoflash

This flash has three flash modes: TTL, Manual (M), and Multi (Stroboscopic). In TTL mode, the camera and the flash will work together to calculate the correct exposure for the subject and the background.

* Press <MODE> Mode Selection Button and three flash modes will display on the LCD panel one by one with each pressing.

TTL Mode

Press <MODE > Mode Selection Button to enter TTL mode. The LCD panel will display <TTL> .

FEC: Flash Exposure Compensation

With FEC function, this flash can adjust from -3 to +3 in 1/3rd stops. It is useful in situations where minor adjusting of the TTL system is needed based on the environment.

Setting FEC:

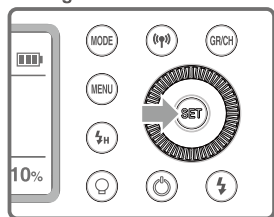

1 Press <SET> Button and flash exposure compensation amount will be highlighted on the LCD panel.

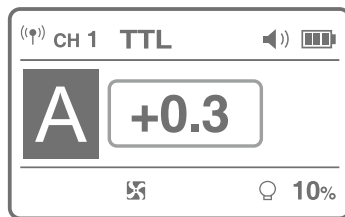

2 Set the flash exposure compensation amount.

- Turn the Select Dial to set the amount.
- "0.3" means 1/3 step, "0.7" means 2/3 step.
- To cancel the flash exposure compensation, set the amount to "+0".

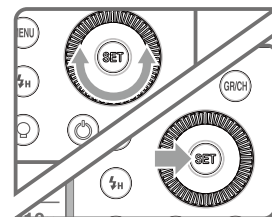

3 Press <SET > button again to confirm the setting.

High-Speed Sync

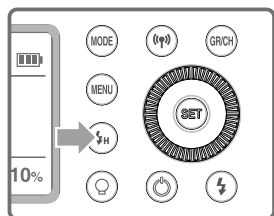

High Speed Sync (FP flash) enables the flash to synchronize with all camera shutter speeds. This is convenient when you want to use aperture priority for fill-flash portraits.

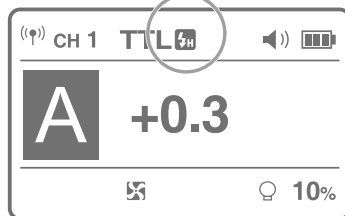

1 Press High Speed Sync Button so that <  > is displayed.



2 Please use XPro or X1 series transmitter.

- If you set a shutter speed that is the same as or slower than the camera's maximum flash sync speed, <  > will not be displayed in the viewfinder.
- With high-speed sync, the faster the shutter speed, the shorter the effective flash range.
- To return to normal flash, press <  > button again. Then <  > will disappear.
- Multi flash mode cannot be set in high-speed sync mode.
- Over-temperature protection may be activated after 50 consecutive high-speed sync flashes.

Flash Mode — M: Manual Flash

The flash output is adjustable from 1/1 full power to 1/256th power in 0.1 stop increments. To obtain a correct flash exposure, use a hand-held flash meter to determine the required flash output.

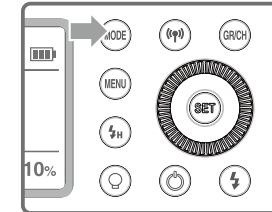

1 Press <MODE > button so that <M > is displayed.

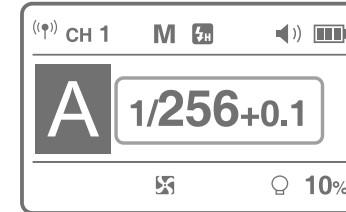

2 Turn the Select Dial to choose a desired flash output amount.

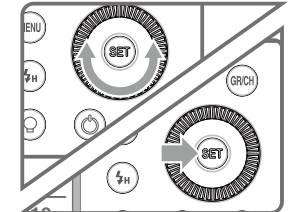

3 Press <SET > button again to confirm the setting.

Optical S1 Secondary Unit Setting

In M manual flash mode, press <MENU> button to enter C.Fn-SLAVE to choose S1 function, so that this flash can function as an optical S1 secondary flash with optic sensor. With this function, the flash will fire synchronously when the main flash fires, the same effect as that by the use of radio triggers. This helps create multiple lighting effects.

Optical S2 Secondary Unit Setting

Press < MENU > button to enter C.Fn-SLAVE to choose S2 function, so that this flash can also function as an optical S2 secondary flash with optical sensor in M manual flash mode. This is useful when cameras have pre-flash function. With this function, the flash will ignore a single "pre-flash" from the main flash and will only fire in response to the second, actual flash from the main unit.

- S1 and S2 optical triggering is only available in M manual flash mode.

Flash Mode — M: Manual Flash

Display Flash Duration

Flash duration refers to the length of time that from flash's firing to reach the half peak at maximum. The half peak at maximum is usually expressed as $t=0.5$. In order to provide the photographer with more concrete data, this product adopts $t=0.1$. The difference between $t=0.5$ and $t=0.1$ is shown in the following picture.

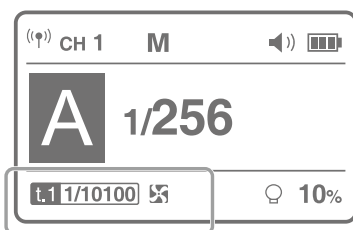
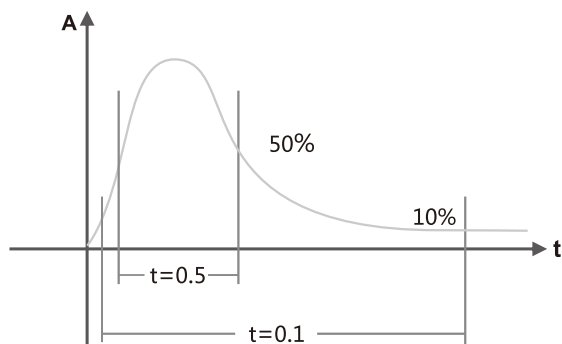

- The flash duration will only be displayed on the LCD panel in M mode.

Stable Color Temperature Function

When use this function, the color temperature changes within $\pm 75K$ over the entire power range: enter MENU C.Fn-COLOR and set it as ON, which means the color temperature function is turned on. When adjusting the power output from high to low in M mode, ζ Flash Ready Indicator will blink (the beeper will alarm for 1 minute). Now press the Test Button to discharge, and the flash can be used as normal.

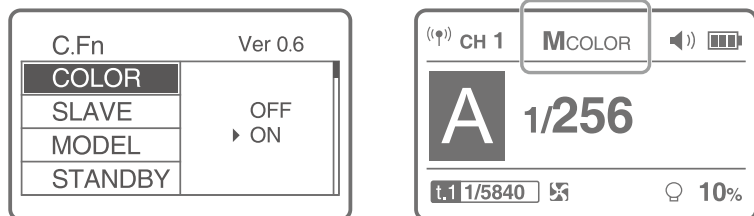

- This function can only be supported in M non-high-speed mode.

Flash Mode — Multi: Stroboscopic Flash

With stroboscopic flash, a rapid series of flashes is fired. It can be used to capture a multiple images of a moving subject in a single photograph. You can set the firing frequency (number of flashes per sec. expressed as Hz), the number of flashes, and the flash output.

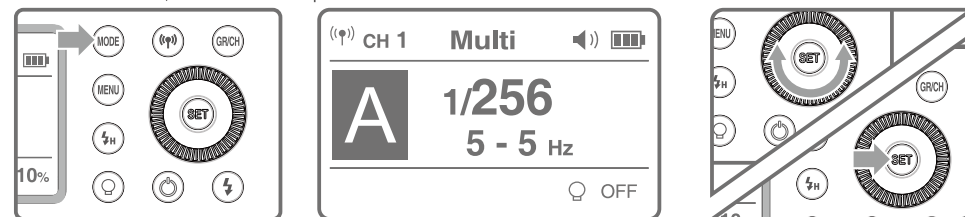

- Press <MODE> button so that <MULTI> is displayed.
- Turn the Select Dial to choose a desired flash output.
- Set the flash frequency and flash times.
 - Press <SET> Button to select the flash times. Turn the Select Dial to set the number.
 - Press <SET> Button to select the flash frequency. Turn the Select Dial to set the number.
 - After you finish the setting, press <SET> button and all the settings will be displayed.

Calculating the Shutter Speed

During stroboscopic flash, the shutter remains open until the firing stops. Use the formula below to calculate the shutter speed and set it with the camera.

$$\text{Number of Flashes} / \text{Flash Frequency} = \text{Shutter Speed}$$

For example, if the number of flashes is 10 and the firing frequency is 5 Hz, the shutter speed should be at least 2 seconds.

- ⚠ To avoid overheating and deteriorating the flash head, do not use stroboscopic flash more than 10 times in succession. After 10 times, allow the camera flash to rest for at least 15 minutes. If you try to use the stroboscopic flash more than 10 times in succession, the firing might stop automatically to protect the flash head. If this happens, allow at least 15 minutes' rest for the flash.

- Stroboscopic flash is most effective with a highly reflective subject against a dark background.
- Using a tripod and a remote control is recommended.
- A flash output of 1/1 and 1/2 cannot be set for stroboscopic flash.
- Stroboscopic flash can be used with "buLb".
- If the number of flashes is displayed as "--", the firing will continue until the shutter closes or the battery is exhausted. The number of flashes will be limited as shown by the following table.

Maximum Stroboscopic Flashes:

Flash Output \ Hz	1	2	3	4	5	6-7	8-9	10	11	12-14	15-19	20-50	60-100
1/4	7	6	5	4	4	3	3	2	2	2	2	2	2
1/8	14	14	12	10	8	6	5	4	4	4	4	4	4
1/16	30	30	30	20	20	20	10	8	8	8	8	8	8
1/32	60	60	60	50	50	40	30	20	20	20	18	16	12
1/64	90	90	90	80	80	70	60	50	40	40	35	30	20
1/128	100	100	100	100	100	90	80	70	70	60	50	40	40
1/256	100	100	100	100	100	90	80	70	70	60	50	40	40

Wireless Flash Shooting: Radio (2.4G) Transmission

AD400Pro adopts Godox 2.4G wireless X system, which has good compatibility with other products of our company.

As a slave unit, AD400Pro is automatically compatible with Canon E-TTL II, Nikon i-TTL, Sony, Olympus, Panasonic and FUJIFILM system according to the master unit.

*As a slave unit, AD400Pro can be controlled by the following master units: XPro series, X1T series, AD360II series, V860II series, V350 series, TT685 series, TT600 series, TT350 series, etc.

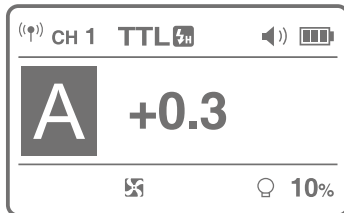

1. Wireless Settings

Press <(())> Wireless Setting Button again until <(())> is displayed on the panel.

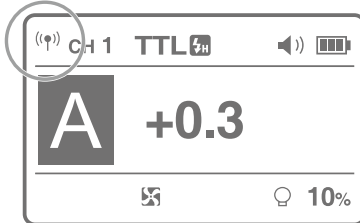
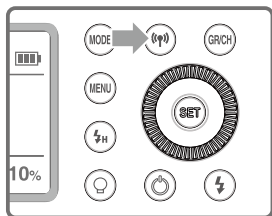

2. Setting the Communication Channel

If there are other wireless flash systems nearby, you can change the channel IDs to prevent signal interference. The channel IDs of the master unit and the slave unit(s) must be set to the same.

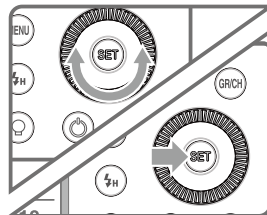
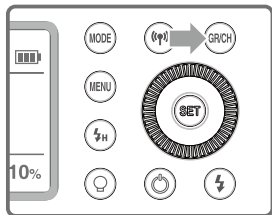

1 Long press the <GR/CH> Button for 2 seconds so that channels ID is displayed on the LCD panel.

2 Turn the Select Dial to choose a channel ID from 1 to 32.

3 Press the <SET> button to confirm.

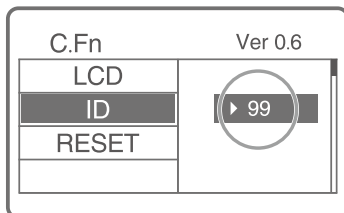

4 Wireless ID setting: press the MENU button to enter C.Fn-ID and choose from 01 to 99 (Note: this can only be achieved when the master unit also has this function).

Wireless Flash Shooting: Radio (2.4G) Transmission

3. Setting the Communication Group

Short press the <GR/CH> Button to choose group ID from A to E.

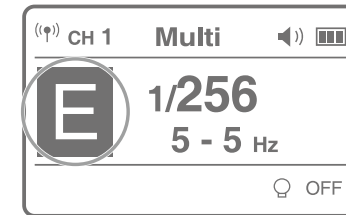
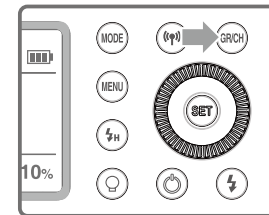

4. Wireless Flash Shooting

Positioning and Operation Range (Example of wireless flash shooting)

- Autoflash Shooting with One Slave Unit

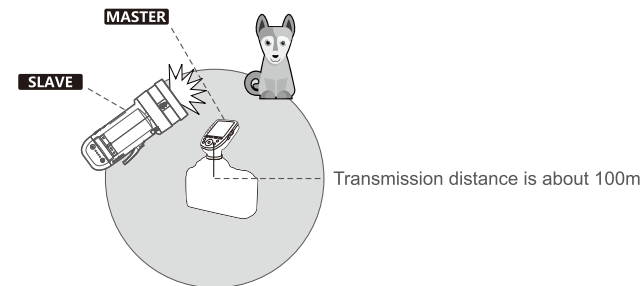

- Use master unit with wireless transmitting function as the transmitter end.
- Before shooting, perform a test flash and test shooting.
- The transmission distance might be shorter depending on the conditions such as positioning of slave units, the surrounding environment and whether conditions.

Wireless Flash Shooting: Radio (2.4G) Transmission

Wireless Multiple Flash Shooting

You can divide the slave units into two or three groups and perform TTL autoflash while changing the flash ratio (factor). In addition, you can set and shoot with a different flash mode for each firing group.

• Auto Shooting with Two Slave Groups

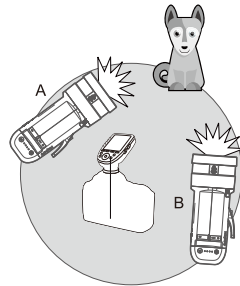

• Auto Shooting with Three Slave Groups

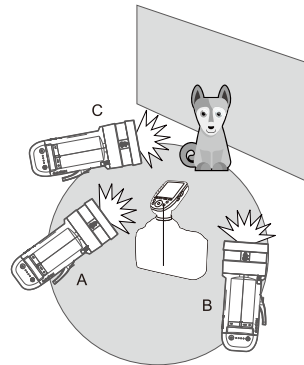

⚠ The Reason & Solution of Not Triggering in Godox 2.4G Wireless

1. Disturbed by the 2.4G signal in outer environment (e.g. wireless base station, 2.4G wifi router, Bluetooth, etc.)

→ To adjust the channel CH setting on the flash trigger (add 10+ channels) and use the channel which is not disturbed. Or turn off the other 2.4G equipment in working.

2. Please make sure that whether the flash has finished its recycle or caught up with the continuous shooting speed or not (the flash ready indicator is lighten) and the flash is not under the state of over-heat protection or other abnormal situation.

→ Please downgrade the flash power output. If the flash is in TTL mode, please try to change it to M mode (a preflash is needed in TTL mode).

3. Whether the distance between the flash trigger and the flash is too close or not

→ Please turn on the "close distance wireless mode" on the flash trigger (< 0.5m):

X1 series: press the test button and hold on, then turning it on until the flash ready indicator blinks for 2 times.

XPro series: Set the C.Fn-DIST to 0-30m.

4. Whether the flash trigger and the receiver end equipment are in the low battery states or not

→ Please replace the battery (the flash trigger is recommended to use 1.5V disposable alkaline battery).

C.Fn: Setting Custom Functions

Custom Function Signs	Functions	Setting Signs	Settings & Descriptions	Restrictions
COLOR	Stable color temperature	ON	ON	M Non high-speed mode
		OFF	OFF	
SLAVE	S1/S2 mode selection	OFF	OFF	M mode
		S1	S1 mode	
		S2	S2 mode	
MODEL	Modeling lamp	CONT	Continuous lighting	NO
		INTER	Off after finishing the flash recycle	
STANDBY	Auto power off	OFF	OFF	NO
		30min	Auto power off without any operation	
		60min		
		90min		
120min				
LIGHT	Backlighting time	15sec	Off in 15 sec.	NO
		OFF	Always off	
		ON	Always lighting	
Delay	Delay flash	OFF, 0.01~30S	Can be triggered as second curtain	M/Multi mode
UNITS	Total number of flashes	2~4	Use UNITS in combination with ALT: UNITS sets the total number of flashes; ALT sets the triggering times before flash's firing	M mode
ALT	Triggering times	1-4		M mode
LCD	LCD contrast	-3 ~ +3	7 levels	
ID	Wireless ID	OFF	off	Wireless mode
		01-99	Choose from 01 to 99	
BEEP	Beeper	ON	ON	NO
		OFF	OFF	
RESET	Parameter resetting	NO	Reset	NO
		YES		

1. Press < MENU > Button to enter C.Fn menu. The "Ver x.x" in the top-right corner refers to the software version.

2. Select the Custom Function Signs.

• Turn the Select Dial to select the Custom Function Signs.

3. Change the Setting.

• Press < SET > button and the setting signs are highlighted.

• Turn the Select Dial to set the desired number. Press < SET > button will confirm the settings.

4. Exit C.Fn Menu.

• Press < MENU > Button to exit.

Modeling Lamp

Modeling Lamp

AD400Pro is equipped with a 30W LED modeling lamp which has two continuous lighting modes.

• There are three modes: OFF, Percentage and PROP. Short press the Modeling Lamp Button, and the three mode will be displayed on the LCD panel in sequence:

1. OFF: the modeling lamp is off.
2. Percentage: 10%~100%(to prevent overheat, <30% the fan rotates in low speed while >30% in high speed).
3. PROP: The modeling lamp's power changes with the flash's power. The bigger power the flash has, the brighter the modeling lamp is(to prevent overheat, <1/64 the fan rotates in low speed while >1/64 in high speed).

• Long press the modeling lamp for 2 seconds to adjust the percentage of modeling lamp from 10% to 100%.

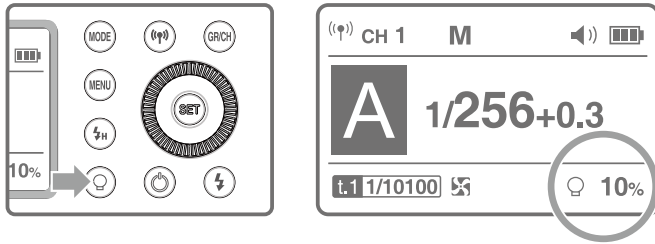

Other Applications

Sync Triggering

The Sync Cord Jack is a $\Phi 3.5\text{mm}$ plug. Insert a trigger plug here and the flash will be fired synchronously with the camera shutter.

Protection Function

1. Over-Temperature Protection

- To avoid overheating and deteriorating the flash head, do not fire more than 75 continuous flashes in fast succession at 1/1 full power. After 75 continuous flashes, allow a rest time of at least 5 minutes.
- If you fire more than 75 continuous flashes and then fire more flashes in short intervals, the inner over-temperature protection function may be activated and make the recycling time over 10 seconds. If this occurs, allow a rest time of about 5 minutes, and the flash unit will then return to normal.
- When the over-temperature protection is started,  is shown on the LCD display.

Number of flashes that will activate over-temperature protection:

Power Output Level	Number of Flashes
1/1	75
1/2 (+0.7~+0.9)	100
1/2 (+0.3~+0.6)	120
1/2 (+0.0~+0.2)	150
1/4 (+0.0~+0.9)	200
1/8 (+0.0~+0.9)	300
1/16 (+0.0~+0.9)	400
1/32 (+0.0~+0.9)	500
1/64 (+0.0~+0.9)	1000
1/128 (+0.0~+0.9)	
1/256 (+0.0~+0.9)	

Number of flashes that will activate over-temperature protection in high-speed sync triggering mode:

Power Output	Times
1/1	50
1/2 (+0.0~+0.9)	60
1/4 (+0.0~+0.9)	75
1/8 (+0.0~+0.9)	100
1/16 (+0.0~+0.9)	150
1/32 (+0.0~+0.9)	200
1/64 (+0.0~+0.9)	300
1/128 (+0.0~+0.9)	
1/256 (+0.0~+0.9)	

2. Other Protections

- The system provides real-time protection to secure the device and your safety. The following lists prompts for your reference:

LCD Panel	Meaning
Error 1	A failure occurs on the recycling system so that the flash cannot fire. Please restart the flash unit. If the problem still exists, please send this product to a maintenance center.
Error 3	The voltage on two outlets of the flash tube is too high. Please send this product to a maintenance center.
Error 9	There are some errors occurred during the upgrading process. Please using the correct firmware upgrade method.

Technical Data

Model	AD400Pro	
Wireless Slave Unit Mode	Radio transmission mode (compatible with Canon E-TTL II, Nikon i-TTL, Sony, Olympus, Panasonic and FUJIFILM).	
Flash Mode	Wireless off	M/Multi
	Slave unit of radio transmission	TTL/M/Multi
Guide No. (m ISO 200)	72 (m ISO 100, with high-efficiency standard reflector)	
Flash Duration	1/230 to 1/12340 seconds (T0.1)	
POWER	400Ws	
Power Output	9 steps: 1/256~1/1	
Stroboscopic Flash	Provided (up to 100 times, 100Hz)	
Flash Exposure Compensation (FEC)	Manual. Feb: ±3 stops in 1/3 stop increments.	
Sync mode	High-speed sync (up to 1/8000 seconds), first-curtain sync, and second-curtain sync	
Delay Flash	0.01~30 Seconds	
Mask	√	
Fan	√	
Beeper	√	
Modeling Lamp (LED)	30W/4800K/TLIC: 93	
Optical Slave Flash	S1/S2	
Flash Duration Indication	√	
Display	Dot-matrix panel	
• Wireless Flash (2.4G wireless transmission)		
Wireless Flash Function	Slave, Off	
Controllable Slave Groups	5 (A, B, C, D, E)	
Transmission Range (approx.)	100m	
Channels	32 (1~32)	
Wireless ID	To avoid signal interference effectively, triggering can only be achieved when the channels and wireless IDs of the master and slave unit are set to the same.	
• Power Supply		
Power Supply	Lithium battery pack (21.6V/2600mAh)	
Full Power Flashes	380	
Recycle Time	Approx. 0.01-1s	
Battery Indicator	√	
Power Indication	Power off automatically after approx. 30~120 minutes of idle operation.	
• Sync Triggering Mode	3.5mm sync line	
• Color Temperature	5600±200K	
• Stable Color Temperature Mode	Changes within ±75K in entire power range	
• Dimensions		
Dimension (with battery)	220x102x128 mm (flash tube & reflector not included)	
Net Weight (with battery)	2.1 Kg (flash tube & reflector not included)	

Troubleshooting

If there is a problem, refer to this Troubleshooting Guide.

The flash exposure is underexposed or overexposed.

- You used high-speed sync.
 - With high-speed sync, the effective flash range will be shorter. Make sure the subject is within the effective flash range displayed.
- You used Manual Flash mode.
 - Set the flash mode to TTL or modify the flash output.

Firmware Upgrade

This flash supports firmware upgrade through the USB port. Update information will be released on our official website.

- USB connection line is not included in this product. As the USB port is a Type-C USB socket, please use the Type-C USB line.
- As the firmware upgrade needs the support of Godox G3 software, please download and install the "Godox G3 firmware upgrade software" before upgrading. Then, choose the related firmware file.
- As the products needs to do firmware upgrade, please refer to instruction manual of the newest electric version as final.

Maintenance

- Shut down the device immediately should abnormal operation be detected.
- Avoid sudden impacts and the product should be dedusted regularly.
- It is normal for the flash tube to be warm when in use. Avoid continuous flashes if unnecessary.
- Maintenance of the flash must be performed by our authorized maintenance department which can provide original accessories.
- This product, except consumables e.g. flash tube, is supported with a one-year warranty.
- Unauthorized service will void the warranty.
- If the product had failures or was wetted, do not use it until it is repaired by professionals.
- Changes made to the specifications or designs may not be reflected in this manual.

FCC

This device complies with part 15 of the FCC Rules. Operation is subject to the following two conditions: (1) This device may not cause harmful interference, and (2) this device must accept any interference received, including interference that may cause undesired operation.

Any Changes or modifications not expressly approved by the party responsible for compliance could void the user's authority to operate the equipment.

Note: This equipment has been tested and found to comply with the limits for a Class B digital device, pursuant to part 15 of the FCC Rules. These limits are designed to provide reasonable protection against harmful interference in a residential installation. This equipment generates uses and can radiate radio frequency energy and, if not installed and used in accordance with the instructions, may cause harmful interference to radio communications. However, there is no guarantee that interference will not occur in a particular installation. If this equipment does cause harmful interference to radio or television reception, which can be determined by turning the equipment off and on, the user is encouraged to try to correct the interference by one or more of the following measures:

- Reorient or relocate the receiving antenna.
- Increase the separation between the equipment and receiver.
- Connect the equipment into an outlet on a circuit different from that to which the receiver is connected.
- Consult the dealer or an experienced radio/TV technician for help.

Warning

Operating frequency:2412.99MHz-2464.49MHz(only receive)

Declaration of Conformity

GODOX Photo Equipment Co.,Ltd. hereby declares that this equipment are in compliance with the essential requirements and other relevant provisions of Directive 2014/53/EU. In accordance with Article 10(2) and Article 10(10), this product is allowed to be used in all EU member states.For more information of DoC, Please click this web link:

https://www.godox.com/DOC/Godox_AD400Pro_DOC.pdf

The device complies with RF specifications when the device used at 0mm from your body.