

● 85mm T1.5 AS IF UMC II (for Cinema)

Instruction Manual

Thank you for purchasing our lens.
We believe that this new 85mm T1.5 AS IF UMC II lens for video recording will give you a special photographic experience.

The 85mm T1.5 AS IF UMC II lens completes an optical system based on superior optical technologies, and maintains excellent resolution both at the center and around the periphery of the lens by adopting a high performance Hybrid ASP lens and UMC (Ultra Multi Coating).

Advantages of the 85mm T1.5 AS IF UMC II

1. 35mm full frame image size.
2. It compensates optical aberrations using a high performance Hybrid ASP lens
3. In the fully open position, it produces high resolution and high contrast at the center of the lens as well as around the periphery.
4. The detachable petal type hood and UMC (Ultra Multi Coating) design suppresses flaring and ghost images.
5. Durable high-strength aluminum alloy
6. Smooth control when a follow focus is attached since the lens is equipped with a gear for both focus and aperture.

The 85mm T1.5 AS IF UMC II lens for video recording is designed with its own mount. You can mount the lens directly onto the camera without using an adaptor.

- ※ Please read this instruction manual carefully and use the product accordingly.
- ※ Please read the 'Safety Precautions' at the back of this instruction manual prior to use.

1. Components

【Figure】

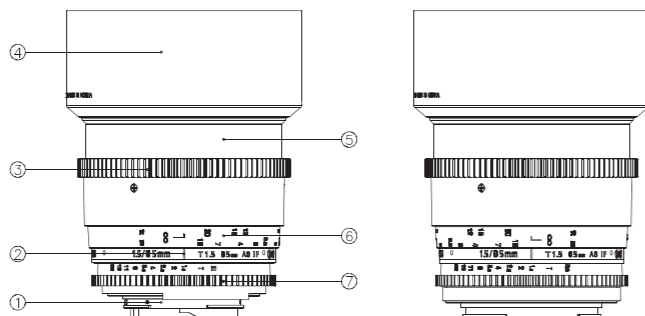

- | | |
|----------------------|-------------------------------|
| ① Mount | ② Focus & aperture index line |
| ③ Focus gear ring | ④ Hood |
| ⑤ Hood mount | ⑥ Distance scale |
| ⑦ Aperture gear ring | |

2. Attaching to and Detaching from the Camera

The 85mm T1.5 AS IF UMC II lens mount is uniquely designed for Canon, Nikon (Fujifilm) F, Pentax (Samsung GX) K, Sony (Minolta) α, Canon M, Sony E, Fujifilm X, Samsung NX, Four Thirds, and Micro Four Thirds cameras.

【Attaching】

Gently hold the lens hood, align the camera mount attachment point with the attachment reference point or line on the lens, push the lens into the camera and gently rotate the lens 90 degrees clockwise from the front view, until it makes a clicking sound.

【Detaching】

Gently hold the lens hood, press the lens release button on the camera, and turn the lens counterclockwise to detach the lens.

3. Focus Adjustment

When using the 85mm T1.5 AS IF UMC II lens, you can set the focus of a subject by turning the focus adjustment gear, since it is an MF (Manual Focus) adjustment lens.

【Nikon, Pentax Mount】

- ① To change the focus from a subject that is far away to a subject that is close, turn the focusing gear counterclockwise (from ∞ to 1.1m) and focus on the clearest subject using the indicator signal on the camera or by checking visually.
- ② To change the focus from a subject that is close to a subject that is far away, turn the focusing gear clockwise (from 1.1m to ∞) and focus on the clearest subject using the indicator signal on the camera or by checking visually.

【Canon/Canon M/ Fujifilm X/ Sony α / Sony E/ FT/MFT/NX Mount】

- ① To change the focus from a subject that is far away to a subject that is close, turn the focusing gear clockwise (from ∞ to 1.1m) and focus on the clearest subject by checking visually.
- ② To change the focus from a subject that is close to a subject that is far away, turn the focusing gear counterclockwise (from 1.1m to ∞) and focus on the clearest subject by checking visually.

4. Brightness Control

You can set the brightness you want by turning the aperture adjustment gear when using the 85mm T1.5 AS IF UMC II lens.

You can set T NO from 1.5 to 22.

(The aperture is not positioned at any exact point, since it is adjustable continuously without steps.)

5. Mounting a Hood

The hood guarantees speedy, efficient, safe and precise installation and facilitates shooting that is free from ghosting or flaring.

【Figure】

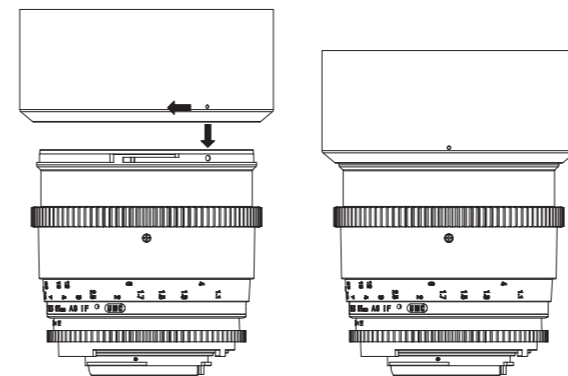

Align the attachment reference point on the hood with the hood reference point on the lens, push the hood onto the lens and turn the hood clockwise until it makes a clicking sound.

6. Camera settings

Some cameras require special settings when using this lens.

○ Canon Mount

- 1) Record a video in Av, Tv, P, CA, □ or M mode.
- 2) Please note that while recording a video the shutter speed is limited to a minimum of 1/30.

(The procedures above are for the 5D MARKII. The settings for the camera or the menu may vary based on the camera model or due to a functional upgrade. Refer to the camera manual or contact the camera manufacturer for detailed information.)

○ Nikon Mount

Please refer to the following and set the camera when necessary.

- 1) Record a video in M or A mode.
- 2) Adjust the exposure using the dial steps +5 to -5.

(The procedures above are for the D7000. The settings for the camera or the menu may vary based on the camera model or due to a functional upgrade. Refer to the camera manual or contact the camera manufacturer for detailed information.)

○ Pentax K mount

- 1) Record a video in □ mode.
- 2) Please note that while recording a video the shutter speed is limited to a minimum of 1/30.

(The procedures above are for the K-30. The settings for the camera or the menu may vary based on the camera model or due to a functional upgrade. Refer to the camera manual or contact the camera manufacturer for detailed information.)

○ Sony α Mount

- 1) Record a video in A, S, P or M mode.

(The procedures above are for the A580. The settings for the camera or the menu may vary based on the camera model or due to a functional upgrade. Refer to the camera manual or contact the camera manufacturer for detailed information.)

○ Canon M Mount

- 1) Record a video in Av, Tv, P, CA or M mode.
- 2) Please note that while recording a video the shutter speed is limited to a minimum of 1/30.

(The procedures above are for the Canon M. The settings for the camera or the menu may vary based on the camera model or due to a functional upgrade. Refer to the camera manual or contact the camera manufacturer for detailed information.)

○ Fujifilm X Mount

- 1) Record a video in □ mode.

(The procedures above are for the X-Pro1. The settings for the camera or the menu may vary based on the camera model or due to a functional upgrade. Refer to the camera manual or contact the camera manufacturer for detailed information.)

○ Sony E Mount

- 1) Record a video in A, S, P or M mode.
- 2) Adjust the exposure by rotating the dial at the back of the camera.

(The procedures above are for the NEX-5. The settings for the camera or the menu may vary based on the camera model or due to a functional upgrade. Refer to the camera manual or contact the camera manufacturer for detailed information.)

○ Samsung NX Mount

- 1) Record a video in A, M or  mode.
- 2) Please note that while recording a video the shutter speed is limited to a minimum of 1/30.

(The procedures above are for the NX-200. The settings for the camera or the menu may vary based on the camera model or due to a functional upgrade. Refer to the camera manual or contact the camera manufacturer for detailed information.)

○ Four Thirds FT Mount

- 1) Record a video in , P, A or M.
- 2) Please note that while recording a video the shutter speed is limited to a minimum of 1/30.

(The procedures above are for the E-5. The settings for the camera or the menu may vary based on the camera model or due to a functional upgrade. Refer to the camera manual or contact the camera manufacturer for detailed information.)

○ Micro Four Thirds Mount







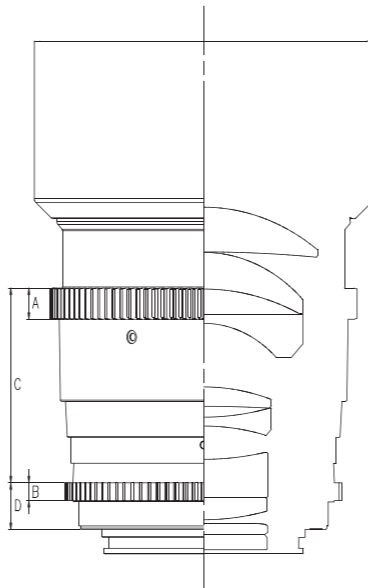

- 1) Record a video in , P, A or M.
- 2) Please note that while recording a video the shutter speed is limited to a minimum of 1/30.

(The procedures above are for the E-5. The settings for the camera or the menu may vary based on the camera model or due to a functional upgrade. Refer to the camera manual or contact the camera manufacturer for detailed information.)

7. SPEC											
SPECIFICATIONS		1:1.5 85mm AS IF UMC I									
APERTURE RANGE(T-STOP)		T1.5 to T22									
OPTICAL CONSTRUCTION		9 ELEMENTS IN 7 GROUPS (1 ASPHERICAL LENS)									
MINIMUM FOCUSING DISTANCE		1.1m(3.6ft)									
FILTER SIZE		ø 72mm									
MAXIMUM DIAMETER		ø 78mm									
MOUNT		NIKON	CANON EOS	PENTAX K	SONY α	CANON M	FUJIFILM X	SAMSUNG NX	SONY E	FOUR-THIRDS	MICRO FOUR-THIRDS
ANGLE OF VIEW	35mm	28.3°	28.3°	28.3°	28.3°	·	·	·	28.3°	·	·
	APS-C	19.1°	17.7°	19.1°	19.1°	17.7°	19.1°	19.1°	19.1°	·	·
	FOUR-THIRDS (4/3")	·	·	·	·	·	·	·	·	14.4°	14.4°
LENGTH(LENS MOUNT TO FRONT)		72.2mm	74.7mm	73.2mm	74.2mm	100.6mm	101mm	93.2mm	100.7mm	80mm	99.5mm
WEIGHT(CAP,HOOD DETACHABLE)		560g	580g	550g	570g	640g	645g	595g	605g	585g	595g
GEAR	MODULE	0.8									
	A	7mm									
	B	4mm									
	C	43.8mm									
	D	8mm	10.5mm	9mm	10mm	36.4mm	36.8mm	29mm	36.5mm	15.8mm	35.3mm
	FOCUS DIAMETER	ø 81.6mm									
APERTURE DIAMETER		ø 70.4mm	ø 73.6mm								

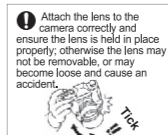

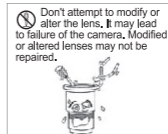
8. Troubleshooting		
Symptom	Cause	Action
The lens cannot be attached to the camera.	The reference point on the lens is not aligned with the lens attachment reference point on the camera.	Align the reference point on the lens with the lens attachment reference point on the camera.
The lens cannot be detached from the camera.	Incorrect rotation direction for detaching the lens. If you turn the lens while holding the camera, it may cause damage to the lens.	Press the lens release button on the camera, and lightly turn the lens to the lens attaching/detaching reference points, in the direction as marked on the camera, and then pull the lens forward.
Dark image.	Incorrect focusing. Insufficient shutter speed, or camera shake.	Turn the focusing ring while checking the subject using the indicator in the camera or checking visually to set the focus until the subject is clear and distinct, and then press the shutter. After selecting a shutter speed of 1/125 sec or faster, steady the camera and take a photograph.
Automatic focusing does not work properly.	This is a manual focusing lens and does not have an automatic function.	Turn the focusing gear to focus on a subject.
The pictures are too dark or too bright.	The exposure is incorrect	Set the aperture adjustment gear of the lens correctly.
The camera flash is not synchronized to the camera.	The manual focusing lens may not be compatible depending on the camera.	See the camera manual.
There is no camera finder indication or display.	This lens does not have electronic contacts, so there is no electronic communication with the camera.	This does not indicate that there is a problem with shooting.
Zoom failure.	This lens is a short focus lens.	
This lens cannot be mounted on other cameras.	This lens is designed for a specific mount type.	Please buy the required camera to use this lens.
I want to attach your 2X or 1.4X converter lens.	Our converter is designed for the T (M42 SCREW) mount only, thus it cannot be used with this lens.	Use each company's own mount converter. However, be aware that auto focusing will not be available.

9. Safety Precautions	
The following precautions are divided into two types according to the level of danger.	
⚠ WARNING If this instruction is not followed, it may cause death or severe injury to the user.	⚠ CAUTION If this instruction is not followed, it may cause death or severe injury to the user.
The following pictograms are used in the below precautions:  Requires caution. Inside the pictogram it shows contents of precautions. (It shows outbreak of fire in the pictogram on the left.)  Shows prohibition. Inside the pictogram it shows contents of prohibition. (It shows prohibition of dismantling in the pictogram on the left.)  Shows instruction. Inside the pictogram it shows contents of instructions. (It shows instruction of precaution in the pictogram on the left.)	
⚠ WARNING  Don't look at the sun through the lens. It may cause blindness.	⚠ CAUTION  Attach the lens to the camera correctly and ensure the lens is held in place properly otherwise the lens may not be removable, or may become loose and cause an accident.
 Don't leave the lens within reach of babies, as it may cause injury to the baby if the lens falls or is dropped.	 Don't attempt to modify or alter the lens. It may lead to failure of the camera. Modified or altered lenses may not be repaired.
 Don't leave the lens in direct sunlight. It may cause a fire, depending on lenses that concentrate light on a close object.	 Don't look at the sun directly through a camera with a lens attached. It may cause damage to one's eyesight.
WARNING! Do not allow this product to get wet, or expose it to a moist environment. It may cause a fire or electric shock.	
CAUTION! <ul style="list-style-type: none"> Do not use this product or store it close to devices that generate heat i.e., heaters, thermal regulators, stoves, stereo amplifiers. Do not expose the lens to drastic temperature changes. Do not touch the surface of the lens with your hand, or let it come into contact with sharp objects. Do not drop the lens. Do not soak the lens in water, and avoid water splashing onto the lens. If there are foreign bodies on the lens, use a lens cleaning kit only. 	

