



**LIGHTING SUPPORTS, CONTROLS
AND BACKGROUND SOLUTIONS**



Manfrotto

Lighting Supports, Controls and Background Solutions

Manfrotto offers the widest and most professional choice of lighting solutions to serve the photographic, broadcast and entertainment industries.

We hope you find the catalogue inspiring and useful.

For all the news that's still too new to print, please visit

www.manfrotto.com

Contents

4	STANDS
44	AUTOPOLE® SYSTEM
50	TETHERGEAR
58	CLAMPS
74	ARMS
84	TILT HEADS
88	STILL LIFE
94	BACKGROUND SUPPORTS
100	CHROMA KEY FX BACKGROUND
102	LIGHT CONTROL
106	SKY TRACK SYSTEM
118	ADAPTERS
124	INDEX

To understand the icons, consult the key to symbols on the back page.

December 2023



Stands

Manfrotto's range of stands consists of several product families which differ in design and materials depending both on the applications they are intended for and on the light type they have to support. These supports can be distinguished by the materials they are made of (aluminum or steel) and two tubing technologies (electrowelding or extrusion). Special attention has been paid to multiple technical solutions like pneumatic damping and levelling legs. The existing versions allow for extensions between 21cm and 550cm, with payloads between 1.5kg and 200kg.

MODEL	PRODUCTS	CODE
BABY LIGHTWEIGHT	Backlite Stand	012B
	Nano Pole stand	MS0490A
	Black ALU LOW Mini Pro Stand	156BLB
	Black ALU NANO Stand	5001B
	Black ALU AIR Cushioned Mini Compact Stand	1051BAC
	Black ALU AIR Cushioned Compact Stand	1052BAC
	Black ALU AIR Cushioned Master Stand	1004BAC
	Black ALU AIR Cushioned Ranker Stand	1005BAC
JUNIOR STANDS	Black ALU Stand	008BU
	STEEL Junior Stand	008CSU
	Black ALU Senior Stand	007BU
	Black STEEL Senior Stand	007BSU
	STEEL Senior Stand	007CSU
	Black STEEL Tall Stand	111BSU
	STEEL Tall Stand	111CSU
	Black STEEL Heavy Duty Stand	126BSU
	STEEL Heavy Duty Stand	126CSU
	Black ALU Super Stand	269BU
	Black STEEL Super Stand	270BSU
	STEEL Super Stand	270CSU
	Black ALU High Super Stand	269HDBU
	Extensions Black ALU Stand	142B
	Extensions STEEL High Stand	146CS
Extensions STEEL Stand	142CS	
Extensions ALU High Stand	146B	
ROLLER	STEEL Column Stand	231CS
	Black ALU Column Stand	231B
	Black Baby Studio Stand	299B
	Black ALU studio Stand	298B
	BASE Black Large Brake	297BBASE
	Base Black Large Foot	297FBASE
	Base Black Small Brake	299BBASE
Base Black Small Foot	299FBASE	
WIND-UP	STEEL 3-section Low Base Wind Up Stand	087NWL
	STEEL 2-section Low Base Wind Up Stand	083NWL
	STEEL Wind Up Stand	087NW
	Black STEEL Wind Up Stand	087NWB
	STEEL Short Wind Up Stand	087NWSH
	STEEL 2-section Wind Up Stand	083NW
	STAINLESS STEEL Super Wind Up Stand	387XU
Black STAINLESS STEEL Super Wind Up Stand	387XBU	
LIGHTING BOOMS & BOOM STANDS	Black ALU Combi-Boom Stand with Sandbag	420B
	Combi-Boom Stand HD	420CSU
	Black Mega Boom (stand not included)	425B
	Black Light Boom 35 (stand not included)	085BSL
	Black Light Boom 35 (stand included)	085BS
	Black Super Boom (stand not included)	025BSL
	Black Super Boom (stand included)	025BS
	Black Light Boom (stand not included)	024B
	Super Boom with Column Stand	025TM
	Black Wall Boom (stand not included)	098B
Black Short Wall Boom (stand not included)	098HB	

PAYLOAD								HEIGHT & WEIGHT			ATTACHMENT
≤ 2 kg	≤ 5 kg	≤ 10 kg	≤ 15 kg	≤ 20 kg	≤ 25 kg	≤ 30 kg	≥ 30 kg	cm	cm	kg	
✓								85	48	1,32	Spigot 5/8" M, 3/8" thread Male
✓								195	49	1,07	
✓								123	40	1,50	
✓								190	48	0,93	
	✓							211	67	1,00	
	✓							237	86	1,20	
		✓						366	107	3,00	
			✓					237	100	2,00	Receiver 5/8" F / diameter 17mm M (JP), Spigot 5/8" M, 1/4" W thread Male, 3/8" thread Male
			✓					212	112	4,20	Bushings 1 1/8" F, Spigot 5/8" M, 3/8" thread Male
						✓		216	116	6,40	
			✓					315	122	3,00	
				✓				325	122	7,30	
					✓			325	122	7,30	
						✓		380	155	9,00	
							✓	380	155	9,00	
							✓	333	131	8,30	
							✓	333	131	8,30	
							✓	455	144	8,00	
							✓	477	144	13,50	
							✓	477	144	13,50	
		✓						730	173	10,00	
							Extension	210		2,40	
							Extension	314		4,80	
							Extension	210		3,60	
							Extension	314		2,80	
			✓					250	121	8,00	Spigot 5/8" M, Receiver 5/8" F, 1/4" W thread Male, 3/8" thread Male
			✓					250	121	6,40	
			✓					272	105	4,80	Receiver 5/8" F / diameter 17mm M (JP), Spigot 5/8" M, 1/4" W thread Male, 3/8" thread Male
			✓					300	125	6,00	Bushings 1 1/8" F, Spigot 5/8" M, 3/8" thread Male
							✓	52	5,70		
							✓	52	4,40		
							✓	36	4,80		
							✓	36	3,50		
							✓	276	134	16,00	Bushings 1 1/8" F, Spigot 5/8" M, 3/8" thread Male
							✓	190	112	11,00	
							✓	370	181	21,40	
							✓	370	181	21,40	
							✓	276	155	15,50	Bushings 1 1/8" F
							✓	247	153	16,00	
							✓	366	184	32,50	Receiver 5/8" F / diameter 17mm M (JP), Spigot 5/8" M, 1/4" W thread Male, 3/8" thread Male
							✓	366	184	32,50	
		✓						392	113	2,70	Receiver 5/8" F / diameter 17mm M (JP), Spigot 5/8" M, 1/4" W thread Male, 3/8" thread Male
			✓					392	113	5,60	
							6kg at max extension, 30kg at minimum extensions, both with 30kg of counterweight	320		15,00	Bushings 1 1/8" F, Receiver 5/8" F
							6kg at max extension with 7kg of counterweight	280		2,20	Receiver 5/8" F / diameter 17mm M (JP), Spigot 5/8" M, 1/4" W thread Male, 3/8" thread Male
							6kg at max extension with 7kg of counterweight	280		16,40	
							5kg at max extension with 7kg of counterweight	270		4,10	Spigot 5/8" M, 3/8" thread Male
							5kg at max extension with 7kg of counterweight	100		21,00	Spigot 5/8" M, 3/8" thread Male
							3kg at max extension with 4,5kg of counterweight	200		1,40	diameter 17mm M (JP), 5/8" (16mm) Spigot, 5/8" (16mm) Receiver, 1/4" W thread Male, 3/8" thread Male
							5kg at max extension with 7kg of counterweight	108		18,50	Spigot 5/8" M, 3/8" thread Male
							4,5kg at max extension	210		2,30	Receiver 5/8" F / diameter 17mm M (JP), Spigot 5/8" M, 1/4" W thread Male, 3/8" thread Male
		✓						122		2,00	Receiver 5/8" F / diameter 17mm M (JP), Spigot 5/8" M, 1/4" W thread Male, 3/8" thread Male

This series of Manfrotto baby lighting stands are ideal for most photographic strobe heads and lighter weight fixtures and LED lights. They fold quickly to a compact size, fitting into most lighting kits. They are the versatile and lightweight companion for shoots in studio or on location.



A stronger and more ergonomic handle helps you while securing stands into the operating position.



Just a click away from your baby. Push on the new locking device and detach one stand, ready to go.



Anti-rotation 3/8" top screw fixing, plus 1/4" adapter for matching any requirement.

Excellent protection against corrosion and wear is ensured by aluminium anodization.

Versions featuring air cushioning for preventing damage to the lighting fixture during column retraction.



A new bi-injection casting provides the photographer with a better ergonomic grip.



BACKLITE STAND 012B

Black steel base with detachable aluminium column. 2 sections, 1 riser. Ø: 22, 19mm. Solid flat legs: 20x5mm. A versatile stand allowing fixtures to mount on the ground or on the included pole for extra height.

9cm	85cm	48cm	60cm
1.32kg	Pole type 18 + type 19	3kg	Base type 1 + Spigot Art. 013



BLACK ALU LOW MINI PRO STAND 156BLB

Aluminium stand. 4 sections, 3 risers. Ø: 25, 22, 19, 16mm. Leg Ø: 16mm. Perfect for background lights.

40cm	123cm	40cm	45cm
0.62kg	1.5kg	Type 19 + Adapter Art. 015	



NANO PLUS STAND 5002BL

Manfrotto's strongest Nano Stand ever, tailored for the most demanding image makers working in the studio or on location.

52cm	197cm	52cm	105cm
1.35kg	kg	Type 19 + Adapter Art. 015	



BLACK ALU NANO STAND 5001B-1

Aluminium stand. 5 sections, 4 risers. Ø: 25, 22, 19, 16, 13mm. Solid flat legs 15x5mm. An ideal stand for kits due to its compact design.

49cm	190cm	48cm	100cm
0.93kg	1.5kg	Type 19 + Adapter Art. 015	



NANO POLE STAND MS0490A-1

Aluminum stand, compact stand with 5 sections, 4 risers. The column can be detached from the base and used as a boom.

49cm	195cm	49cm	100cm
1.07kg	1.5kg	Type 19	



CARBON NANOPOLE STAND MS0490C

Aluminium base, Carbon Fibre column, compact stand with 5 sections, 4 risers. The column can be detached from the base and used as a boom.

61cm	197cm	51cm	100cm
0.78 kg	1.5kg	Type 19	

ADAPTO

Material alternatives are crucial to provide high performance and light weight.

Adapto® is the new material specifically developed by Manfrotto for both collars and spider castings of the 1051BAC MINI COMPACT STAND and the 1052BAC COMPACT STAND.

Adapto® is a special technical polymer that is comparable to aluminium in strength, but is 50% lighter. Adapto® is an ideal material for photo imaging equipment as it has superb resistance to extreme temperatures and will not corrode or oxidize. Additionally, Adapto® is an excellent vibration absorption material, making our equipment the ultimate in vibration free shots.

New Adapto® collars are made from a single locking component, ensuring better performance and easier maintenance.



BLACK ALU AIR CUSHIONED MINI COMPACT STAND 1051BAC

Aluminium stand, air cushioned. 4 sections, 3 risers.
Ø: 25, 22, 19, 16mm. Leg Ø: 19mm.

- 75cm
- 211cm
- 67cm
- 70cm
- 1kg
- 4kg
- Type 19 + Adapter Art. 015
- 017

BLACK ALU AIR CUSHIONED MINI COMPACT STAND IN 3-PACK 1051BAC-3

Same as 1051BAC, available in 3-pack. Not illustrated



BLACK ALU AIR CUSHIONED COMPACT STAND 1052BAC

Aluminium stand, air cushioned. 3 sections, 2 risers.
Ø: 25, 22, 19mm. Leg Ø: 19mm.

- 101cm
- 237cm
- 86cm
- 109cm
- 1.2kg
- 5kg
- Type 19 + Adapter Art. 015
- 017

BLACK ALU AIR CUSHIONED COMPACT STAND IN 3-PACK 1052BAC-3

Same as 1052BAC, available in 3-pack. Not illustrated



BLACK ALU AIR CUSHIONED MASTER STAND 1004BAC

Aluminium stand, air cushioned. 4 sections, 3 risers.
Ø: 35, 30, 25, 20mm. Leg Ø: 22mm.

- 124cm
- 366cm
- 107cm
- 106cm
- 3kg
- 9kg
- Type 19 + Adapter Art. 015
- 018

BLACK ALU AIR CUSHIONED MINI MASTER STAND IN 3-PACK 1004BAC-3

Same as 1004BAC, available in 3-pack. Not illustrated



BLACK ALU AIR CUSHIONED RANKER STAND 1005BAC

Aluminium stand, air cushioned. 3 sections, 2 risers.
Ø: 35, 30, 25mm. Leg Ø: 22mm.

- 118cm
- 273cm
- 100cm
- 106cm
- 2kg
- 10kg
- Type 25 + Spigot Art. 013
- 018

BLACK ALU AIR CUSHIONED MINI RANKER STAND IN 3-PACK 1005BAC-3

Same as 1005BAC, available in 3-pack. Not illustrated



MINI BACKLITE BASE FEMALE ATTACHMENT 003MF

The hole at the end of each leg enables the user to nail the stand to the floor, hang it on a wall or fix it to the ceiling.

- 8cm
- 40cm
- 0.5kg
- 10kg
- Type 1



MINI BACKLITE BASE MALE ATTACHMENT 003M

Same as 003MF but with 16mm male attachment (Type 22).

- 9.7cm
- 40cm
- 0.52kg
- 10kg
- Type 22



BACKLITE BASE 003

Fold away base.

- 9cm
- 60cm
- 1kg
- 15kg
- Type 1 + Spigot Art.013



With the piling system portability is at the essence! Cling them together and save a lot of room in the studio or carry them in a compact case to easily bring them with you for outdoor shooting. The new baby is now able to stand up on its own even when it's closed.



Junior Lighting stands are medium-high payload stands, suitable for supporting reflectors or luminaires in studio or location. Chrome steel, black zinc and silver or black aluminum versions are available, all with double braced leg base for extra stability and safety. Optional air cushioning as indicated in the product code description (AC).



28mm die cast aluminium socket together with a 16mm stud.



Double braced legs for better stability, resistance and safety.



All versions feature levelling leg for better stability.



All stands in the series can be equipped with wheels either braked wheels.



BLACK ALU STAND 008BU

Black aluminium stand. 2 sections, 1 riser.
 Ø: 35, 30mm. Leg Ø: 22mm. 1 levelling leg.

131cm	212cm	112cm	118cm	4.2kg
15kg	3kg@212cm	Type 14	109, 110, 110G	



STEEL JUNIOR STAND 008CSU

Chrome plated steel stand. 2 sections, 1 riser.
 Ø: 35, 30mm. Leg Ø: 22mm. 1 levelling leg.

132cm	216cm	116cm	118cm	6.4kg
30kg	18kg@216cm	Type 14	110, 110G	



BLACK ALU SENIOR STAND 007BU AC

Aluminium stand. 3 sections, 2 risers.
 Ø: 35, 30, 25mm. Leg Ø: 22mm. 1 levelling leg.

-
-
-
-
-
- 124cm
- 315cm
- 122cm
- 118cm
- 3kg
-
-
-
-
-
- 12kg
- 2.5kg@315cm
- Type 14
- 109, 110, 110G



BLACK STEEL SENIOR STAND 007BSU

Black chrome plated steel stand. 3 sections, 2 risers.
 Ø: 35, 30, 25mm. Leg Ø: 22mm. 1 levelling leg.

-
-
-
-
-
- 124cm
- 325cm
- 122cm
- 118cm
- 7.3kg
-
-
-
-
-
- 20kg
- 6.7kg@325cm
- Type 14
- 109, 110, 110G



STEEL SENIOR STAND 007CSU

Chrome plated steel stand. 3 sections, 2 risers.
 Ø: 35, 30, 25mm. Leg Ø: 22mm. 1 levelling leg.

-
-
-
-
-
- 124cm
- 325cm
- 122cm
- 118cm
- 7.3kg
-
-
-
-
-
- 20kg
- 6.7kg@325cm
- Type 14
- 109, 110, 110G



BLACK STEEL TALL STAND 111BSU

Black chrome plated steel stand. 3 sections, 2 risers.
 Ø: 35, 30, 25mm. Leg Ø: 22mm. 1 levelling leg.
 The small footprint makes this stand perfect for tight spaces.

-
-
-
-
-
- 146cm
- 380cm
- 155cm
- 102cm
- 9kg
-
-
-
-
-
- 25kg
- 6kg@380cm
- Type 14
- 103, 104, 104G



STEEL TALL STAND 111CSU

Chrome plated steel stand. 3 sections, 2 risers.
 Ø: 35, 30, 25mm. Leg Ø: 22mm. 1 levelling leg.
 The small footprint makes this stand perfect for tight spaces.

146cm	380cm	155cm	102cm	9kg
25kg	6kg@380cm	Type 14	103, 104, 104G	



BLACK STEEL HEAVY DUTY STAND 126BSU AC

Chrome plated steel stand. 3 sections, 2 risers.
 Ø: 40, 35, 30mm. Leg Ø: 22mm. 1 levelling leg.

131cm	333cm	131cm	126cm	8.3kg
40kg	3kg@333cm	Type 14	109, 110, 110G	



STEEL HEAVY DUTY STAND 126CSU AC

Chrome plated steel stand. 3 sections, 2 risers.
 Ø: 40, 35, 30mm. Leg Ø: 22mm. 1 levelling leg.

131cm	333cm	131cm	126cm	8.3kg
40kg	3kg@333cm	Type 14	109, 110, 110G	



BLACK ALU SUPER STAND 269BU

Aluminium stand. 4 sections, 3 risers.
 Ø: 50, 45, 40, 35mm. Leg Ø: 30mm. 1 levelling leg.

144cm	455cm	144cm	174cm	8kg
35kg	6.3kg@455cm	Type 14	103, 104, 104G	



BLACK STEEL SUPER STAND 270BSU



Black chrome plated steel stand. 4 sections, 3 risers. Ø: 50, 45, 40, 35mm. Leg Ø: 30mm. 1 levelling leg.
There is a reason we call this the super stand! Incredible reach of 477cm that can support fixtures up to 40kg.

-  144cm
-  477cm
-  144cm
-  174cm
-  13.5kg
-  40kg
-  12kg@477cm
-  Type 14
-  103, 104, 104G



STEEL SUPER STAND 270CSU

Chrome plated steel stand. 4 sections, 3 risers.
Ø: 50, 45, 40, 35mm. Leg Ø: 30mm. 1 levelling leg.

-  144cm
-  477cm
-  144cm
-  174cm
-  13.5kg
-  40kg
-  12kg@477cm
-  Type 14
-  103, 104, 104G



BLACK ALU HIGH SUPER STAND 269HDBU

Aluminium stand. 6 sections, 5 risers.
 Ø: 50, 45, 40, 35, 30, 25mm. Leg Ø: 30mm. 1 levelling leg.

-  190cm
-  730cm
-  173cm
-  174cm
-  10kg
-  10kg
-  1kg@730cm
-  Type 14
-  103, 104, 104G



BLACK ALU STAND EXTENSION 142B

2 section (Ø 35, 30mm) black aluminium extension.
 Minimum height: 125cm. Maximum height: 210cm.

-  2.4kg
-  Top type 14
-  Bottom type 37



STEEL HIGH STAND EXTENSION 146CS

3 section (Ø 35, 30, 25mm) chrome steel extension.
 Minimum height: 137cm. Maximum height: 314cm.

-  4.8kg
-  Top type 14
-  Bottom type 37



STEEL STAND EXTENSION 142CS

2 section (Ø 35, 30mm) chrome steel extension.
 Minimum height: 125cm. Maximum height: 210cm.

-  3.6kg
-  Top type 14
-  Bottom type 37



BLACK ALU HIGH STAND EXTENSION 146B

3 section (Ø 35, 30, 25mm) black aluminium extension.
 Minimum height: 137cm. Maximum height: 314cm.

-  2.8kg
-  Top type 14
-  Bottom type 37

Roller stands are characterized by low profile bases that slip easily into position on set. All models are supplied with free running wheels and positive brakes.



Quick action folding legs.



Low profile or an easier and quicker positioning of light fixtures.











Levelling leg.



STEEL COLUMN STAND 231CS

Chrome plated steel post: Ø: 35mm.
Height of light fixture: from ground level to 250cm.
Complete with braked wheels. 1 levelling leg.

-  35cm
-  250cm
-  121cm
-  100cm
-  8kg
-  8kg
-  5kg@250cm
-  Type 1
+ Spigot Art. 013







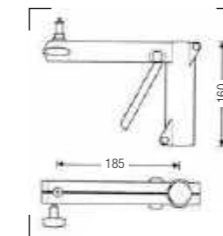



SLIDING SUPPORT ARM 231ARM

Quick release arm, used to mount standard 16mm light fixtures, attachments 16mm female and Spigot 013 (16mm male and 1/4" - 3/8" screws).



BLACK ALU COLUMN STAND 231B

Black aluminium post: Ø: 35mm.
Height of light fixture: from ground level to 250cm.
Complete with braked wheels. 1 levelling leg.

-  35cm
-  250cm
-  121cm
-  100cm
-  6.4kg
-  8kg
-  2kg@250cm
-  Type 1
+ Spigot Art. 013



BLACK BABY STUDIO STAND 299B

Black steel base, silver anodised aluminium sections, complete with wheels.
3 sections, 2 risers. Ø: 35, 30, 25mm. 1 levelling leg.

108cm	272cm	105cm	75cm	4.8kg
12kg	2.2kg@272cm	Type 3 + Spigot Art. 013		



BLACK ALU STUDIO STAND 298B

Black steel base, silver anodised aluminium sections, complete with wheels.
3 sections, 2 risers. Ø: 35, 30, 25mm. 1 levelling leg.

129cm	300cm	125cm	100cm	6kg
15kg	5kg@300cm	Type 14		



BLACK LARGE BRAKE BASE 297BBASE

1 levelling leg.
Complete with braked wheels.

28cm	52cm	100cm	5.7kg
40kg	Type 14		



BLACK LARGE FOOT BASE 297FBASE

1 levelling leg.
Complete with feet.

21cm	52cm	100cm	4.4kg
40kg	Type 14		



BLACK SMALL BRAKE BASE 299BBASE

1 levelling leg.
Complete with braked wheels.

28cm	36cm	75cm	4.8kg
40kg	Type 14		



BLACK SMALL FOOT BASE 299FBASE

1 levelling leg.
Complete with feet.

21cm	36cm	75cm	3.5kg
40kg	Type 14		

Mighty stands that reach high height. Made by chrome or stainless steel, single and double risers which extend simultaneously. Levelling leg for easy positioning and double braces leg base for extra stability and safety.



Cable transmission is fully inside sections.

Third internal safety cable.

"Safe finger" protection.



Bolts: all wind up stands assembled using bolts instead of rivets for easier maintenance.



Fold away crank handle for avoiding split up during usage and reducing protrusion during storage.



Double braced legs for better stability, resistance and safety.



All versions feature levelling leg for better stability.



All stands in the series can be equipped with wheels either braked wheels.



Aluminium feet for improved stability and longer durability.



STEEL 3 SECTION LOW BASE WIND UP STAND 087NWL B

Geared centrepost steel stand. 3 sections, 2 risers. Ø: 55, 45, 38mm. 1 levelling leg. Fitted with braked wheels.

144cm	276cm	134cm	100cm	16kg
30kg	5.5kg@276cm	Type 14		



STEEL 2 SECTION LOW BASE WIND UP STAND 083NWL B

Geared centrepost steel stand. 2 sections, 1 riser. Ø: 55, 45mm. 1 levelling leg. Fitted with braked wheels.

129cm	190cm	112cm	100cm	11kg
35kg	2.5kg@190cm	Type 14		



STEEL WIND UP STAND 087NW

Chrome steel stand with geared column.
2 risers extend simultaneously at an elevation of 4.4cm per handle turn.
Safety cable ensures simultaneous retrieval of all sections.
3 sections, 2 risers. Ø: 55, 45, 38mm. Leg Ø: 30mm. 1 levelling leg.

- 167cm
- 370cm
- 181cm
- 128cm
- 21.4kg
- 30kg
- 30kg@370cm
- Type 14 104, 104G, 374-10



BLACK STEEL WIND UP STAND 087NWB

Black chrome steel stand with geared column.
2 risers extend simultaneously at an elevation of 4.4cm per handle turn.
Safety cable ensures simultaneous retrieval of all sections.
3 sections, 2 risers. Ø: 55, 45, 38mm. Leg Ø: 30mm. 1 levelling leg.

- 167cm
- 370cm
- 181cm
- 128cm
- 21.4kg
- 30kg
- 30kg@370cm
- Type 14 104, 104G, 374-10



STEEL SHORT WIND UP STAND 087NWSH

Short version of 087NW. 3 sections, 2 risers.
Ø: 55, 45, 38mm. Leg Ø: 30mm. 1 levelling leg.

- 135cm
- 276cm
- 155cm
- 128cm
- 15.5kg
- 30kg
- 15kg@276cm
- Type 14 104, 104G, 374-10

STEEL 2 SECTION WIND UP STAND 083NW



Chrome steel stand with geared column. Elevation: 2.2cm per handle turn.
2 sections, 1 riser. Ø: 55, 45mm. Leg Ø: 30mm. 1 levelling leg.

- 139cm
- 247cm
- 153cm
- 128cm
- 16kg
- 45kg
- 30kg@247cm
- Type 14 104, 104G, 374-10



STAINLESS STEEL SUPER WIND UP STAND 387XU









Heavy lift stand with strengthened stainless steel column and legs, chrome steel risers and geared column.
 3 sections Ø: 70, 60, 50mm.
 2 risers which extended simultaneously at 4.4cm per handle turn.
 Safety cable ensures simultaneous retrieval of all sections.
 Rapid adjustment. Leg Ø 35mm. 1 levelling leg.
 PATENTED

-  156cm
-  366cm
-  179cm
-  180cm
-  32.5kg
-  80kg
-  80kg@366cm
-  28mm
-  374



BLACK STAINLESS STEEL SUPER WIND UP STAND 387XBU

Heavy lift stand with strengthened stainless steel column and legs, black chrome steel risers and geared column.
 3 sections Ø: 70, 60, 50mm.
 2 risers which extended simultaneously at 4.4cm per handle turn.
 Safety cable ensures simultaneous retrieval of all sections.
 Rapid adjustment. Leg Ø 35mm. 1 levelling leg.
 PATENTED

-  156cm
-  366cm
-  179cm
-  180cm
-  32.5kg
-  80kg
-  80kg@366cm
-  28mm
-  374



All Manfrotto stands provide for a high level of customisation, thanks to a wide range of accessories like wheels, sand bags, clips, wind-bracing kit and stans holder that can accept any lighting fixture, in order to match any requirement.



THREE BABY BRACKET 154B



65cm long T Bar with 3 x 16mm sockets plus 3 x 16mm Spigot Art. 013. Designed to fit on stand or bracket with 16mm pin.

-  0.79kg
-  28mm
-  16mm + Spigot Art. 013



EXPAN ATTACHMENT 081

Another quick solution to hang your expan up to a baby stand.

-  0,204kg
-  Type 1



WIND-BRACING KIT 087WBK

Wind-bracing kit of 3 ropes. Length: 10m. Not supplied with the stand.



STAND HOLDER 027

Holder for 8 light stands. Width: 115cm. Distance between fixing holes: 64.4cm. Depth: 19cm.

-  2.8kg



T BAR 614

4 x Lantern T Bar 1220mm long.



T BAR 613PAR

"T" Bar specifically design to carry six PAR 57 or 64 luminaires. Supplied with a built in TV male spigot. Max load capacity: 6kg on each attachments, only at the ends 12kg on each side.



SMALL SAND BAG G100-2

(Sand not supplied)

-  6kg



EXTRA LARGE SAND BAG G300

(Sand not supplied)

-  35kg

LARGE SAND BAG G200-1

(Sand not supplied)

-  10kg



SMALL CABLE CLIP 064

Clamps on Ø: 18mm to 26mm. Allen key not supplied. Set of four.



0.02kg



LARGE CABLE CLIP 093

Clamps on Ø: 28mm to 40mm. Allen key not supplied. Set of four.



0.03kg



CASTER WHEEL SET 017

Caster wheel set for stands with legs Ø: 19mm. Set of three.



0.45kg 10kg



CASTER WHEEL SET 018

Caster wheel set for stands with legs Ø: 22mm. Set of three.



0.45kg 10kg



WHEEL SET 104

Ø: 75mm with brakes and M10 attachment. Set of three.



1.5kg 75kg



WHEEL SET 109

Ø: 80mm without brakes and adapter for legs Ø: 22mm. Set of three.



1.43kg 60kg



WHEEL SET 110

Ø: 75mm with brakes and adapter for legs Ø: 22mm. Set of three.



1.7kg 75kg



WHEEL SET 104G

Ø: 100mm with brakes and M10 attachment. Set of three.



3kg 100kg



WHEEL SET 110G

Ø: 100mm with brakes and adapter for legs Ø: 22mm. Set of three.



3.2kg 100kg



WHEELS FOR SUPER WIND UP 374

Ø: 160mm with brakes. Set of three.



7.2kg 300kg

WHEELS FOR SUPER WIND UP 374-10

Not illustrated

Ø: 160mm with brakes and M10 attachment. Set of three.



7.2kg 300kg

Lighting booms and boom stands provide the idea unobtrusive way to position lighting and reflector equipment directly above the subject. Boom stands are the perfect answer to those who need the flexibility of a boom and a lighting stand in one unit. Available in lightweight aluminum and steel for any type of shoot. Using a special articulated joint, which work both as a locking collar and as a pivoting boom clamp, all Manfrotto upright boom stands can rapidly be converted into stands with horizontal boom arms.

Sandbag counterweight available.



5/8" top fixing with 3/8" screw fixing (adjustable 90°) and 1/4" adapter for matching any requirement.



A special articulated coupler allows this model to be used either as a normal stand or boom.

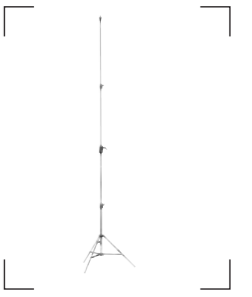
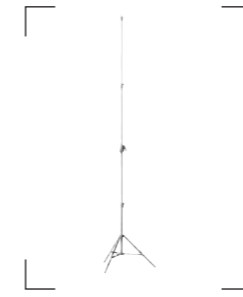

BLACK ALU COMBI-BOOM STAND WITH SANDBAG 420B

Aluminium stand. Supplied with sandbag counterweight (empty) for maximum stability and smoothness.
 4 sections, 3 risers. Ø: 35, 30, 25, 20mm. Leg Ø: 22mm.
 Minimum extension boom: 19cm
 Maximum extension boom: 191cm
 Maximum load at boom full extension: 2kg with counterweight.

- 131cm
- 392cm
- 113cm
- 109cm
- 2.7kg
- 9kg
- 0.9kg@392cm
- 018
- Type 25 + Spigot Art. 013

COMBI-BOOM STAND HD 420CSU

Same as 420B but with legs and column in steel, last two sections in aluminium.
 Maximum load at boom full extension: 5kg with 35kg of counterweight.

- 131cm
- 392cm
- 113cm
- 109cm
- 5.6kg
- 12kg
- 1.5kg@392cm
- 018
- Type 25 + Spigot Art. 013



BLACK MEGA BOOM (STAND NOT INCLUDED) 425B

Largest boom in the range, remote control of pan, tilt and rotation of laminar plus geared telescopic extension. Combination of black zinc steel and black anodised aluminium tubes. Supplied with sandbag.
 2 sections (Ø: 45, 55mm).
 Folded length: 220cm.
 Minimum extension from stand attachment: 50cm.
 Maximum extension from stand attachment: 320cm.
 * Load: 6kg at maximum extension with 30kg of counterweight.
 30kg at minimum extension with 30kg of counterweight.

Suggested stands: Wind Up series.

-  15kg
-  6kg-30kg*
-  GC
-  16mm/28mm
-  28mm stand attachment



Product in use



BLACK LIGHT BOOM 35 (STAND NOT INCLUDED) 085BSL

Ø 35mm. 3 section boom arm complete with Pivoting Clamp 123, counterweight G-Peso 022, cable clips and locking key.
 Weight: 2.2kg, boom only.
 Dismantled length: 100cm.
 Assembled length: 280cm.
 Minimum extension from stand attachment: 10cm.
 Maximum extension from stand attachment: 250cm.
 Load: 6kg at maximum extension with 7kg of counterweight.

-  2.2kg
-  6kg
-  Type 25 + Spigot Art. 013
-  28mm stand attachment

BLACK LIGHT BOOM 35 (STAND INCLUDED) 085BS

Not illustrated

Ø 35mm 3 sections boom arm complete with Pivoting Clamp 123, counterweight G-Peso 022, Cine Stand with casters, cable clips and locking key.
 Weight: 2.2kg, boom only.
 Dismantled length: 100cm.
 Assembled length: 280cm.
 Minimum extension from stand attachment: 10cm.
 Maximum extension from stand attachment: 250cm.
 Load: 6kg at maximum extension with 7kg of counterweight.

-  16.4kg
-  6kg
-  Type 25 + Spigot Art.013
-  28mm stand attachment



Product in use





BLACK SUPER BOOM (STAND NOT INCLUDED) 025BSL

Ø 35mm. 1 section boom complete with Pivoting Clamp 123, counterweight G-Peso 022, cable clips.
 Weight: 4.1kg, boom only.
 Remote control of lighting movement: 270cm long.
 Minimum extension from stand attachment: 24cm.
 Maximum extension from stand attachment: 100cm.
 Load: 5kg at maximum extension with 7kg of counterweight.

-  4.1kg
-  5kg
-  Type 17 + Rapidapter Art. 014-38
-  28mm stand attachment

BLACK SUPER BOOM (STAND INCLUDED) 025BS Not illustrated

Ø 35mm 1 section boom arm complete with Pivoting Clamp 123, counterweight G-Peso 022, Cable Clips and Cine Stand 008 with casters.
 Weight: 4.1kg, boom only.
 Remote control of lighting movement: 270cm long.
 Minimum extension from stand attachment: 24cm.
 Maximum extension from stand attachment: 100cm.
 Load: 5kg at maximum extension with 7kg of counterweight.

-  21kg
-  5kg
-  Type 25 + Rapidapter Art. 014-38
-  28mm stand attachment







Product in use



BLACK LIGHT BOOM (STAND NOT INCLUDED) 024B

Boom attaches to the shaft of most lightstands with diameters of 19, 20, 25, 28mm.
 Ø: 25mm 3 section boom arm complete with Pivoting Clamp 124, counterweight G-Peso 023, cable clips and locking key.
 Weight: 1.4kg, boom only.
 Dismantled length: 71cm.
 Assembled length: 200cm.
 Minimum extension from stand attachment: 120cm.
 Maximum extension from stand attachment: 210cm.
 Load: 3kg at maximum extension with 4.5kg of counterweight.

-  1.4kg
-  3kg
-  5/8" (16mm) Spigot
-  5/8" (16mm) Receiver
-  Type 25 + Spigot Art. 013



Product in use



SUPER BOOM WITH COLUMN STAND 025TM

Ø 35mm. 1 section boom arm complete with Pivoting Clamp 123, counterweight G-Peso 022, Cable Clips and Column Stand with casters.
 Weight: 4.1kg, boom only.
 Remote control of lighting movement: 140cm long.
 Minimum extension from stand attachment: 10cm.
 Maximum extension from stand attachment: 108cm.
 Load: 5kg at maximum extension with 7kg of counterweight.

-  18.5kg
-  5kg
-  Type 17+ Rapidapter Art. 014-38
-  28mm stand attachment



Product in use



BLACK WALL BOOM (STAND NOT INCLUDED) 098B

Wall mounted boom arm. 2 sections (Ø 35, 29mm).
 Rotation: 160° vertically and 180° horizontally.
 Minimum extension from stand attachment: 120cm.
 Maximum extension from stand attachment: 210cm.
 Load: 4.5kg at maximum extension.

-  2.3kg
-  4.5kg
-  Type 15 + Spigot Art. 013



BLACK SHORT WALL BOOM (STAND NOT INCLUDED) 098SHB

Minimum extension from stand attachment: 78cm.
 Maximum extension from stand attachment: 12cm.

-  2kg
-  5kg
-  Type 25 + Spigot Art. 013



BLACK MINI BOOM 173B

Boom shaft Ø: 20mm. Length: 109cm.



0.32kg Type 18 and Type 19



PIVOTING BOOM CLAMP 123

Pivoting clamp for Ø 35mm boom shaft Ø 28mm male and Ø 16mm attachment.



0.72kg



PIVOTING BOOM CLAMP 124

Pivoting clamp for Ø: 19, 20, 25 and 28mm boom shafts (or any tubes of these diameters).



0.67kg



G-PESO 022

Counterweight. Clamps on Ø 22mm to 35mm.



6.7kg



MINI COUNTERWEIGHT 172

Clamps on bars from Ø 13mm to 30mm.



1,3kg

L-PESO 023

Not illustrated



4.3kg



EXTRA LARGE SAND BAG G300

(Sand not supplied)



35kg



SMALL SAND BAG G100-2

(Sand not supplied)



6kg

LARGE SAND BAG G200-1

(Sand not supplied)



10kg

Autopole® System

The ultimate adjustable lighting pole system can be used to create a background support, structure a lighting grid, or for hundreds of other studio and outdoor applications. Its unique single action cantilever locking system exerts the correct amount of pressure to assure a secure fit, wedging the protective rubber ends in place, ceiling to floor. The cantilever system incorporates a safety lock to prevent accidental de-tensioning or movement.

Unique cantilever single action locking system exerts pressure to securely wedge the rubber suction cup ends in place. Cantilever system incorporates safety lock. Floor to ceiling, or wall to wall fixing for strong vertical or horizontal support of lighting.

Loading limits

The following figures are valid for use with rigid floors and ceilings, and with the protection-cups mounted on the suction-cups.

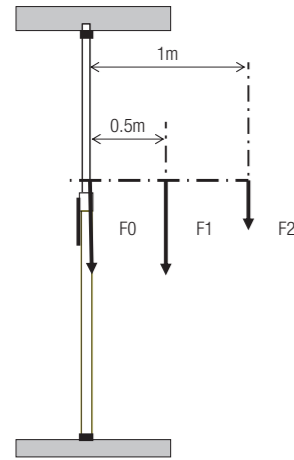

MODELS	Load (kg)		
	F0	F1	F2
032	30	30	15
076	30	30	15
077	30	30	15
432-2.7	24	24	12
432-3.7	24	24	12

F0: maximum axial load - F1: maximum load with 0.5m arm - F2: maximum load with 1m arm

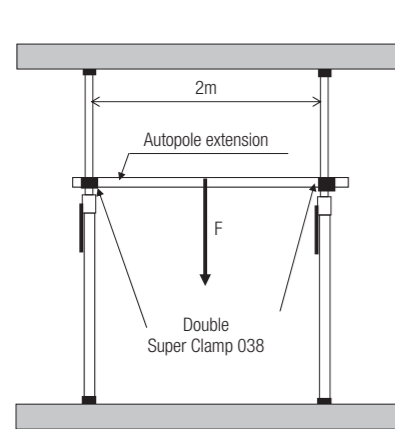

MODELS	Load (kg)
	F
032	20
076	20
077	20
432-2.7	20
432-3.7	20



077

076

032

432-2.7

432-3.7

332-3.7

AUTOPOLE 077 B

Extends from 100cm to 170cm. Pole Ø: 45mm and 40mm.



1.5kg

AUTOPOLE 076 B

Extends from 150cm to 270cm. Pole Ø: 45mm and 40mm.



1.83kg

AUTOPOLE 032 B

Extends from 210cm to 370cm. Pole Ø: 45mm and 40mm.



2.2kg

AUTOPOLE 2 432-2.7 B

Two position variable thrust. Extends from 150cm to 270cm. Pole Ø: 45mm and 40mm. PATENTED



2.23kg

AUTOPOLE 2 432-3.7 B

Two position variable thrust. Extends from 210cm to 370cm. Pole Ø: 45mm and 40mm. PATENTED



2.6kg

MINI AUTOPOLE 332-3.7B

Extends from 210cm to 370cm. Pole Ø: 35mm and 32mm.



1.38kg



AUTOPOLE BASE 032BASE B

For tubes: Ø 45mm. Legs Ø: 22mm.



86cm



126cm



1.2kg



AUTOPOLE SPIRIT LEVEL 032SPL

Spirit level for use on Autopole®, or on tubes of 25mm to 60mm diameter.



AUTOPOLE PROTECTION CAPS 032PC

Set of four protection caps for rubber feet with inner hole. Ø: 16.5mm. Suitable for use with all Autopoles except Midi Autopole® 332 and Mini Pole 170.

EXTENSION TUBE 034 B

Autopole® Extension tube. Ø: 40mm. Length: 1,5m. Suitable for Autopole2® and Autopole®.



0.53kg

EXTENSION TUBE 033 B

Autopole® Extension tube. Ø: 40mm. Length: 2m. Suitable for Autopole2® and Autopole®.



0.69kg

MINI POLE 170 B

Spring loaded mini pole. Extends from 175cm to 330cm. Post Ø: 25mm and 28mm.



0.87kg



034

033

170

TetherGear



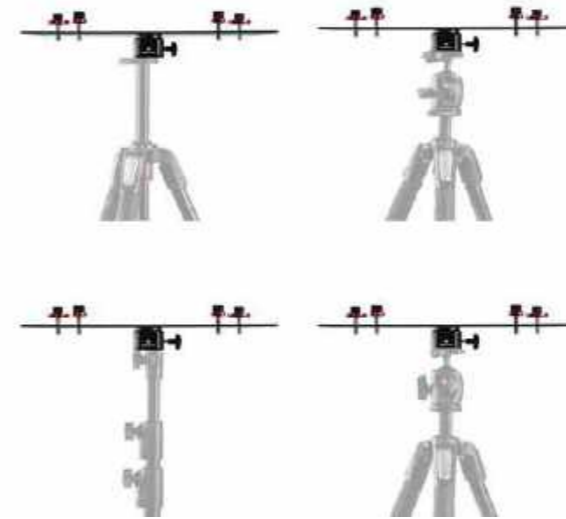
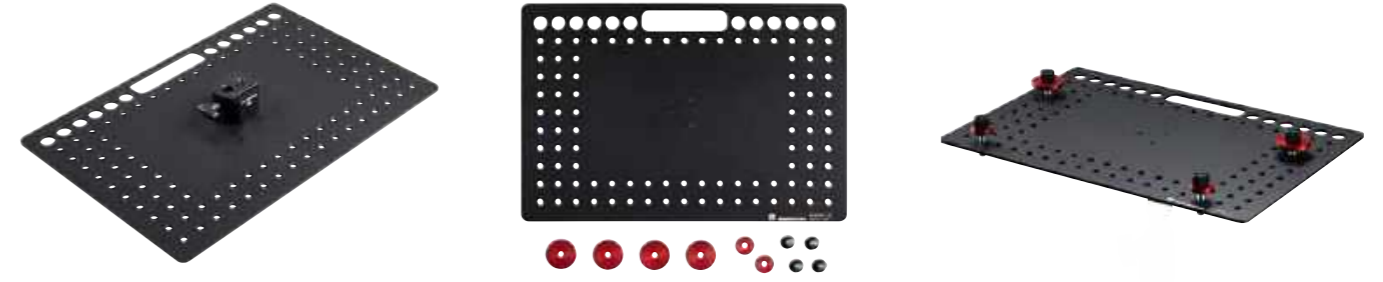

TETHERGEAR MLTSA4301B

Supports laptops up to 46 cm x 31 cm (16.14" x 12.20").
 Multiple mounting options: Light stands, Tripods, Friction Arms.
 Cheese plate style 3/8" threaded holes.
 Includes anti-slip mounting hardware for safe and secure hold.
 Built in cable management.
 Length 46cm, width 31cm, Height 4.8cm.

-  2.36kg
-  3/8"
-  1/4", 3/8", 5/8" (16mm) socket



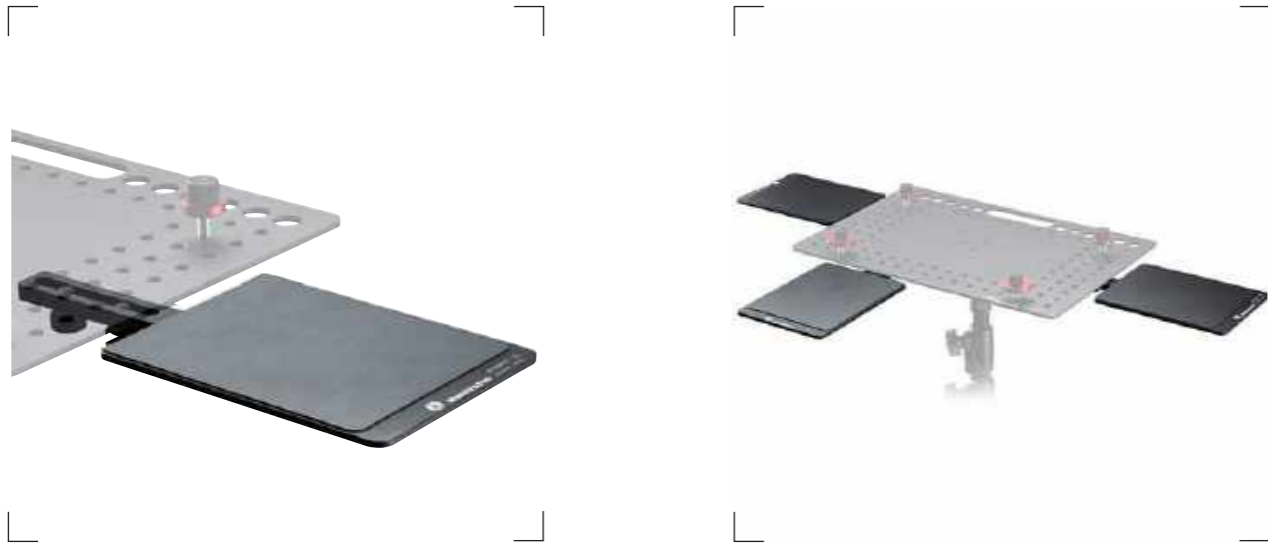

TETHERGEAR MOUSE DECK **MLTSA2001B**

Designed for the TetherGear Laptop Deck.
Provides a solid support for an external mouse or track pad.
Use in left- or right-hand configuration in multiple positions.
Infrared mouse compatible neoprene pad.
Adjustable sliding arm for reach adjustment.
Length 32cm, width 15cm, Height 2.5cm.

 0.52kg
 3/8"



TETHERGEAR TABLET HOLDER 9"-13" **MLTSA3301**

Multiple mounting points
Adjustable dimensions to fit multiple tablet sizes
Supports tablets between 9" - 13"
Soft rubber grip and corners ensure a secure fixing
Ergonomic knob for quick adjustment
Length 26.5cm, width 6.5cm, Height 4.3cm.

 0.44kg
 1/4",
3/8" with AR





TETHERGEAR VESA MONITOR MOUNT **MLTSA1001B**

75x75mm and a 100x100mm VESA compatibility.
 Multiple accessory mounting points.
 Mount screens horizontally or vertically.
 Folds flat against screen for transport.
 Up to a 30kg (66.13 lbs) payload.
 Length 18.5cm, width 12.5cm, Height 5cm.

-  0.7kg
-  3/8" with AR,
5/8" (16mm) socket
-  30kg

Included mounting screws 4x M4x16

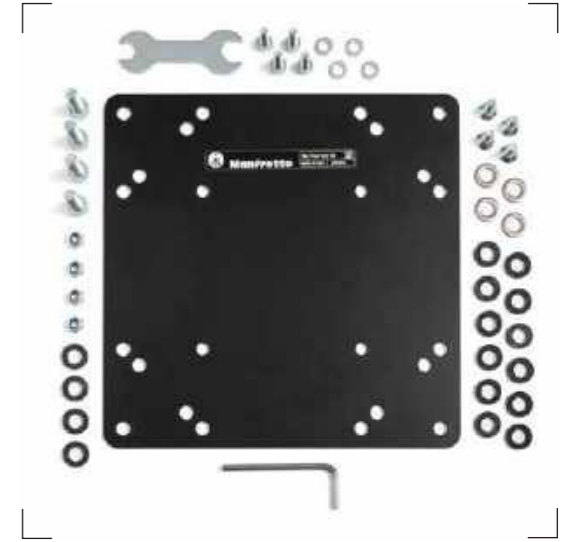

TETHERGEAR VESA ADAPTER PLATE **MLTSA1201B**

Designed for the TetherGear VESA Mount.
 Support monitors with VESA hole configuration up to 200 x 200.
 Up to a 30kg (66.13 lbs) payload.
 Includes fixing kit.
 Steel plate with black finish.
 Length 22.5cm, width 22.5cm, Height 0.3cm, depth 0.3cm.

-  1.31kg
-  1/4",
3/8" with AR

Included mounting screws 4x M6x16 and 4x M8x25

Clamps



Manfrotto offers several families of clamps to position lights and accessories practically anywhere. The original and world famous Super Clamp stands out for its versatility and numerous accessories. The entire range of clamps (spring clamps, pipe clamps, nano clamps, small size clamps) ensures a solution to any problem, regardless the size of the object and the surface you are clamping to.



Vice Jaw Clamps

The Vice Jaw Clamp line up is made up of four different variants tailored to help solve endless challenges on set; two end jaw clamps, a micro end jaw clamp and a centre jaw clamp.

All four Vice Jaw Clamps feature three unique features that make them the very best of their kind available. A specially developed M-Grip material that is mechanically bonded to the jaws will give years of reliable grip without requiring replacement. With safety at the forefront of design all four Vice Jaw Clamps feature the highest load ratings in their class, together with an innovative Anti-Jam Collar that helps reduce the occurrence of jaws locking together in both use and storage.



6" END VICE JAW CLAMP C152EJ

Heavy duty end jaw clamp with 6" / 15cm opening capacity and 110lbs / 50kg maximum payload. Featuring a fixed jaw at the end of the threaded rod, ideal for positioning in tight spaces and a 5/8" / 16mm baby pin for compatibility with industry standard fixtures.



0.7kg 5/8" / 16mm Baby Pin 110lbs / 50kg



2" END VICE JAW CLAMP C50EJ

Heavy duty end jaw clamp with 2" / 5cm opening capacity and 110lbs / 50kg maximum payload. Featuring a fixed jaw at the end of the threaded rod, ideal for positioning in tight spaces and a 5/8" / 16mm baby pin for compatibility with industry standard lighting fixtures.



0.57kg 5/8" / 16mm Baby Pin 110lbs / 50kg



3" CENTRE VICE JAW CLAMP C76CJ

Heavy Duty Centre Jaw Clamp with a 3" / 7.5cm opening capacity and 176lbs / 80kg maximum payload. Featuring a fixed jaw mounted at the base of the 16mm / 5/8" baby pin to provide secure mounting of heavier lighting fixtures

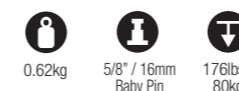

0.62kg 5/8" / 16mm Baby Pin 176lbs / 80kg

2" MICRO END VICE JAW CLAMP C50MEJ

Micro End Jaw Clamp with 2" / 5cm opening capacity and 55lbs / 25kg maximum payload. Featuring a fixed jaw at the end of the threaded rod, ideal for positioning in tight spaces and a 1/4" female thread and 1/4" to 1/4" male adaptor for light duty grip applications. The knurled shaft makes it ideal for mounting in a C-stand grip head for gripping objects such as light controls or props.



0.19kg 1/4" Female Thread 1/4" to 1/4" male adaptor 55lbs / 25kg



Wide choice of spring clamps and grips covers a huge range of applications. Constructed of aluminium or sheet steel, the clamps have thousands of uses, from supporting lights to clamping backgrounds to crossbars.

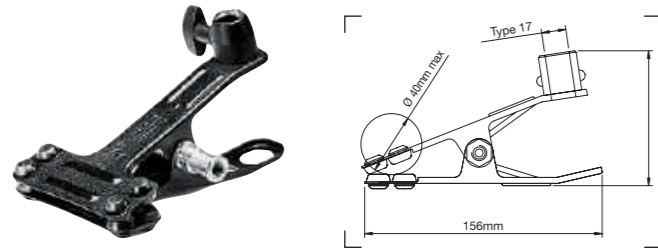

COLD SHOE SPRING CLAMP 175

Clamps onto bars up to Ø 40mm.

- 0.32kg
- Type 1
- Type 1

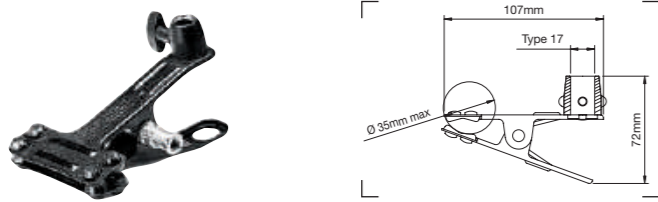

MINI SPRING CLAMP 275

Clamps onto bars up to Ø 35mm. It can be mounted also on 16mm extension arms.

- 0.11kg
- Type 1
- Type 17

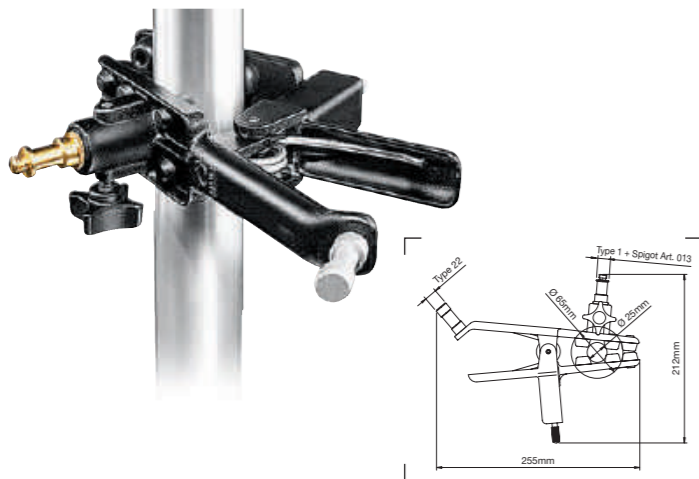

SKY HOOK 043

Gaffer grip with adjustable jaws. Grip from: 25mm to 65mm.

- 0.65kg
- Type 22
- Type 17 + Spigot Art. 013

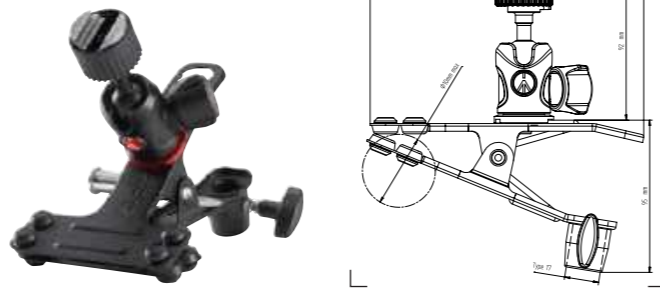

SPRING CLAMP WITH FLASH SHOE 175F-2

Clamps onto bars up to Ø 40mm. Supplied with a position able miniature ball head with a flash shoe attachment to allow it to clip and position a flash unit wherever it is needed.

- 0.33kg
- Type 1
- Type 17
- 2kg



MULTICLIP 375

This versatile double clip can be used to hold gels in front of lights or small reflecting panels.

- 0.08kg

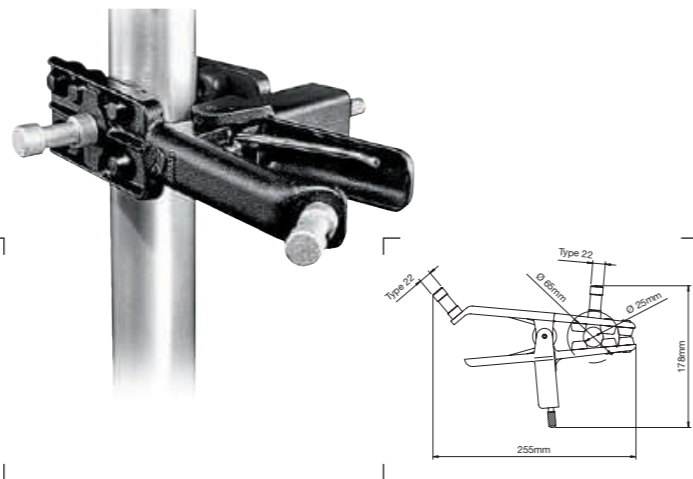

SKY HOOK C1525

Gaffer grip with adjustable jaws. Grip from: 25mm to 65mm.

- 0.8kg
- Type 22

Manfrotto Pipe Clamps are made from aluminium alloy or rugged gravity cast aluminium for extra strength.

Clamping range encompasses pipes from 28mm to 78mm diameter. All standard luminaire attachments available, from 16/28mm bushing to 16mm pins and 1/4" - 3/8" - M10 and M12 male thread.

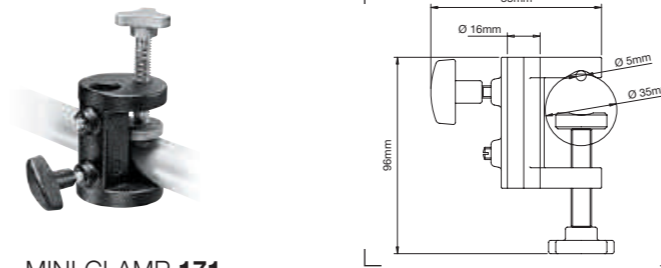

MINI CLAMP 171

Clamps on bars up to Ø 35mm.

- 0.16kg
- 16mm

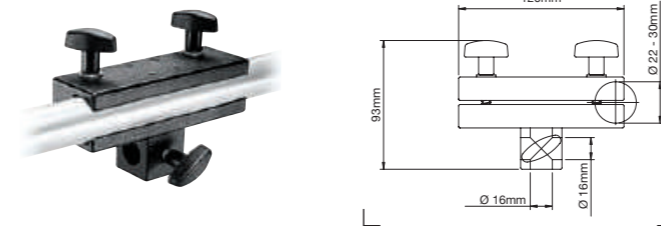

PANEL CLAMP 271

Clamps onto round and square tubes from Ø 22mm to 30mm. Ideal for supporting reflector panels or hanging objects from pipes.

- 0.29kg
- 16mm

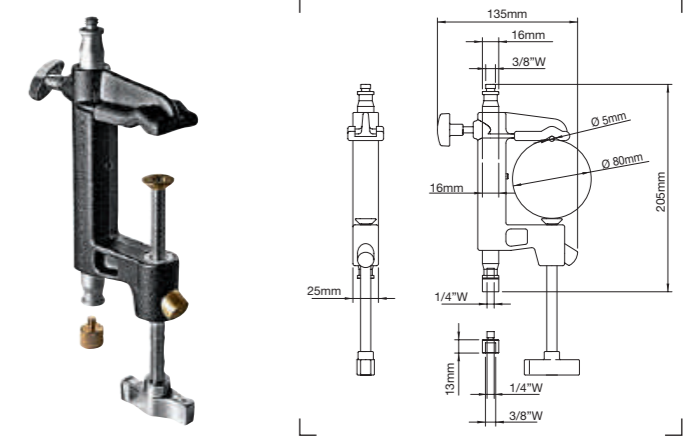

QUICK RELEASE CLAMP 649

Different from the other versions that are used mainly on round pipes, this version will also work on square and rectangular tubes. Extremely light, with a good "coupling range", this version also offers an incredible number of attachment sizes. Ideal for photographic applications and dedicated accessories. Pipe size 5-80mm. PATENTED

- 0.57kg
- 16mm
- 7kg

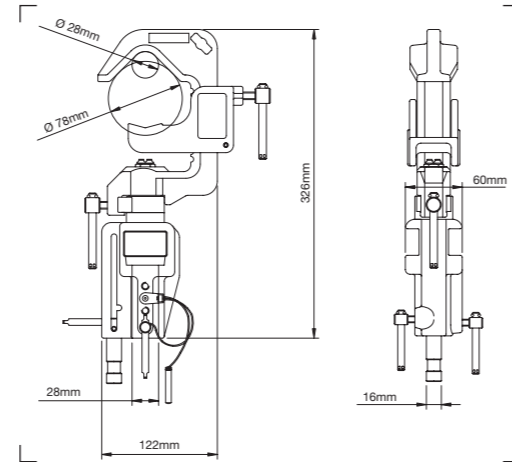

SWIVELLING "C" CLAMP C150

Works on diameters from 28mm to 78mm.
 * 10kg on 16mm attachment. 75kg on 28mm attachment.

- 1.6kg
- 10/75kg*
- 28 mm
-

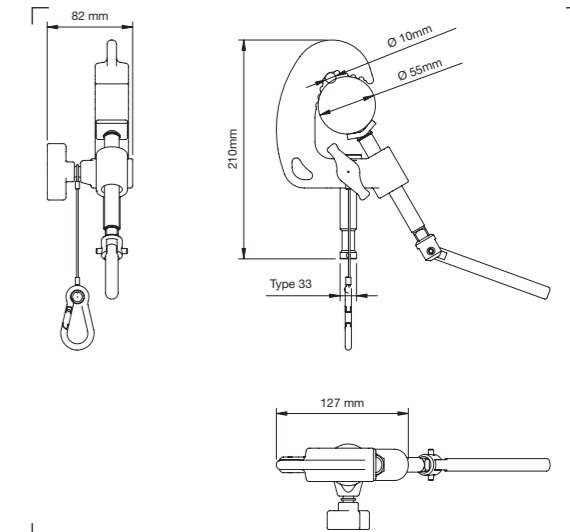

BABY PIPE CLAMP WITH 16MM STUD C210

Works on diameters from 10mm to 55mm.

- 0.62kg
- 100kg
- Type 33
-

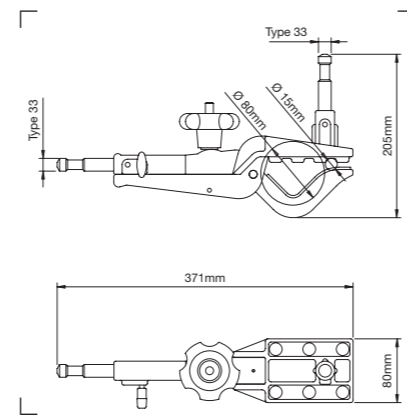

PELICAN GAFFER GRIP C500

Works on diameters from 15mm to 80mm.

- 1.4kg
- 10kg
- Type 22
- Type 33
-

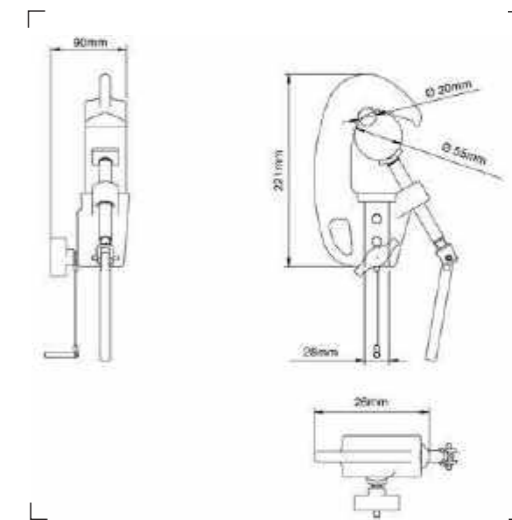

JUNIOR PIPE CLAMP WITH 28MM SOCKET C100

Works on diameters from 20mm to 55mm.

- 1.13kg
- 250kg
- 28mm
-

Manfrotto Super Clamp is the most versatile single piece of light grip gear. Frictionlined screw-operated jaws grip everything from 13mm to 55mm. Hexagonal socket with unique secondary safety lock system holds items in place even if the screw lock comes undone. Supplied with a wedge to square off the jaws for mounting to flat surfaces. This masterpiece of practicality and solidity is the most widely copied clamp in the world! Manfrotto Nano Clamp and Pico Clamp are the natural extension of the range; small but robust, they represent the ideal solution to grip loads to bars with diameter down to 8mm.



SUPER CLAMP 035

Ideal clamp for photographic application. Ergonomic lever to securely lock clamping position.

- 0.41kg
- 15kg



DOUBLE SUPER CLAMP 038

Set of two Super Clamps fastened together at fixed right angle to provide extra strength support for tubes or bars.

- 0.83kg



PICO CLAMP MC1990A

Manfrotto "Pico Clamp" is an extra-small clamp with versatile use. It offers the possibility to safely attach the equipment to very thin bars, having a diameter from 8 to 15 mm.

- 0.07kg
- 2kg
- 1/4" - 3/8" attachment type

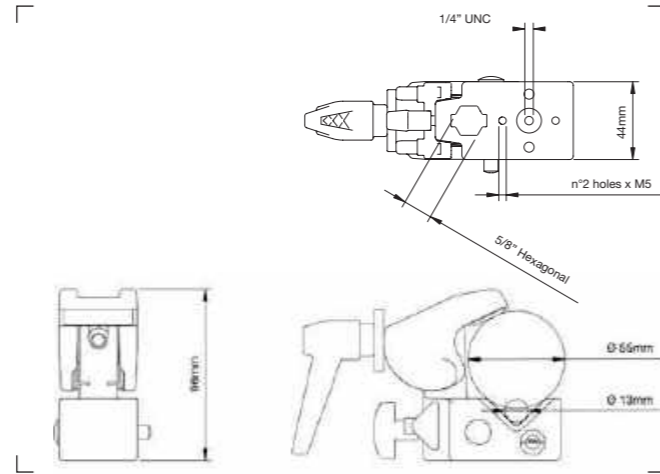

QUICK ACTION SUPER CLAMP 635

The rapid action locking jaw has also been applied to the most well known clamp in the world, the original Super Clamp. These modifications allow us to keep its extreme versatility adding unrivaled speed in locking and unlocking. Supplied with wedge to allow the clamp to fit on flat surface.



- 0.47kg
- 15kg
- 16mm hexagonal + M5 & 1/4" threads

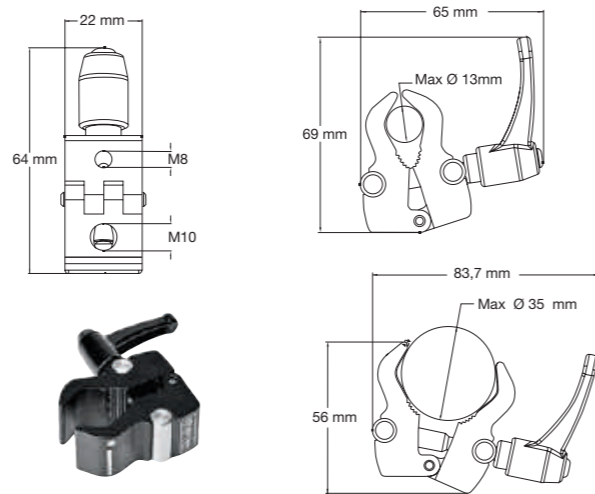

NANO CLAMP 386B-1

Its the new Manfrotto small size clamp. Its reduced size is the most important plus: the Nano Clamp is 4kg of payload in 110 grams of weight and the right size for any pocket.

- 0.25kg
- 4kg



SPIGOT ADAPTER 013

Universal 16mm spigot with double male thread 1/4" and 3/8".

- 0.07kg



LIGHTING STUD 3/8" 036-38

Plugs into Super Clamp 035 for lighting fixtures or connecting 2 Super Clamps 035 allowing them to rotate. 16mm stud with 3/8" male threads.

- 0.07kg



JOINING STUD 061

Connects 2 Super Clamp 035 with 6 step fixed rotation.

- 0.025kg



ROUNDED 16MM LIGHTING STUD M10 264

Rounded stud for stirrup's fixture for a rapid onnection to a Super Clamp.

- 0.072kg



EXTENSION BAR 133B

Used to fix 2 Super Clamps 035 at a distance of 15cm from each other. Length 16.5cm.

- 0.1kg



SHORT 16MM SPIGOT WITH 1/4" + 3/8" SCREW 118

Universal short 16mm spigot with double male thread 1/4" and 3/8".

- 0.04kg



LIGHTING STUD 1/4" 036-14

Same as 036-38 with 1/4" male threads.

- 0.07kg



JOINING STUD RA 061RA

Connects 2 Super Clamps 035 at right angles or 45° steps.

- 0.025kg



HEXAGONAL 16MM LIGHTING STUD M10 174

Hexagonal Lighting stud for stirrup's fixture for a rapid connection to a Super Clamp.

- 0.062kg



LIGHTING STUD MR 036MR

Plugs into Super Clamp 035 for lighting fixtures, Grip Heads or connect 2 Super Clamps 035 with 360° rotating capability.

- 0.048kg



ADAPTER SPIGOT 1/4" + 3/8" FEMALE THREADS 119

Universal short 16mm spigot with double female thread 1/4" and 3/8".

- 0.032kg



CAMERA STUD 037

Plugs into Super Clamp 035 socket. To mount cameras, directly or with a camera head. 3/8" and 1/4" threads.

- 0.04kg



DOUBLE FEMALE THREAD STUD 066

Plugs into Super Clamp 035 to provide either a 3/8" or 1/4" female thread fixing.

- 0.025kg



STUD FOR STIRRUP 066BT

16mm stud with female thread M10. It has been specifically designed to mount it on a stirrup's fixture and easily connect it to a Super Clamp. Designed to be tightly lock with a wrench.

- 0.048kg



035 + 237HD + 143BKT

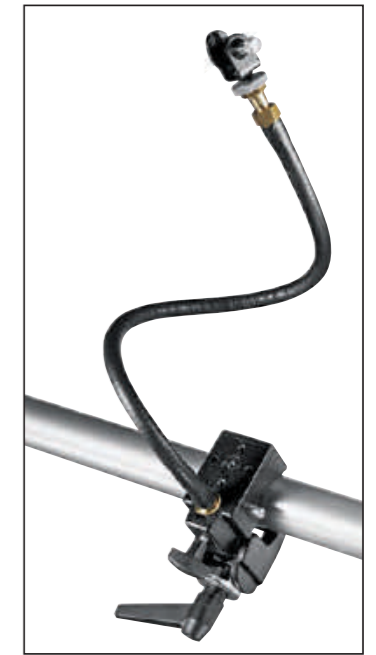

035 + 237 + 196AC

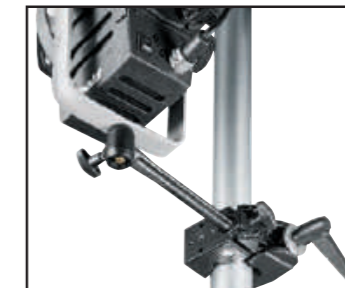

035 + 042



035 X 2 + 061RA



AUTOPOLE® SYSTEM

077 076 032 432-2.7 432-3.7



SHORT SPIGOT ADAPTER 1/4"-3/8" 147

Short spigot adapter 1/4" - 3/8".



0.05kg



SHORT SPIGOT ADAPTER 3/8"-3/8" 125

Short spigot adapter 3/8" - 3/8".



0.05kg



MINI "U" HOOKS 176

Set of two Mini "U" Hooks.



0.1kg



16mm with male spigot



"U" HOOKS 039

Set of two cross bar holders. Width: 40mm



0.16kg



hexagonal 16mm male spigot



OFFSET U HOOK 5039

Set of two Mini "U" Hooks.



0.16kg



40cm



"L" BRACKETS 041

Set of two brackets to use in combination with Super Clamp 035 to support shelves, etc. 17cm long x 4cm deep.



0.29kg



hexagonal 16mm male spigot



EXTENSION ARM 042

Plugs into Super Clamp 035 socket. Length: 19.5cm.



0.21kg



8kg



Type 1



+ Spigot Art. 013



MINI EXTENSION ARM 203

Fits into Mini Clamp 171 socket. Length: 12cm.



0.15kg



5kg



12.5mm hole



SUPER CLAMP WEDGES 035WDG

To allow the Super Clamp 035 to fit on plane surfaces. Set of four.



1.4kg

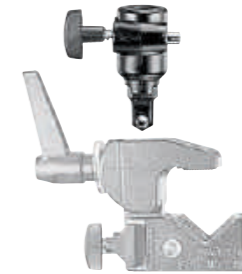

ADDITIONAL SOCKET 335AS

Provides an additional 16mm socket to Super Clamp 035.



0.14kg



SAFETY CABLE C155

Diameter 4mm. Length 100cm.

SAFETY CABLE C155-01

Not illustrated

Diameter 3.5mm. Length 70cm.

SAFETY CABLE C155-02

Not illustrated

Diameter 5mm. Length 70cm.

The mechanical concept on which we based this new range of clamps allows an incredible speed in locking and unlocking the clamp's jaws. Fastening the clamp to a pipe or any other support is quick and simple allowing you to position your lighting equipment securely.

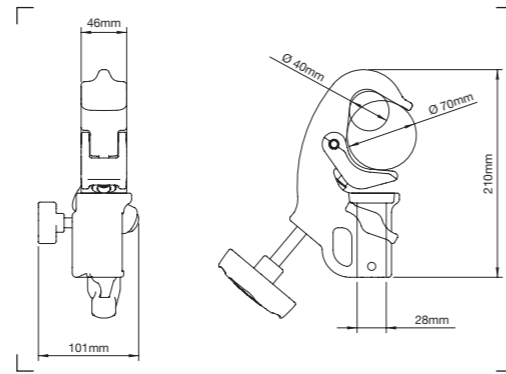

28MM BUSHING QUICK ACTION JUNIOR CLAMP C337

Made in gravity cast aluminium, this clamp is ideal to hang all types of luminaires in TV studios and theaters. Its incredible "coupling range" sets almost no limitations to its capability to clamp to almost all the industry standard pipe diameters. To meet all safety requirements, we have designed a dedicated slot for flexible steel safety cables. Supplied with T-top padded handle to improve grip. Pipe size 40-70mm. PAT. PENDING.

- 1.27kg
- 100kg
- 28mm

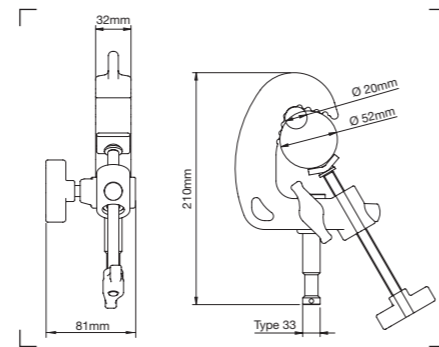

16MM PIN QUICK ACTION BABY CLAMP C338

Very slim and lightweight, this version has been designed for small luminaires, virtually unlimited in application. To meet all safety requirements, we have designed a dedicated slot for flexible steel safety cables. Pipe size 20-52mm. PAT. PENDING.

- 0.76kg
- 50kg
- Type 33

A convenient method of suspending luminaires from above for unobstructed floor areas. Telescopic hangers are renowned for their strength and versatility. Available with either a stirrup or universal head, all hangers come with a safety pin to prevent the riser from slipping.

TELESCOPIC HANGER WITH UNIVERSAL HEAD C825

Max load with 16mm spigot 10kg. Max load with 28mm socket 40kg.

- 121cm
- 201cm
- 5.1kg
- Type 34

TELESCOPIC HANGER WITH STIRRUP C820

Luminaire attachment - Stirrup \varnothing 40mm.

- 117cm
- 197cm
- 5.4kg
- 40kg

TELESCOPIC HANGER WITH UNIVERSAL HEAD C888UH

Max load with 16mm spigot 10kg. Max load with 28mm socket 40kg.

- 78cm
- 161cm
- 4.6kg
- Type 34

LONG TELESCOPIC HANGER WITH UNIVERSAL HEAD C827

Not illustrated

Max load with 16mm spigot 10kg. Max load with 28mm socket 40kg.

- 212cm
- 381cm
- 6.8kg
- Type 34

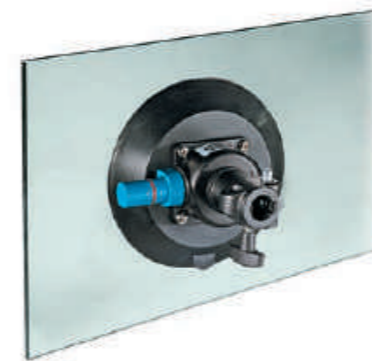

PUMP CUP WITH 16MM SOCKET 241S

A suction cup with a fixed 16mm socket incorporating a safety pin for added security.

- 1.2kg
- 2kg
- 16mm

LONG TELESCOPIC HANGER WITH STIRRUP C822

Not illustrated

Luminaire attachment - Stirrup \varnothing 40mm.

- 210cm
- 379cm
- 6.8kg
- 40kg



PUMP CUP WITH 16MM SWIVEL SOCKET 241

Suction cup for small fixtures and lightweight equipment. \varnothing : 150mm. 16mm bushing with safety pin.

- 1.2kg
- 2kg
- 16mm



Arms



Used in conjunction with stands or clamps, the range of Manfrotto arms, multi positioning arms and attachments enable accurate positioning of lighting and effects. The Magic Arm and the Variable Friction Arm are outstanding, using a single convenient and fast action locking lever or knob to lock or partially lock the two arms and the two swivel studs. Among the most remarkable products in this range are the double articulated arms, enabling quick positioning thanks to their quick lock knobs.

Wherever you need to position your camera, light or accessory, we have an arm to fit the task. Can be combined with clamps, mounting plates and connectors and used in conjunction with virtually any product in the Manfrotto range.

Wherever you need to position your camera, light or accessory, we have an arm, a bracket or a bar to fit the task. Can be combined with clamps, mounting plates and connectors and use in conjunction with virtually any product in the Manfrotto range.







MODEL	PRODUCTS	CODE	MAX LOAD AT FULL EXTENSIONS						
			≤ 0,5 kg	≤ 1 kg	≤ 1,5 kg	≤ 3 Kg	≤ 4,5 Kg	≤ 5 Kg	
Flexible Arm		Flex Arm	237	√ (≤0,3Kg)					
		Heavy Duty Flex Arm	237HD	√					
Mini & Micro Arm		Mini Friciton Arm	244MINI				√		
		Micro Friciton Arm	244MICRO				√		
		Micro Friction Arm With Anti Rotation	244MICRO-AR				√		
		Micro Arm with Arri style adapter	244MICRO-AA				√		
		Micro Friction Arm With Nano Clamp	244MICROKIT				√		
Magic Arm		Magic Arm	143N				√		
		Magic Arm Kit	143				√		
		Magic Arm with Camera Bracket	143A				√		
		Variable Friction Arm	244N				√		
		Variable Friction Arm with Camera Bracket	244				√		
Single Articulated Arm		Single Articulated Arm Top Attachement, 16mm spigot with 3/8" light attachment	196AB-2				√		
		Single Articulated Arm Top Attachement, 16mm spigot with 3/8" light attachment	196AB-3		√				
		Single Articulated Arm Top attachment, camera bracket with 16mm spigot and camera attachemen	196B-2				√		
		Single Articulated Arm Top attachment, camera bracket with 16mm spigot and camera attachment	196B-3		√				
Double Articulated Arm		Double Articulated Arm Top Attachement, 16mm spigot with 3/8" light attachment	396AB-2						√
		Double Articulated Arm Top Attachement, 16mm spigot with 3/8" light attachment	396AB-3					√	
		Double Articulated Arm Top attachment, camera bracket with 16mm spigot and camera attachment	396B-2						√
		Double Articulated Arm Top attachment, camera bracket with 16mm spigot and camera attachment	396B-3					√	

MAX LENGHT cm	ATTACHMENT 1	ATTACHMENT 2	ACCESSORIES
55,0	3/8" female thread with Hexagonal 16 mm	Spigot 5/8" (16 mm) with 1/4" male thread	
24,0	1/4" male thread	1/4" male thread + 3/8" male thread	
15,0	1/4" male thread	1/4" male thread + 3/8" male thread	
15,0	3/8" male thread Anti Rotation	3/8" male thread Anti Anti Rotation + 3/8" attach	
15,0	3/8" male thread Anti Rotation	1/4" male thread + Nano Clamp	
53,0	Spigot 5/8" (16 mm) with 1/4" female thread	Spigot 5/8" (16 mm) with 3/8" female thread	
53,0	Spigot 5/8" (16 mm) with 1/4" female thread	Spigot 5/8" (16 mm) with 3/8" female thread + camera Bracket 143BKT	53 "Camera/Umbrella bracket 143BKT, Super Clamp 035, Backlite Base 003"
53,0	Spigot 5/8" (16 mm) with 1/4" female thread	Spigot 5/8" (16 mm) with 3/8" female thread	Camera/Umbrella bracket 143BKT
53,0	Spigot 5/8" (16 mm) with 1/4" female thread	Spigot 5/8" (16 mm) with 3/8" female thread	
53,0	Spigot 5/8" (16 mm) with 1/4" female thread	Spigot 5/8" (16 mm) with 3/8" female thread	Camera/Umbrella bracket 143BKT
60,5	Spigot 5/8" (16 mm) with 1/4" female thread	Spigot 5/8" (16 mm) with 3/8" female thread	
85,0	Spigot 5/8" (16 mm) with 1/4" female thread	Spigot 5/8" (16 mm) with 3/8" female thread	
60,5	Spigot 5/8" (16 mm) with 1/4" female thread	Spigot 5/8" (16 mm) with 3/8" female thread	Camera/Umbrella bracket 143BKT
85,0	Spigot 5/8" (16 mm) with 1/4" female thread	Spigot 5/8" (16 mm) with 3/8" female thread	Camera/Umbrella bracket 143BKT
62,5	Spigot 5/8" (16 mm) with 3/8" female thread	Spigot 5/8" (16 mm) with Exagon 16mm	
86,0	Spigot 5/8" (16 mm) with 3/8" female thread	Spigot 5/8" (16 mm) with Exagon 16mm	
62,5	Spigot 5/8" (16 mm) with 3/8" female thread	Spigot 5/8" (16 mm) with Exagon 16mm	Camera/Umbrella bracket 143BKT
86,0	Spigot 5/8" (16 mm) with 3/8" female thread	Spigot 5/8" (16 mm) with Exagon 16mm	Camera/Umbrella bracket 143BKT



MAGIC ARM 143N

Articulated arm, without accessories, with centre level to lock all 3 movements. Length: 53cm.

-  1.07kg
-  16mm with 1/4" female attachment
-  3kg
-  16mm with 3/8" female attachment



MAGIC ARM WITH CAMERA BRACKET 143A

Magic Arm with camera bracket only.

-  1.07kg
-  16mm with 1/4" female attachment
-  3kg
-  16mm with 1/4" female attachment
-  16mm with 3/8" female attachment + Camera Bracket Art. 143BKT



VARIABLE FRICTION ARM WITH CAMERA BRACKET 244

Features as 143A, but a large locking knob takes the place of the cam-lever. Variable friction and locking of arm obtained by adjusting knob. Comes complete with Camera/Umbrella Bracket 143BKT only.

-  1.09kg
-  16mm with 1/4" female attachment
-  3kg
-  16mm with 1/4" female attachment
-  16mm with 3/8" female attachment + Camera Bracket Art. 143BKT



MAGIC ARM KIT 143

Articulated arm with centre lever to lock all 3 movements. Length: 53cm. Supplied with: Camera/Umbrella Bracket 143BKT, Super Clamp 035, Backlite Base 003.

-  2.55kg
-  16mm with 1/4" female attachment
-  3kg
-  16mm with 1/4" female attachment
-  16mm with 3/8" female attachment + Camera Bracket Art. 143BKT



VARIABLE FRICTION ARM 244N

Friction Arm with variable friction and locking of arm obtained by adjusting knob.

-  1.09kg
-  16mm with 1/4" female attachment
-  3kg
-  16mm with 1/4" female attachment
-  16mm with 3/8" female attachment



CAMERA/UMBRELLA BRACKET 143BKT

Camera bracket only.



MINI FRICTON ARM 244MINI

24cm friction arm with interchangeable 1/4" attachments and additional 3/8" adapter included.

- 3kg
- 0,44kg



MICRO FRICTON ARM 244MICRO

15cm friction arm with interchangeable 1/4" attachments and additional 3/8" adapter included.

- 3kg
- 0,22kg



FLEX ARM 237

Flexible arm, Ø 13mm, 55cm long with hexagon stud to fit Super Clamp 035 with 3/8" female thread and 16mm stud with 1/4" male thread type 18.

- 0.3kg
- Type 18
- 0.5kg
- 16mm
- Hex 3/8" 1/4" Male



HEAVY DUTY FLEX ARM 237HD

Same as 237, but Ø 18mm.

- 0.3kg
- Type 18
- 0.5kg
- 16mm
- Hex 3/8" 1/4" Male



MICRO FRICTON ARM WITH ANTI ROTATION 244MICRO-AR

15cm friction arm with interchangeable 3/8" Anti-rotation attachments and additional 3/8" adapter included. The Anti-rotation system is compatible with Manfrotto products: Digital Director and 386B-1 Nano Clamp.

- 3kg
- 0,24kg
- 6.6lb
- 0.53lb



MICRO FRICTON ARM WITH NANO CLAMP 244MICROKIT

15cm friction arm with interchangeable 3/8" Anti-rotation attachment and 1/4" attachment and Nano Clamp included. The Anti-rotation system is compatible with Manfrotto products: Digital Director and 386B-1 Nano Clamp.

- 3kg
- 0,31kg
- 6.6lb
- 0.69lb



MICRO ARM WITH ARRI STYLE AND ANTI SLIP ADAPTER 244MICRO-AA

15cm friction arm with interchangeable 3/8" Arri style Anti-rotation Adaptor and 1/4" Anti-slip Adaptor.

- 3kg
- 0,22kg
- 6.6lb
- 0.49lb



DADO MSY0590A

We are introducing Dado, a revolutionary junction that allows a number of attachments to be compatible with our entire range of Manfrotto Lighting clamps and stands. Dado is simple to use, and features an innovative design. Dado comes in two kits: one with 3 tubes, 3 threaded pins and 1 sphere and another one with 6 tubes, 6 threaded pins and 1 sphere.

- 18 threadings (3/8") on the main sphere
- 3 threaded pins (3/8")
- 3 threaded tubes with:
- 3/8" female and 5/8" male attachments
- Weight: 0.23kg



DADO KIT MSY0580A

- 18 threadings (3/8") on the main sphere
- 6 threaded pins (3/8")
- 6 threaded tubes with:
- 3/8" female and 5/8" male attachments
- Weight: 0.37kg



5/8" ADAPTERS 244ADPT58

Two 5/8" adapters accessories compatible with the following friction arms: 244Mini, 244Micro, 244Micro-AR, 244MicroKit.



3/8" AND 1/4" ADAPTERS 244ADPT3814

3/8" and 1/4" adapters accessories compatible with the following friction arms: 244Mini, 244Micro, 244Micro-AR, 244MicroKit.



3/8" ANTI-ROTATION ADAPTER 244ADPT38AR

Anti-rotation adapter accessory compatible with the following friction arms: 244Mini, 244Micro, 244Micro-AR, 244MicroKit. The Anti-rotation system is compatible with Manfrotto products: Digital Director and 386B-1 Nano Clamp.



3/8" ARRI STYLE ANTI-ROTATION ADAPTER 244ADPT38AA

3/8" Arri style Anti-Rotation adapter accessory. Featuring a reversible plate to allow use of the thread without the two location pins. Compatible with 244Mini, 244Micro, 244Micro-AR, 244Micro-AA, 244MicroKit.

1/4" ANTI-SLIP ADAPTER 244ADPT14AS

1/4" Anti-slip adapter accessory. Featuring a 1/4" thread and anti slip rubber. Compatible with 244Mini, 244Micro, 244Micro-AR, 244Micro-AA, 244MicroKit.

Manfrotto broadens its family of articulated arms, providing end users with a versatile and robust range of products with excellent performance.

The new articulated arms have been designed to be compact and lightweight yet offer high loads capacity and optimum arm length in order to guarantee extreme ease of use, practicality and positioning flexibility with improved safety and reliability.



SINGLE ARTICULATED ARMS: 2 & 3 SECTIONS

A more versatile version with telescopic features that make this product even more compact than before. Two available versions – at two and three sections- in order to ensure broad range of length, from 605 to 850mm.

Code	Sections	Top attachment	Bottom attachment	Max length	Max load at full extension	Weight
196AB-2	2	16mm spigot with 3/8" light attachment	16mm spigot (compatible with Super Clamp) with 1/4" thread	605mm	1.5kg	0.4kg
196AB-3	3	16mm spigot with 3/8" light attachment	16mm spigot (compatible with Super Clamp) with 1/4" thread	850mm	1kg	0.5kg
196B-2	2	camera bracket with 16mm spigot and camera attachment	16mm spigot (compatible with Super Clamp) with 1/4" thread	605mm	1.5kg	0.53kg
196B-3	3	camera bracket with 16mm spigot and camera attachment	16mm spigot (compatible with Super Clamp) with 1/4" thread	850mm	1kg	0.63kg



Sliding extensions allow for flexible positioning. Easy to use, even in reduced spaces.

DOUBLE ARTICULATED ARMS: 2 & 3 SECTIONS

Excellent performance: robustness, lightness and versatility... these are the features of the new double articulated arm range. The 396 family has been developed to provide greater robustness than the 196 range and to support heavier loads (up to 5kg), though keeping versatility thanks to its extendable sliding arm system (extends up to 860mm), further enhanced by its quick lock system.

The new bottom attachment adds to the strength and versatility of the 396, with a spigot that combines both a hexagonal part (for anti-rotation fixing to the Super Clamp system) and a universal adapter section (for fitting to a wide range of stands, clamps and accessories).

Code	Sections	Top attachment	Bottom attachment	Max length	Max load at full extensions	Weight
396AB-2	2	16mm spigot with 3/8" light attachment	Double-anchored 16mm hexagonal/universal spigot	625mm	5kg	0.5kg
396AB-3	3	16mm spigot with 3/8" light attachment	Double-anchored 16mm hexagonal/universal spigot	860mm	4.5kg	0.79kg
396B-2	2	camera bracket with 16mm spigot and camera attachment	Double-anchored 16mm hexagonal/universal spigot	625mm	5kg	0.64kg
396B-3	3	camera bracket with 16mm spigot and camera attachment	Double-anchored 16mm hexagonal/universal spigot	860mm	4.5kg	0.9kg



Just turn knob to click-stop and arm position is immediately locked.

Double-anchored spigot with hexagonal (for Super Clamp attachment) & universal (for maximum compatibility) sections. Gives extra strength and anti-rotation rigidity.



Tilt Heads



The Manfrotto Tilt-Heads are a versatile aluminum bracket that will fit on almost any light stand. The perfect tools to tilt and swivel flash heads, LED lights, and cameras.



Made of aluminum and manufactured according to the highest quality standard, Manfrotto tilt heads are extremely reliable and safely hold any photographic equipment.

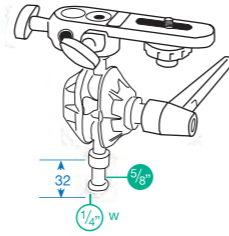



TILT-TOP HEAD **155**

Twin swivelling 16mm spigots and single lever lock. Supplied with: Camera/Umbrella Bracket 143BKT. Height: 14.5cm.

-  0.5kg
-  16mm
-  16mm + Camera Bracket Art. 143BKT

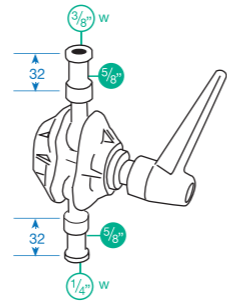

TILT-TOP HEAD **155BKL**

Tilt-top head alone, available separately without Camera/Umbrella Bracket.

-  0.4kg
-  16mm
-  16mm



COLD SHOES TILT HEAD **MLH1HS-2**

Special counterbalance mechanism and unique smart locking ring. Ideal for Speedlights and small LEDs. Locking torque knob for secure tilt functionality.

-  0.2kg
-  5/8" (16mm) socket
-  Cold-Shoe



SWIVELLING ADAPTER **026**

Baby female multi-adapter, free to rotate.

-  17.5mm
-  17.5mm

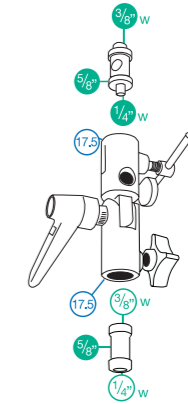

Still Life

Indispensable for all professional still life photographers, Manfrotto Still Life tables are made with lightweight aluminium tubing, dedicated clamps and translucent white Perspex covers for back- or front-lighting of your subject. Their design allows continuous adjustment of the curved backdrop at different angles, making them ideal for product photography. Full modularity makes the table easy to assemble and disassemble. The Manfrotto Still Life line is complete with the well-known Multiclamp system. This extremely flexible and modular system allows you to design and create all sorts of supports that can be easily set up, dismantled and reused for completely different applications. Several accessories will allow you to deal with specific problems.

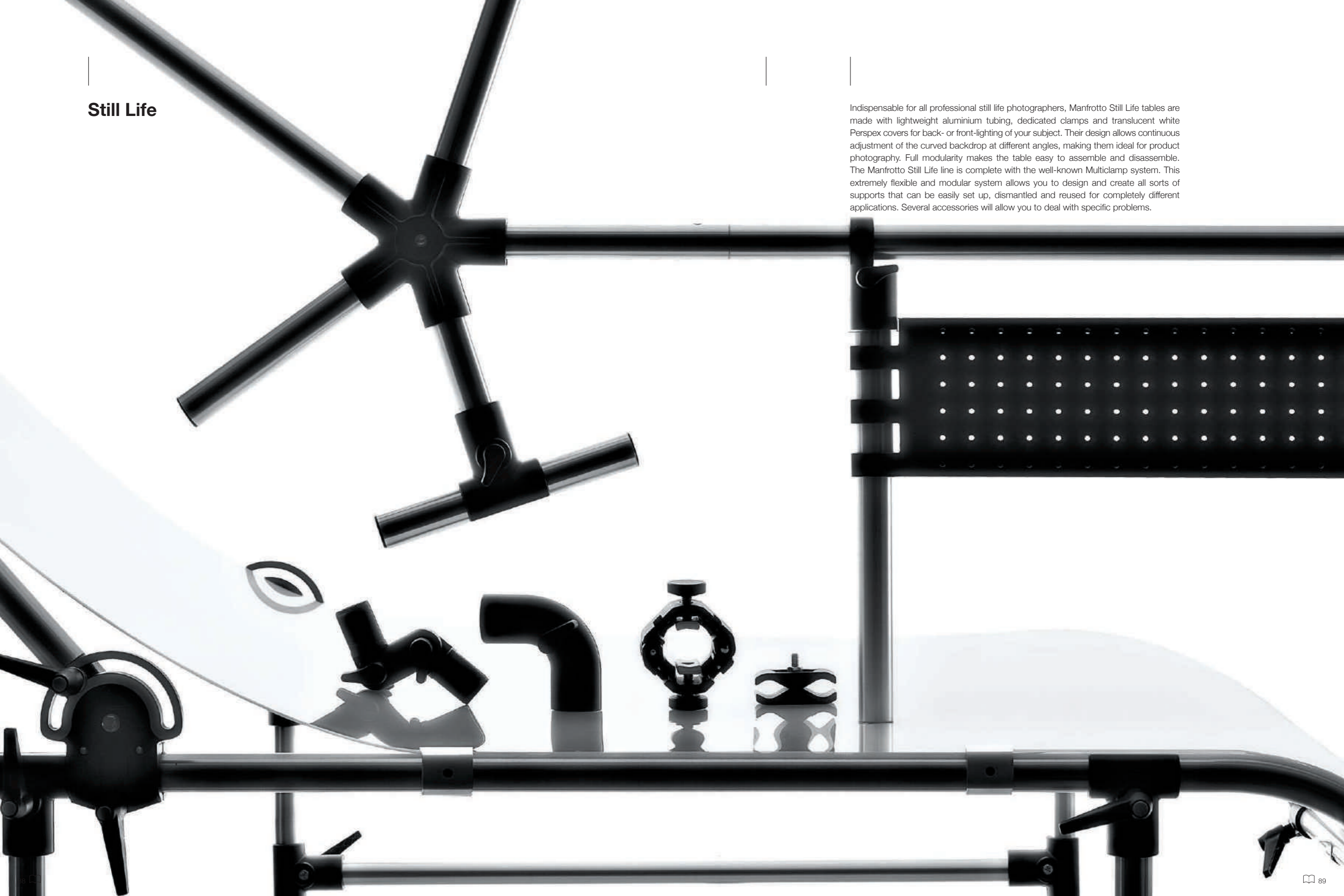

Multi-purpose shooting tables.

Model 220 is fully compatible with the Multiclamp range giving you the possibility to modify and adapt its features to your needs.

Easily assembled/disassembled aluminium structure.



STILL LIFE TABLE 220 B

Still Life Table with white, translucent perspex cover for back or front lighting.
 Size of panel: 200x122cm.
 Distance from floor to flat surface: 83cm.
 Height with back on vertical position: 193cm.
 Adjustable tilting back.



18.6kg



15kg

STILL LIFE TABLE WITHOUT COVER 220PSL B

Not illustrated

Same as 220, without perspex cover.

PERSPEX COVER FOR STILL LIFE TABLE 220PX

Not illustrated

White, translucent perspex cover for back or front lighting.
 Size of panel: 200x122cm.



Quick-change spring clips hold the table cover to the frame.



Adjustable tilting back.



Easy tool-free assembly.



MINI STILL LIFE TABLE 320 B

Smaller version of Still Life Table model 220. Size of panel: 150x78cm.
 Distance from floor to flat surface: 70cm.
 Height with back in vertical position: 157cm.
 Adjustable tilting back and adjustable front legs.



10kg



10kg

MINI STILL LIFE TABLE WITHOUT COVER 320PSL B

Not illustrated

Same as 320, without perspex cover.

PERSPEX COVER FOR MINI STILL LIFE TABLE 320PX

Not illustrated

White, translucent perspex cover for back or front lighting.
 Size of panel: 150x78cm.



Adjustable tilting back.



Easy tool-free assembly.

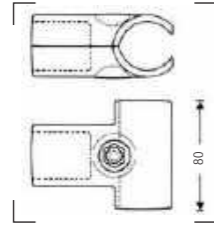

"T" CLAMP MT004

Used like MT001, when a stronger connection is required.

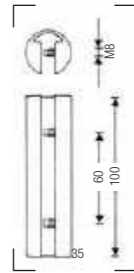

TUBE CONNECTOR MT020

Used to connect two tubes end to end.

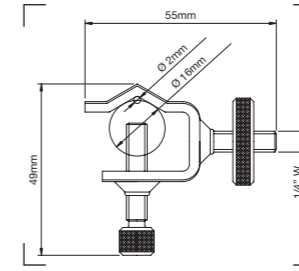

MICRO CLAMP 196AC

Grips items from 2mm to 16mm thick.



0.06kg

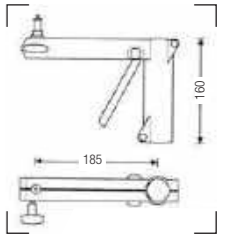

SLIDING SUPPORT ARM 231ARM

Quick release arm, used to mount standard 16mm light fixtures, attachments 16mm female and Spigot 013 (16mm male and 1/4" - 3/8" screws).



WHEEL SET 104

Wheel set Ø: 75mm with brakes and M10 attachment. Set of three.



WHEEL SET 104G

Ø: 100mm without brakes, with M10 attachment. Set of three.

Backgrounds & Backgrounds Support Systems

Our extremely modular background support system is reliable, simple to use and flexible enough to match most of your support needs for paper, drapable, hand-painted or canvas backgrounds, in the studio or on location. For core mounted backgrounds the system used is based on the Expan chain operated drive developed by Manfrotto.

The Expan can be mounted on dedicated hooks which vary in shape and design depending on the number of backgrounds to be used.

If, as usually happens with canvas backgrounds, there is no central core around which to wrap the background material, Manfrotto provides a three section telescopic pole that can be attached on top of a set of two stands, making it ideal for location assignments.



The Manfrotto background support system is based on the Expan, a fast and efficient background drive set. Insert the EXPAN into the background roll, block and use the chain to roll the paper up and down as you wish. A system of hooks is available in pairs and can support 1, 3 or 6 backgrounds when used in conjunction with the Expan. B/P Hooks can be attached to Autopole by using the Super Clamp 035 or screwed directly onto a wall or ceiling.



EXPAN WITH METAL CHAIN 046MC

Background paper drive set for one roll. Including metal chain. Expands from: Ø 46mm to 78mm.

1.2kg

10kg



EXPAN ATTACHMENT 081

Another quick solution to hang your expan up to a baby stand.

0.204kg

Type 1



B/P CLAMPS 044

Same as 045 but ready for use on Autopoles®, including two Super Clamp 035.

2.85kg



B/P SINGLE HOOKS 059WM

Wall fixing background paper holder set for one Expan 046. Complete with screw set.

0.54kg



B/P SINGLE HOOKS 059

Set of two wall fixing background paper holders for one Expan 046. Plugs into Super Clamp 035 socket.

0.42kg



B/P TRIPLE HOOKS 045

Set of two background paper holders for three Expan 046. Can be fixed to a wall with supplied studs and screws, or to Super Clamp 035 by means of supplied screw set.

2.05kg



B/P HOOKS 045-6

Set of two brackets for six Expan 046 sets. To be fixed to a wall with supplied screws.

4.4kg



CHAIN WEIGHT 094

Provides weight to keep Expan chain tight.



0,3kg



EXPAN RED METALLIC CHAIN 091MC

Red Metal chain for Expan system, total length 3,5m



0,6kg



B/P COUNTERWEIGHT 062-2

Counterweight for background paper in 2 sections.
Length: 275cm.



0,85kg



ALU-CORE 047-2

Aluminium core in 2 sections Ø: 50mm for uncored back round paper.
Has adhesive tape for sticking on paper. Length: 275cm.



1,28kg

ALU-CORE 047-3

Not illustrated

Same as 047-2 but longer. Length: 366cm.



1,28kg



SET STANDS KIT 1314B

Designed to support rolls or sheets of background paper or any other ground material.

The kit comprises of:

- 1 x 3 Section Telescopic Pole Art. 272B,
 - 2 x Baby Stand,
 - 2 x Mini Spring Clamp Art. 275 and Transport Kit Bag.
- * distributed on background roll



4,2kg



10kg*



TELESCOPIC POLE 272B

Not illustrated

3 section telescopic background pole on it's own.
Minimum extension: 112cm.
Maximum extension: 298cm.
Weight: 0,85kg.
Attachment: type 25.

Chroma Key FX Background

The Chroma Key FX Background is Manfrotto's all in one portable Chroma Key background solution, tailored to most demanding content creators, videographers and cinematographers working on the move. At an impressive size of 4.2m (13'7") wide and 3m (9'8") tall, the Manfrotto Chroma Key FX background is the largest reusable all in one Chroma Key background kit available. This large working area makes it ideal for use when shooting wide and low camera angles, as well as moving subjects that would otherwise prove unachievable with a smaller surface. The ability to reuse this kit time and time again make this kit an invaluable asset with a return on investment after just one or two uses when compared to a non-re-usable build.



CHROMA KEY FX 4X2.9M BACKGROUND KIT GREEN **MLBG4301KG**

Includes three ultra-fast assembly aluminium frames, one clip on Chroma Key Green cover, four hinge clips, two tensioning bars and one soft carrying bag. Dimensions in bag: Height 30cm, Width 103cm, Depth 30cm. Weight in bag 9.8kg.



9.8kg



CHROMA KEY FX 4X2.9M BACKGROUND COVER BLUE **MLBG4301CB**



CHROMA KEY FX 4X2.9M BACKGROUND KIT BLUE **MLBG4301KB**

Includes three ultra-fast assembly aluminium frames, one clip on Chroma Key Blue cover, four hinge clips, two tensioning bars and one soft carrying bag. Dimensions in bag: Height 30cm, Width 103cm, Depth 30cm. Weight in bag 9.8kg.



9.8kg



CHROMA KEY FX 4X2.9M BACKGROUND COVER GREEN **MLBG4301CG**

Light Control

The Pro Scrim All In Ones are a collection of four lightweight professional light control kits that include all of the essential components required for creative image makers to take control of their lighting set up by bouncing, diffusing and flagging the light source. Included is a lightweight frame, textile covers, grip heads, ears and a carry case. Pro Scrim is available in four different sizes; Small 1.1m x 1.1m (3.6 x 3.6ft), Medium 1.1m x 2m (3.6 x 6.5ft), Large 2m x 2m (6.5 x 6.5ft) and Extra Large 2.9m x 2.9m (9.5ft) all of which effortlessly fold down into their own rigid carry case with an impressive compact folded size of just 102 x 24 x 19cm (40.1 x 9.4 x 7.4in) making it extremely transportable.



PRO SCRIM ALL IN ONE KIT 1.1X1.1M SMALL MLLC1101K

1x lightweight frame, 3x textile covers; (black, double-sided silver/white bounce and 1.25 stop diffuser), 1x grip head and carry case. Dimensions in case: Height 240cm, Width 190cm, Depth 1025cm. Weight in case 5.75kg.



5.75kg



PRO SCRIM ALL IN ONE KIT 1.1X2M MEDIUM MLLC1201K

1x lightweight frame, 3x textile covers; (black, double-sided silver/white bounce and 1.25 stop diffuser), 2x grip heads, 2x ears and carry case. Dimensions in case: Height 240cm, Width 190cm, Depth 1025cm. Weight in bag 7.45kg.



7.45kg



PRO SCRIM ALL IN ONE KIT 2X2M LARGE MLLC2201K

1x lightweight frame, 3x textile covers; (black, double-sided silver/white bounce and 1.25 stop diffuser), 2x grip heads, 2x ears and carry case. Dimensions in case: Height 240cm, Width 190cm, Depth 1025cm. Weight in bag 9.9kg.



9.9kg



PRO SCRIM ALL IN ONE KIT 2.9X2.9M EXTRA LARGE MLLC3301K

1x lightweight frame, 2x textile covers; (black and 1.25 stop diffuser), 2x grip heads, 2x ears and carry case. Dimensions in case: Height 240cm, Width 190cm, Depth 1025cm. Weight in bag 11.4kg.



11.4kg

PRO SCRIM DOPCHOICE 60 DEGREE SNAPGRID®

The Pro Scrim DoPchoice 60 Degree SNAPGRID® is available in two sizes; 2x2m (6.5x6.5ft) and 3x3m (9.8x9.8ft) and compatible with the equivalent Pro Scrim frame size.

The 60-degree fabric grid design provides the user precise control over the spread of light from their Pro Scrim diffuser panel. Ideal for professional content creators wanting to create a controlled dramatic look with a strong directional light and offering minimal spill outside of the subject area, this essential light control tool is the go-to accessory when crafting light on set.

The grid has been designed and created in collaboration with DoPchoice a leading cinema lighting control accessory manufacturer and features their patented instant set-up SNAPFRAMES, which unlike other grids ensure an instant set up and sag-free construction. It attaches to the front of a frame in seconds, using convenient elastic corner straps and secure hook and loop fastenings preventing twisted sections and ensuring even distribution of the fabric grid. Built using strong, hardwearing technical fabric and precisely manufactured to the highest quality standards, these tools are built to be used by even the most demanding professionals and created to last.

In keeping with the ethos of the rest of the Pro Scrim range, these grids are ultra-portable and when it's time to wrap up the shoot the grid simply folds down into the included compact carry case ready for the next shoot with a packed size of just 84x24cm (33x9.4in.).

It's ultra-lightweight too, just 2.2kg (4.8lbs) for the 2x2m and 3.6kg (7.93lbs) for the 3x3m making it an ideal accessory for busy professionals wanting to keep the weight of their kit down to a minimum.



PRO SCRIM DOPCHOICE 60 DEGREE SNAPGRID 2X2 LL LR60SNPGRD22

Aluminium frame.
Dedicated grid for the Skylite Rapid & Pro Scrim.
Rapid attachment and break-down.
DoPchoice's patented SNAPGRID® technology.
Folds down ultra-compact into the included carry case.
Size 2x2m.

 2.2kg



PRO SCRIM DOPCHOICE 60 DEGREE SNAPGRID 3X3 LL LR60SNPGRD33

Aluminium frame.
Dedicated grid for the Skylite Rapid & Pro Scrim.
Rapid attachment and break-down.
DoPchoice's patented SNAPGRID® technology.
Folds down ultra-compact into the included carry case.
Size 3x3m.

 3.6kg



Sky Track System

Ideal for all photo and video studios where the floor needs to be kept totally clear of power cables and lighting stands, the Sky Track System permits rapid manoeuvre and setting of suspended large lights or lights with awkwardly sized accessories like soft boxes.

It solves positioning problems even on complex sets or in studios of the most unusual dimensions, and offers considerable advantages and ease of use compared to traditional floor stands.

Manfrotto Sky Track System has a broad range of accessories to adapt your space to the ideal studio and to provide perfect compatibility with all types of lights, whether photographic, video or film.

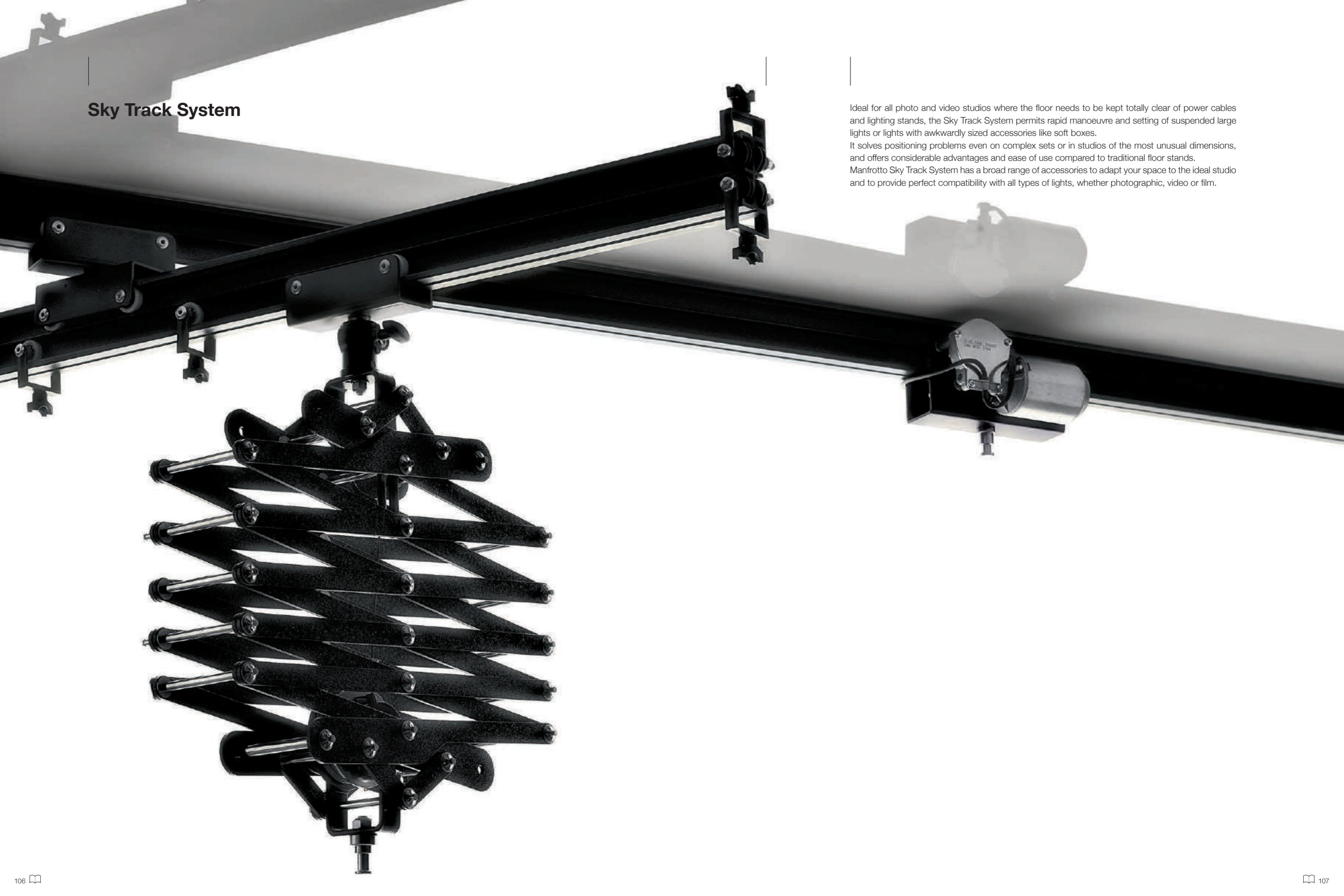

The Sky Track System is a comprehensive range of lighting suspension for all situations from small studios to the largest ones. Manfrotto line includes the versatile ceiling mounted, rails, manual and motorised pantographs and a wide range of brackets and support.



BLACK ANODISED 3M RAIL **FF6003B**

These rails are made in section of black anodised aluminium in standard lengths as listed. For fixed rails, longer sizes are obtainable by fitting two or more rails together. Sliding rails cannot be joined. To connect two fixed rails use code FF320B. You must always support the junction of two rails with a ceiling attachment placed on the junction itself. Moving rails longer than 3m must be supported with more than two fixed rails. The maximum distance (B) between any of these fixed rails is 2m (see drawing).

ANCHORAGE POINT

The spacing of the rail support brackets depends on the load anticipated on the rail itself, but should generally be in accordance with the table below, "A" indicates the distance between two anchorage points. However we advise that fixing brackets should not be spaced more than 2m apart.

BLACK ANODISED 4M RAIL **FF6004B**

Not illustrated

BLACK ANODISED 5M RAIL **FF6005B**

Not illustrated

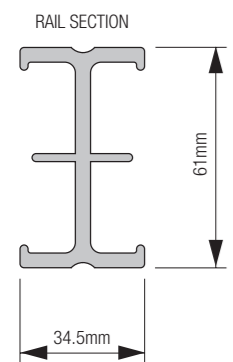
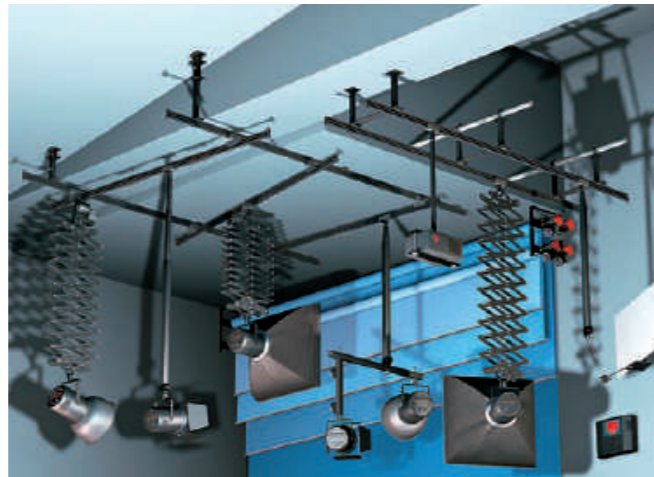

Rail working Max load chart

A (mm)	Weight (kg)
1000	200
1500	100
2000	50

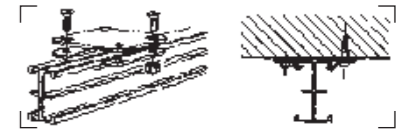
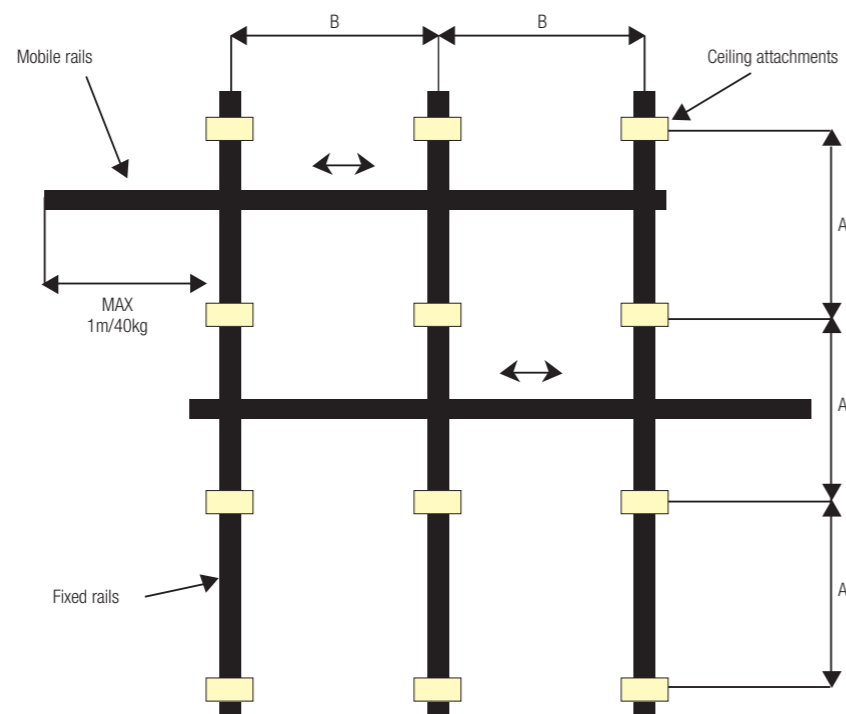

BRACKET FOR CEILING ATTACHMENT **FF3210**

Bracket for ceiling attachment of the rail.

It is advisable to pre-assemble these brackets on the rails at ground level to ensure correct alignment before screwing to a ceiling.

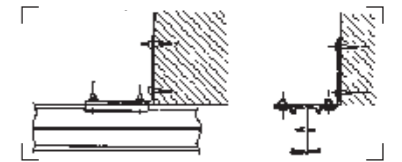

ANGLE BRACKET ("L"-SHAPED) FOR FIXING TO BEAMS **FF3212**

Bracket for wall attachment of the rail.

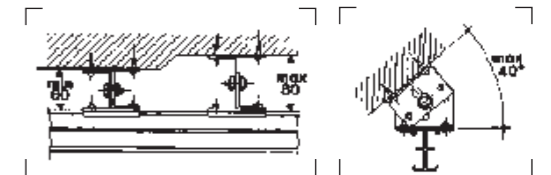

ADJUSTABLE BRACKET FOR IRREGULAR CEILINGS **FF3215**

Allows height differences in ceilings of maximum 2cm; combining two brackets you can compensate for differences of maximum 4cm.

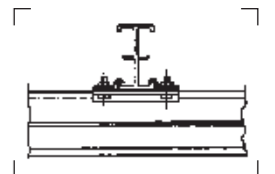

DOUBLE BRACKET FOR RAIL CROSSINGS **FF3211**

This is used to permanently attach two rails at a right angle or parallel.



CEILING BRACKET WITH 50CM EXTENSION **FF3218**

Used alone or in combination these brackets allow the attachment of the rails at the desired height.

CEILING BRACKET WITH 100CM EXTENSION **FF3220**

Not illustrated



EXTENSION BRACKET FOR VARIOUS HEIGHTS **FF3215A**

Its length is adjustable from 10cm to 15.5cm. Using the clamp screw, you can obtain all intermediate sizes. Provided with a security lock, in case the regulating screw loosens, blocks the bracket at maximum extension. It's used to compensate for height differences in ceilings of 5.5cm or more, with combinations of other brackets. It's also used for obtaining intermediate sizes in combination with the extendable ceiling brackets.

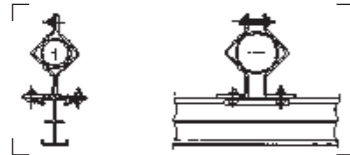

BRACKET FOR TUBE ATTACHMENT **FF3214**

This can be fastened to tubes with diameters from 35mm to 50mm inclusive. It's used to directly support the rail that can be fixed in place either longitudinally or transversely. This bracket can be used as a brace for fixed supports, as well.

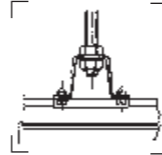

BRACKET FOR CEILING ATTACHMENT **FF3214A**

Can be attached directly by screws or rods with a maximum diameter of 1/2". Before mounting the bracket it is advisable to standardize the length of both the rods and screws. Fix the bracket between a nut allowing the screw on the inside of the bracket to protrude about 1.5cm. When fixture is completed, it is then possible to regulate a perfect rail levelness by adjusting the nuts which fasten the brackets.

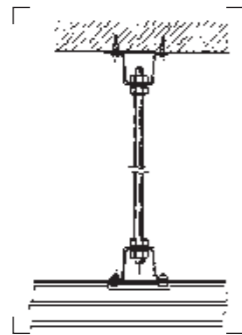

RAIL MOUNTING KIT WITH M12 STUD **FF3214B**

Comprised of a bracket to be attached to the ceiling with 4 screws, a 1m long M12 rod completely threaded, 4 M12 nuts, and a bracket for the rail fixture. The rod can be cut to the desired size and then attached to the bracket by way of the nuts supplied. The rod must protrude approx 1cm on the inside of the bracket. When fixture is completed, it is then possible to regulate a perfect rail levelness by adjusting the nuts which fasten the brackets.

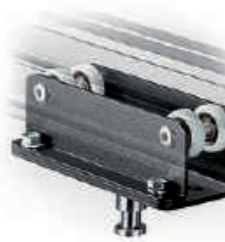

DISMOUNTABLE SLIDING CARRIAGE WITH 4 WHEELS AND 16MM SPIGOT **FF3228**

This carriage can be inserted directly at any point on the rail by unscrewing the wheel plate. This is used when it becomes necessary to add a supplementary carriage to an already assembled RAIL SYSTEM installation. It is free-sliding and is suitable for normal loads.



SLIDING CARRIAGE WITH 4 WHEELS AND 16MM SPIGOT **FF3230**

It is free-sliding carriage. It is suitable for normal weight loads up to 60kg.



SLIDING CARRIAGE WITH 4 WHEELS, BRAKE AND 16MM SPIGOT **FF3229**

This is provided with a brake which keeps it locked in the position where it is placed. It is suitable for normal loads up to 60kg. To release brake pull down on wire with operating pole.



DOUBLE SLIDING CARRIAGE **FF3232**

Both the upper carriage and the lower one are free-sliding.

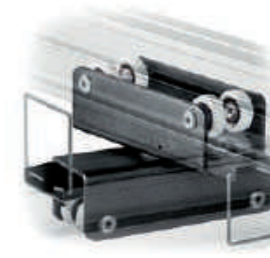

DOUBLE SLIDING CARRIAGE WITH DOUBLE BRAKE **FF3235**

This is equipped with brakes on both upper and lower carriages. The upper brake blocks the carriage on the fixed rail, while the lower carriage's brake blocks the sliding of the moving rail.



DOUBLE SLIDING CARRIAGE WITH ONE BRAKE **FF3236**

This is provided with a brake on only one carriage. Normally, the carriage with brake is mounted on the fixed rail so that it is locked into place enabling the mobile rail to slide. If the carriage with brake is mounted onto the mobile rail, you obtain the opposite effect, that is, the sliding of the mobile rail gets blocked, while the carriage can freely slide on the fixed rail.



FIXED BRACKET ON RAIL WITH 16MM SPIGOT **FF3856**

The 16mm spigot allow the mounting of lights or accessories with 16mm female attachment.



KIT OF 4 END STOPS WITH 4 CABLE CARRIAGES FF3207

These fit to the holes on the ends of a rail to prevent carriages leaving the rail and to prevent moving rails leaving their carriages.
IMPORTANT: must be fitted to upper and lower holes on moving rails but only to lower holes on fixed rails.



ALIGNING CONNECTORS FOR FIXED RAILS FF3208

A pair of clamp plates with screws to join two fixed rails together by clamping across the junction on the upper guide, using holes provided in the rail.
IMPORTANT: the junction must always be supported by a rail-mounting bracket placed astride



KIT OF 5 CABLE CARRIAGES WITH BEARING FF3226C

These are from the end of the rail and run on ball-bearings. They are suitable for heavy cables.



KIT OF 5 CABLE CARRIAGES FF3226

These are inserted from the end of the rail. They do not need wheels as they they slide along the rail and are suitable for normal cables.



OPERATING POLE 427B-4.0

4 sections, 3 risers. Ø: 28, 24, 20, 16mm.
 Minimum extension: 160cm. Maximum extension: 400cm.
 Closed length: 142cm.

OPERATING POLE 427B-6.5

Not illustrated

4 sections, 3 risers. Ø: 28, 24, 20, 16mm.
 Minimum extension: 220cm. Maximum extension: 650cm.
 Closed length: 200cm.



SPIGOT ADAPTER 013

Both sides have 16mm spigot. Used to connect two units with 16mm female attachment or to obtain 16mm spigot from a 16mm female attachment.



16MM FEMALE ADAPTER 158

Both sides have a 16mm attachment. Used to connect two units with 16mm spigot, or to obtain a 16mm female attachment from 16mm spigot.



PANTOGRAPH TOP 4C FF3514N86

The pantograph is made of aluminium (P-Al MgSi UNI 3569) and manufactured according to DIN 15560-46. The attachments at both ends of the pantograph are 16mm, male on the bottom and female on the top. The load is supported by a steel cable of 2mm. diameter (safety factor 12). Loads up to 12kg can be suspended using only the patented friction device, while loads up to a maximum of 18kg require the use of the optional springs. The pantograph can be regulated to keep suspended loads from 1 to 18kg perfectly balanced. By turning the colored notched ring you can adjust the pantograph's friction; this will ensure that the load remains stable when set in position, but that it will move smoothly up and down when necessary. In any case, it is always advisable to use the springs to aid raising your pantograph. When choosing the additional spring(s) for your pantograph, you will first need to know exactly which model of pantograph you have, in order that you can select the spring of the correct length. If you have one of the new compact pantographs (with grey-painted "scissors"), look at the colour of notched ring the 2m version has a red notched ring, while the 3.8m version has a blue notched ring. After having identified the length of the pantograph, choose the appropriate spring(s) by referring to the table below.

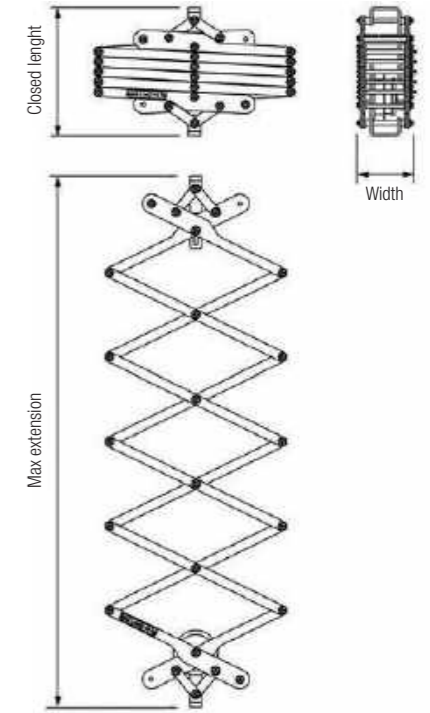

Model	FF3514N86
Lifting rope	2mm wire rope
Safety factor rope	12
Self weight	7.3kg
Max working load	18kg
Closed length	38cm
Max extension	380cm
Width	15cm



Model	FF3512N86
Lifting rope	2mm wire rope
Safety factor rope	12
Self weight	4.7kg
Max working load	18kg
Closed length	27cm
Max extension	200cm
Width	15cm

PANTOGRAPH TOP 2C **FF3512N86**

Same as FF3514N86 but shorter.



SPRING TYPE 4 RED **FF3531**

Additional Spring for pantograph top 2C.



SPRING TYPE 4 BLUE **FF3533**

Additional Spring for pantograph top 4C.

SPRING TYPE 12 RED **FF3532**

Not illustrated

Additional Spring for pantograph top 2C.

SPRING TYPE 12 BLUE **FF3534**

Not illustrated

Additional Spring for pantograph top 4C.

Spring type	Counterbalanced weight
Without spring	From 0kg to 4kg
Type 4	From 3kg to 8kg
Type 4 + Type 4	From 8kg to 14kg
Type12	From 9kg to 16kg
Type 4 + Type 12	From 13kg to 18kg



TELESCOPIC POST EXTENDIBLE FROM 85CM TO 203CM **FF3248**

A telescopic system for the balanced suspension of loads. Adjustable in height with automatic positioning at the desired position. A female attachment with safety plug and locking lever is fitted at each end. The safety plug has a latch with push-button releaselatch with push-button release. To adjust the balance of the load, rotate the handle clockwise or counterclockwise. It sustains loads from 1.5kg up to 12kg max.

SMALL TELESCOPIC POST EXTENDIBLE FROM 60CM TO 128CM **FF3249**

Not illustrated

Same as FF3248, extendable from 60cm to 128cm.



EXTENSION TUBE 50CM LONG **FF3240**

These are fixed extenders which have a female 16mm attachment at each end. You fix them directly on the spigot of single carriages or to the fixed support FF3222.

EXTENSION TUBE 100CM LONG **FF3242**

Not illustrated

Same as FF3240, 100cm long.



SAFETY STEEL CABLE **FF3276**

Complete with spring catch and hook-up slot. Recommended for TELESCOPIC POST and TOP PANTOGRAPH in order to avoid accidental falling of equipment. Ø 2mm - Length 350mm.



TOP SYSTEM 43 **FF3043**

Complete kit for medium-sized studios composed of 2 fixed rails 4m long, 2 mobile rails 3m long and supports for 3 light sources (3 Top Pantographs). The kit is composed of:

- 2 Rails 3m long - FF6003B.
- 2 Rails 4m long - FF6004B.
- 3 Kits of 4 endstops - FF3207.
- 6 Brackets for ceiling fixture - FF3210.
- 3 Kits of 5 cable carriages - FF3226.
- 3 4-wheeled sliding carriages with 16mm spigot - FF3230.
- 2 Double sliding carriages - FF3232.
- 2 Double sliding carriages with single brake - FF3236.
- 3 Top Pantograph extendable from 40cm to 200cm - FF3512N86.
- 3 Safety steel cable - FF3276.

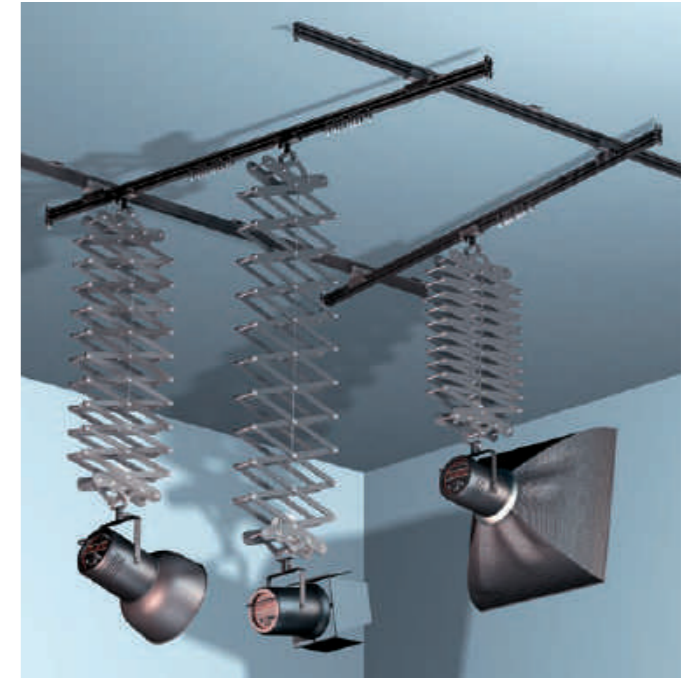
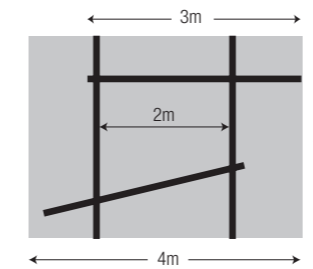

TOP SYSTEM 33 **FF3033**

Complete kit for small studios composed of 2 fixed rails 3m long, 2 mobile rails 3m long and supports for 3 light sources (1 Top Pantograph and 2 Telescopic Post).

The kit is composed of:

- 4 Rails 3m long - FF6003B.
- 3 Kits of 4 endstops - FF3207.
- 6 Brackets for ceiling fixture - FF3210.
- 3 Kits of 5 cable carriages - FF3226.
- 3 4-wheeled sliding carriages with 16mm spigot - FF3230.
- 2 Double sliding carriages - FF3232.
- 2 Double sliding carriages with single brake - FF3236.
- 2 Telescopic Post extendable from 85cm to 203cm - FF3248.
- 1 Top Pantograph extendable from 40cm to 200cm - FF3512N86.
- 2 Universal spigot adapters 16mm - 013.
- 3 Safety steel cable - FF3276.

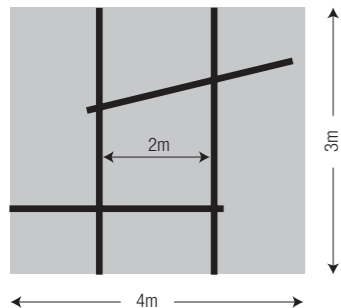

TOP SYSTEM 54 **FF3054**

Complete kit for large studios composed of 2 fixed rails 5m long, 3 mobile rails 3m long and supports for 5 light sources (4 Top Pantographs).

The kit is composed of:

- 2 Rails 5m long - FF6005B.
- 3 Rails 3m long - FF6003B.
- 4 Kits of 4 endstops - FF3207.
- 8 Brackets for ceiling fixture - FF3210.
- 4 Kits of 5 cable carriages - FF3226.
- 4 4-wheeled sliding carriages with 16mm spigot - FF3230.
- 3 Double sliding carriages - FF3232.
- 3 Double sliding carriages with single brake - FF3236.
- 4 Top Pantograph extendable from 40cm to 200cm - FF3512N86.
- 4 Safety steel cable - FF3276.

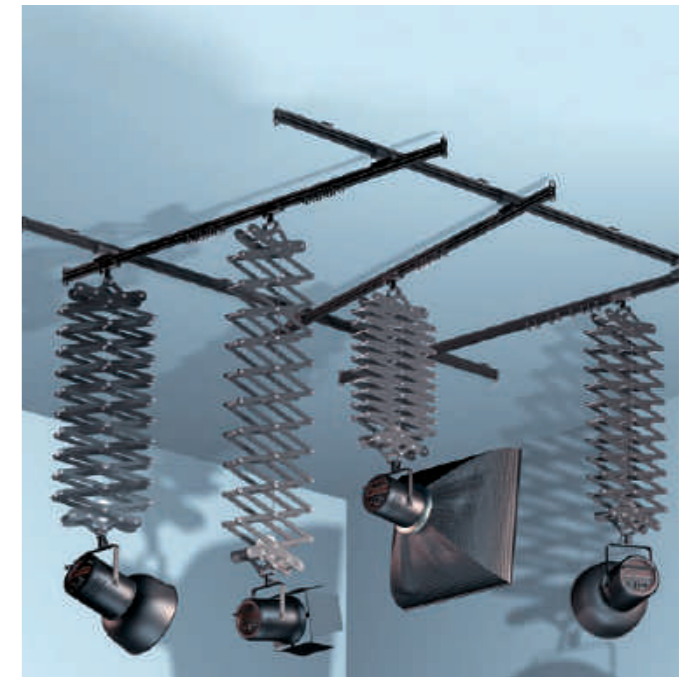
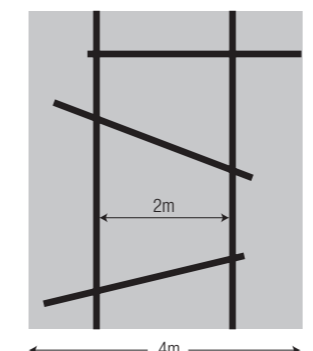

Adapters

MODEL	1/4" W thread Male	1/4" W thread Female	3/8" W thread Male	3/8" W thread Female	Spigot 5/8" Male	Receiver 5/8" Female	Spigot 1 1/8" Male	Hexagon 16 mm Male	Diameter 3/8" Female	Diameter 3/8" Male	Diameter 17mm Male (JP)	M10 Male	M10 Female	M12 Male	Diameter 1/2" Male	Screw for fixings	Other
1/4" W thread Male			013 037 118 147	015 151	013 118 E300	016 194 195 014-14	019-14	037 036-14									
1/4" W thread Female			088 088LBP 148KN	016 066 119	016 119			066	188	149							
3/8" W thread Male	013 037 118 147	088 088LBP 148KN	125	184	013 118 191	179 014-38 014BIM	019 163-38	037 036-38	182								
3/8" W thread Female	015 151	016 066 119	184		016 119 151 186	016		066									
Spigot 5/8" Male	013 118 E300	016 119	013 118 191	016 119 151 186	013 E250	153 159 E100	019 019-14 E200	036-14 036-38 036I 036MR	182 188	192	185	E110	187 066BT			E610	C1000 C1100 E650
Receiver 5/8" Female	016 194 195 014-14		179 014-38 014BIM	016	153 159 E100	158	163-58F		194			014MS			159		152 E390
Spigot 1 1/8" Male	019-14		019 163-38		019 019-14 E200	163-58F						163-10 620-10		163-12 620-12			
Hexagon 16 mm Male	037 036-14	066	037 036-38	066	036-14 036-38 036I 036MR											E620	
Diameter 3/8" Female		188	182		182 188												
Diameter 3/8" Male		149			192	194											
Diameter 17mm Male (JP)					185												
M10 Male					E110	014MS	163-10 620-10										
M10 Female					187 066BT												
M12 Male							163-12 620-12										
Diameter 1/2" Male						159											
Screw for fixings					E610			E620									
Other					C1000 C1100 E650	152 E390											

All Manfrotto adapters provide for a high level of customization, thanks to a wide range that can accept any lighting fixture, in order to match any requirement.



All measurements shown are metric unless otherwise stated.

$\frac{1}{4}''$ Indicates an external thread or stud diameter
 ● Metric ● Imperial
 $\frac{1}{4}''$ Indicates an internal thread or socket diameter
 ● Metric ● Imperial

W: Whitworth thread

5/8" (16MM) FEMALE ADAPTERS

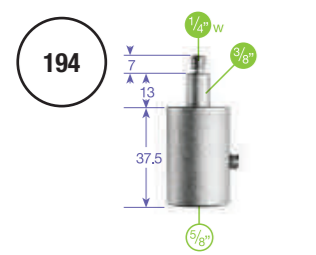
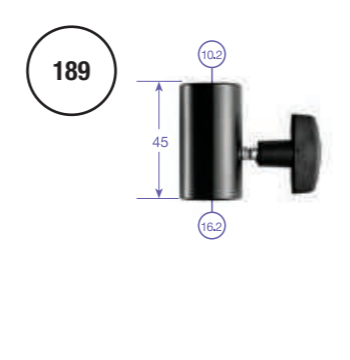
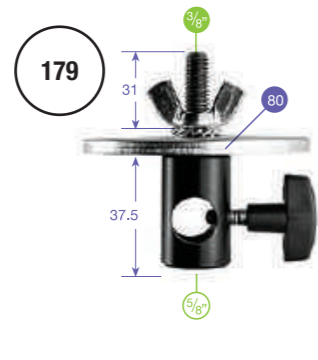
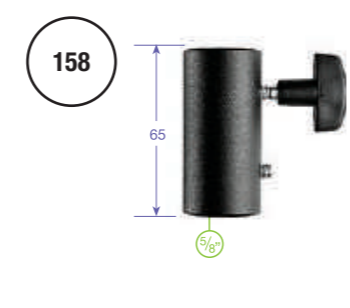
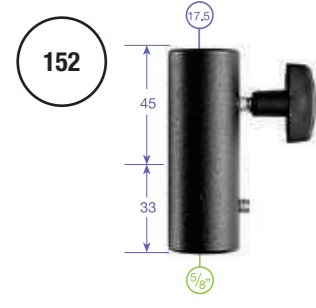
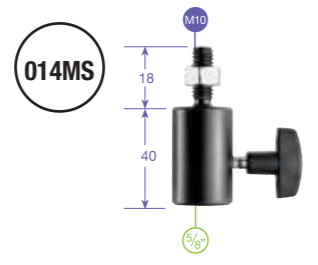
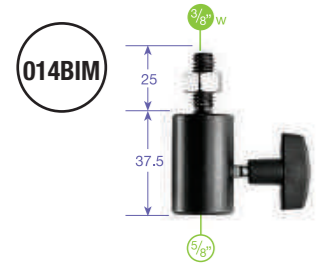
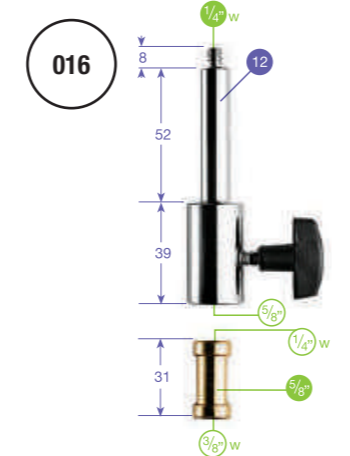
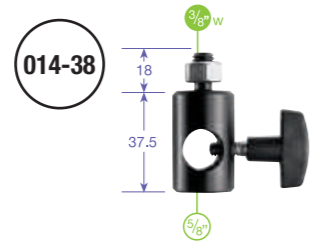
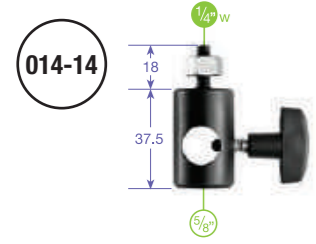

5/8" (16MM) MALE ADAPTERS

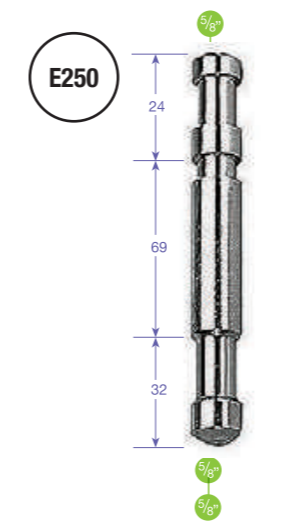
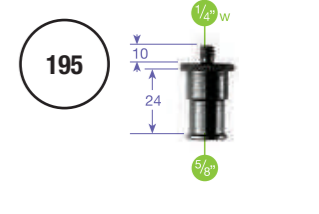
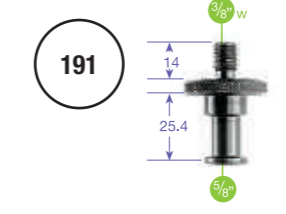
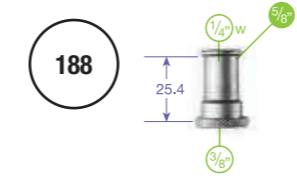
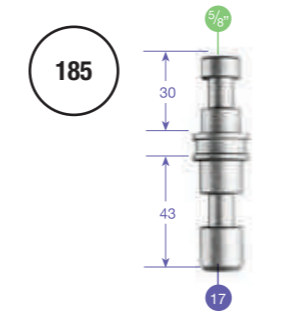
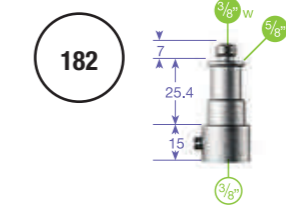
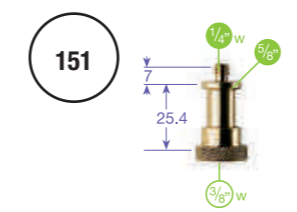
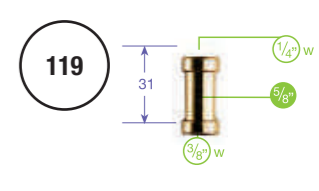
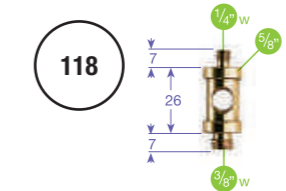
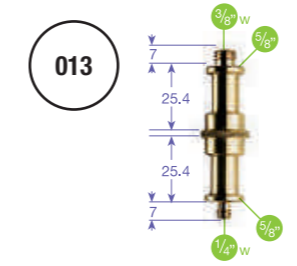

1 1/8 (28MM) MALE ADAPTERS

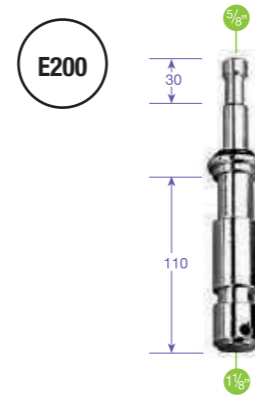
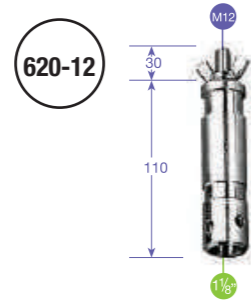
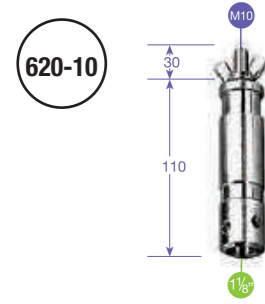
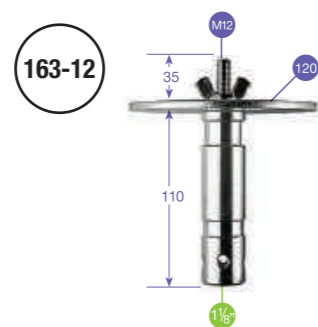
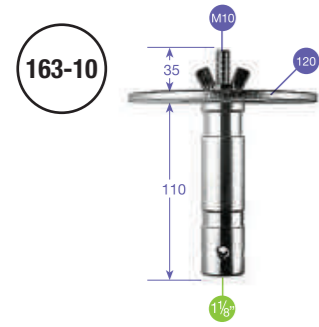

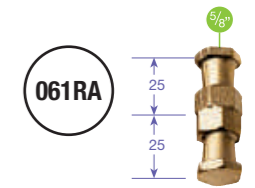
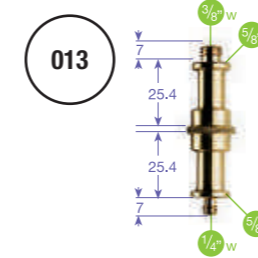

SUPER CLAMP ADAPTERS

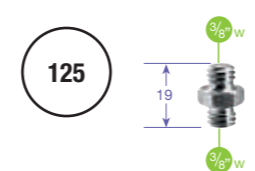
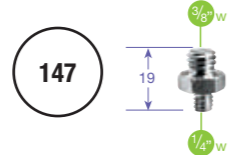
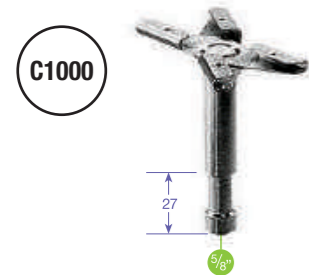
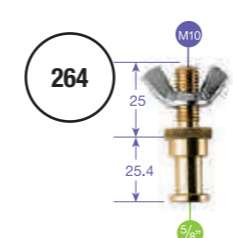
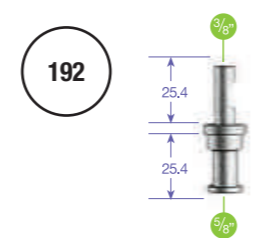
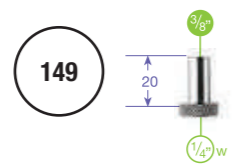
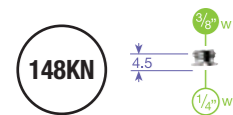
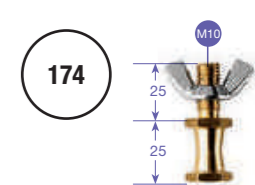
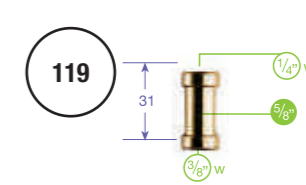
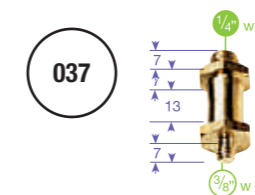
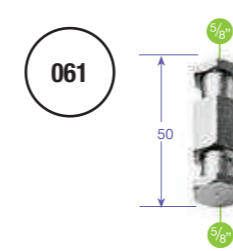
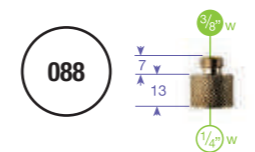
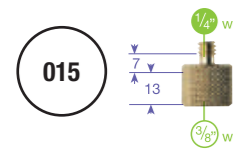

SPECIAL ADAPTERS



Key to symbols

-  Minimum height
-  Maximum height
-  Closed length
-  Footprint diameter
-  Weight
-  Spigot size *
-  Socket size *
-  Suggested wheels
-  Maximum evenly distributed load on level ground
-  Maximum load on fully extended stand at 5° inclination
-  Gravity cast
-  Black
-  Air cushioned

 German Safety Standard

* NOTE: in product specifications you will often see a note referring to the spigot/socket type of the product (e.g. "type 14").

This type number refers to the spigot and socket variants shown on page 118.

Conversions Made Easy (Lengths)

Metric cm	Metric mm	Imperial in.
2.54cm	254mm	1"
1.6cm	16mm	5/8"
2.8cm	28mm	1 1/8"
1.75cm	17.5mm	0.68"
5cm	50mm	1.96"
4cm	40mm	1.57"
100cm	1000mm	39.37"

inches to cm multiply the length by 2.54
cm to inches divide the length by 2.54

Conversions Made Easy (Capacities)

Metric kg	Metric grams	Imperial lbs
1kg	1000g	2.2lbs
2kg	2000g	4.4lbs
10kg	10 000g	22lbs
50kg	50 000g	110lbs
80kg	80 000g	176lbs
100kg	100 000g	220lbs
150kg	150 000g	330lbs

lbs to kg divide the mass by 2.2
kg to lbs multiply the mass by 2.2

This type number refers to the spigot and socket variants shown in product specifications.

 Indicates an external thread or stud diameter
● Metric ● Imperial

 Indicates an internal thread or socket diameter
● Metric ● Imperial

W: Indicates an internal thread or socket diameter

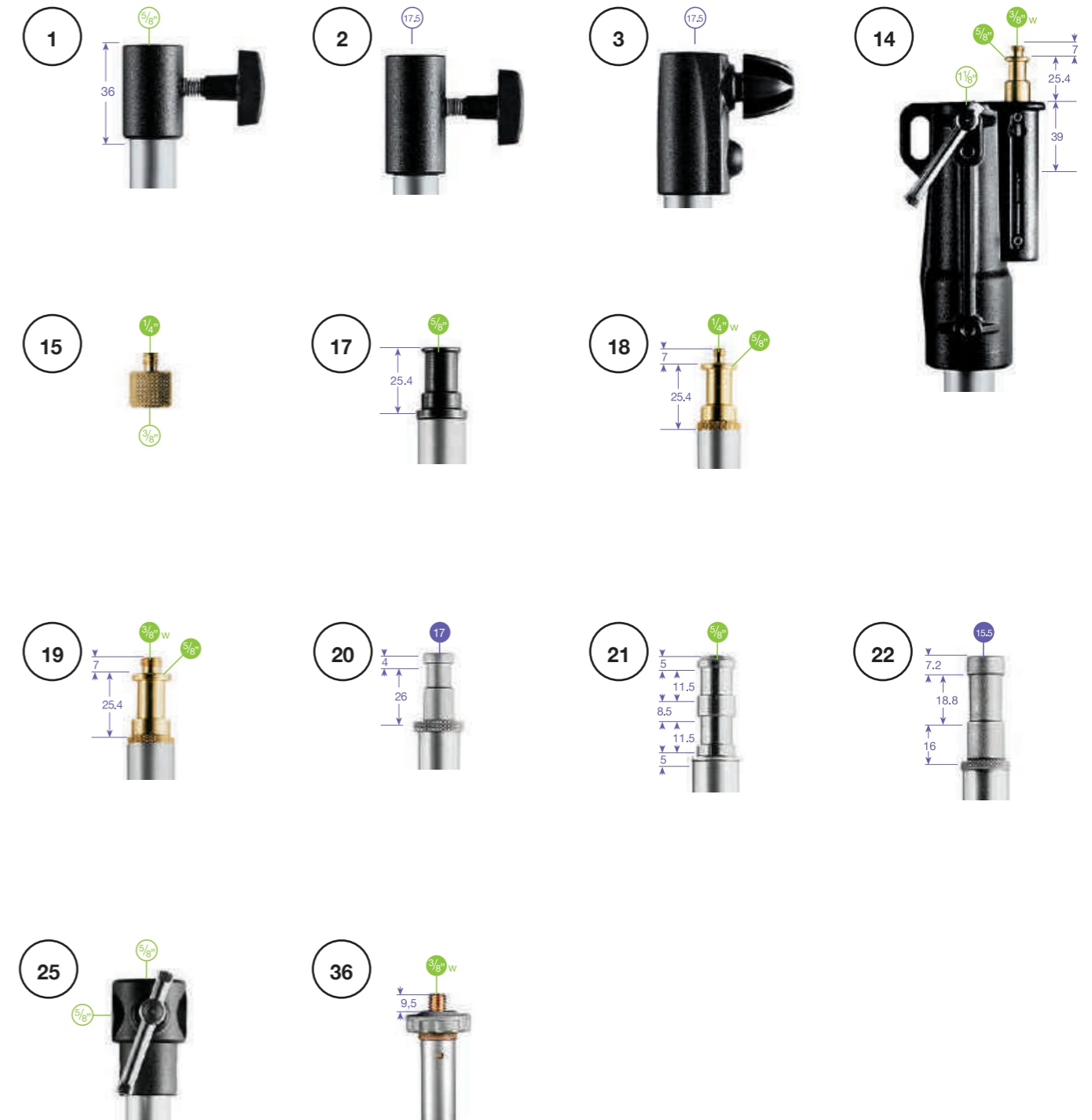

Art. N°	Description	Page	Art. N°	Description	Page
003	BACKLITE BASE	11	076B	BLACK AUTOPOLE	46
003M	MINI BACKLITE BASE MALE ATTACHMENT	11	077	AUTOPOLE	46
003MF	MINI BACKLITE BASE FEMALE ATTACHMENT	11	077B	BLACK AUTOPOLE	46
007BSU	BLACK STEEL SENIOR STAND	14	081	EXPAN ATTACHMENT	32-96
007BU	BLACK ALU SENIOR STAND	14	083NW	STEEL 2 SECTION WIND UP STAND	29
007BUAC	BLACK AIR CUSHIONED ALU SENIOR STAND	14	083NWL	STEEL 2 SECTION LOW BASE WIND UP STAND	27
007CSU	STEEL SENIOR STAND	15	085BS	BLACK LIGHT BOOM 35 (STAND INCLUDED)	39
008BU	BLACK ALU STAND	13	085BSL	BLACK LIGHT BOOM 35 (STAND NOT INCLUDED)	38
008CSU	STEEL JUNIOR STAND	13	087NW	STEEL WIND UP STAND	28
012B	BACKLITE STAND	9	087NWB	BLACK STEEL WIND UP STAND	28
013	SPIGOT ADAPTER	68-118-123	087NWL	STEEL 3 SECTION LOW BASE WIND UP STAND	27
014-14	16MM FEMALE ADAPTER	120	087NWSH	STEEL SHORT WIND UP STAND	29
014-38	16MM FEMALE ADAPTER	120	087WBK	WIND-BRACING KIT	33
014BIM	16MM FEMALE ADAPTER	120	088	SPECIAL ADAPTER	122
014MS	16MM FEMALE ADAPTER	120	091MC	EXPAN RED METALLIC CHAIN	98
015	SPECIAL ADAPTER	122	093	LARGE CABLE CLIP	34
016	16MM FEMALE ADAPTER	120	094	CHAIN WEIGHT	98
017	CASTER WHEEL SET	34	098B	BLACK WALL BOOM (STAND NOT INCLUDED)	40
018	CASTER WHEEL SET	34	098SHB	BLACK SHORT WALL BOOM (STAND NOT INCLUDED)	41
019	SPECIAL ADAPTER	122	1004BAC	BLACK ALU AIR CUSHIONED MASTER STAND	11
022	G-PESO	43	1004BAC-3	BLACK ALU AIR CUSHIONED MINI MASTER STAND	
023	L-PESO	43		IN 3-PACK	11
024B	BLACK LIGHT BOOM (STAND NOT INCLUDED)	40	1005BAC	BLACK ALU AIR CUSHIONED RANKER STAND	11
025BS	BLACK SUPER BOOM (STAND INCLUDED)	39	1005BAC-3	BLACK ALU AIR CUSHIONED MINI RANKER STAND	
025BSL	BLACK SUPER BOOM (STAND NOT INCLUDED)	38		IN 3-PACK	11
025TM	SUPER BOOM WITH COLUMN STAND	40	104	WHEEL SET	35-93
026	SWIVELLING ADAPTER	87	104G	WHEEL SET	35-93
027	STAND HOLDER	33	1051BAC	BLACK ALU AIR CUSHIONED MINI COMPACT STAND	10
032	AUTOPOLE	46	1051BAC-3	BLACK ALU AIR CUSHIONED MINI COMPACT STAND	
032B	BLACK AUTOPOLE	46		IN 3-PACK	10
032BASE	AUTOPOLE BASE	48	1052BAC	BLACK ALU AIR CUSHIONED COMPACT STAND	10
032BASEB	BLACK AUTOPOLE BASE	48	1052BAC-3	BLACK ALU AIR CUSHIONED COMPACT STAND IN 3-PACK	10
032PC	AUTOPOLE PROTECTION CAPS	48	109	WHEEL SET	35
032SPL	AUTOPOLE SPIRIT LEVEL	48	110	WHEEL SET	35
033	EXTENSION TUBE	49	110G	WHEEL SET	35
033B	BLACK EXTENSION TUBE	49	111BSU	BLACK STEEL TALL STAND	15
034	EXTENSION TUBE	49	111CSU	STEEL TALL STAND	16
034B	BLACK EXTENSION TUBE	49	118	SHORT 16MM SPIGOT WITH 1/4"+ 3/8" SCREW	121-123
035	SUPER CLAMP	66	119	ADAPTER SPIGOT 1/4"F + 3/8" F THREADS	121-123
035WDG	SUPER CLAMP WEDGES	71	123	PIVOTING BOOM CLAMP	42
036-14	LIGHTING STUD 1/4"	67-118-123	124	PIVOTING BOOM CLAMP	42
036-38	LIGHTING STUD 3/8"	67-118-123	125	SHORT SPIGOT ADAPTER 3/8"- 3/8"	70-122
036MR	LIGHTING STUD MR	67-118-123	126BSU	BLACK STEEL HEAVY DUTY STAND	16
037	CAMERA STUD	67-118-123	126BSUAC	BLACK STEEL AIR CUSHIONED HEAVY DUTY STAND	16
038	DOUBLE SUPER CLAMP	66	126CSU	STEEL HEAVY DUTY STAND	17
039	"U" HOOKS	70	126CSUAC	STEEL AIR CUSHIONED HEAVY DUTY STAND	17
041	"L" BRACKETS	70	1314B	SET STANDS KIT	99
042	EXTENSION ARM	71	133B	BLACK EXTENSION BAR	67
043	SKY HOOK	62	142B	BLACK ALU STAND EXTENSION	21
044	B/P CLAMPS	97	142CS	STEEL STAND EXTENSION	21
045	B/P TRIPLE HOOKS	97	143	MAGIC ARM KIT	78
045-6	B/P HOOKS	97	143A	MAGIC ARM WITH CAMERA BRACKET	78
046MC	EXPAN WITH METAL CHAIN	96	143BKT	CAMERA/UMBRELLA BRACKET	79
047-2	ALU-CORE	98	143N	MAGIC ARM	78
047-3	ALU-CORE	98	146B	BLACK ALU HIGH STAND EXTENSION	21
059	B/P SINGLE HOOKS	96	146CS	STEEL HIGH STAND EXTENSION	21
059WM	B/P SINGLE HOOKS	96	147	SHORT SPIGOT ADAPTER 1/4" - 3/8"	70-122
061	JOINING STUD	67-123	148KN	SPECIAL ADAPTER	122
061RA	JOINING STUD RA	67-123	149	SPECIAL ADAPTER	122
062-2	B/P COUNTERWEIGHT	98	151	16MM MALE ADAPTER	121
064	SMALL CABLE CLIP	34	152	16MM FEMALE ADAPTER	120
066	DOUBLE FEMALE THREAD STUD	67-123	153	16MM FEMALE ADAPTER	120
066BT	STUD FOR STIRRUP	67-123	154B	THREE BABY BRACKET	32
076	AUTOPOLE	46	155	TILT-TOP HEAD	84

Art. N°	Description	Page	Art. N°	Description	Page
155BKL	TILT-TOP HEAD	86	270CSU	STEEL SUPER STAND	19
156BLB	BLACK ALU LOW MINI PRO STAND	9	271	PANEL CLAMP	63
158	16MM FEMALE ADAPTER	112-120	272B	TELESCOPIC POLE	99
159	16MM FEMALE ADAPTER	120	275	MINI SPRING CLAMP	62
163-10	28MM MALE ADAPTER	122	297BBASE	BLACK LARGE BRAKE BASE	25
163-12	28MM MALE ADAPTER	122	297FBASE	BLACK LARGE FOOT BASE	25
163-38	28MM MALE ADAPTER	122	298B	BLACK ALU STUDIO STAND	24
170	MINI POLE	49	299B	BLACK BABY STUDIO STAND	24
170B	BLACK MINI POLE	49	299BBASE	BLACK SMALL BRAKE BASE	25
171	MINI CLAMP	63	299FBASE	BLACK SMALL FOOT BASE	25
172	MINI COUNTERWEIGHT	43	320	MINI STILL LIFE TABLE	91
173B	BLACK MINI BOOM	42	320B	BLACK MINI STILL LIFE TABLE	91
174	HEXAGONAL 16MM LIGHTING STUD M10	67-123	320PSL	MINI STILL LIFE TABLE WITHOUT COVER	91
175	COLD SHOE SPRING CLAMP	62	320PSLB	BLACK MINI STILL LIFE TABLE WITHOUT COVER	91
175F-2	SPRING CLAMP WITH FLASH SHOE	62	320PX	PERSPEX COVER FOR MINISTILL LIFE TABLE	91
176	MINI "U" HOOKS	70	332-3.7	MINI AUTOPOLE	49
179	16MM FEMALE ADAPTER	120	332-3.7B	BLACK MINI AUTOPOLE	49
182	16MM MALE ADAPTER	121	335AS	ADDITIONAL SOCKET	71
184	16MM MALE ADAPTER	121	374	WHEELS FOR SUPER WIND UP	35
185	16MM MALE ADAPTER	121	374-10	WHEELS FOR SUPER WIND UP	35
186	16MM MALE ADAPTER	121	375	MULTICLIP	62
187	16MM MALE ADAPTER	121	386B-1	NANO CLAMP	66
188	16MM MALE ADAPTER	121	387XBU	BLACK STAINLESS STEEL SUPER WIND UP STAND	31
189	16MM FEMALE ADAPTER	120	387XU	STAINLESS STEEL SUPER WIND UP STAND	30
191	16MM MALE ADAPTER	121	396AB-2	2 SECTION DOUBLE ARTICULATED ARM	83
192	SPECIAL ADAPTER	122	396AB-3	3 SECTION DOUBLE ARTICULATED ARM	83
194	16MM FEMALE ADAPTER	120	396B-2	2 SECTION DOUBLE ARTICULATED ARM	
195	16MM MALE ADAPTER	121		W/CAMERA ATTACHMENT	83
196AB-2	2 SECTION SINGLE ARTICULATED ARM	82	396B-3	3 SECTION DOUBLE ARTICULATED ARM	
196AB-3	3 SECTION SINGLE ARTICULATED ARM	82		W/CAMERA ATTACHMENT	83
196AC	MICRO CLAMP	93	420B	BLACK ALU COMBI-BOOM STAND WITH SANDBAG	37
196B-2	2 SECTION SINGLE ARTICULATED ARM		420CSU	COMBI-BOOM STAND HD	37
	W/CAMERA ATTACHMENT	82	425B	BLACK MEGA BOOM (STAND NOT INCLUDED)	39
196B-3	3 SECTION SINGLE ARTICULATED ARM		427B-4.0	OPERATING POLE	112
	W/CAMERA ATTACHMENT	82	427B-6.5	OPERATING POLE	112
203	MINI EXTENSION ARM	71	432-2.7	AUTOPOLE 2	47
220	STILL LIFE TABLE	90	432-2.7B	BLACK AUTOPOLE 2	47
220B	BLACK STILL LIFE TABLE	90	432-3.7B	BLACK AUTOPOLE 2	47
220PSL	STILL LIFE TABLE WITHOUT COVER	90	5001B-1	BLACK ALU NANO STAND	9
220PSLB	BLACK STILL LIFE TABLE WITHOUT COVER	90	5002BL	NANO PLUS STAND	9
220PX	PERSPEX COVER FOR STILL LIFE TABLE	90	5039	OFFSET U HOOK	70
231ARM	SLIDING SUPPORT ARM	23-93	613PAR	T BAR	32
231B	BLACK ALU COLUMN STAND	23	614	T BAR	32
231CS	STEEL COLUMN STAND	23	620-10	28MM MALE ADAPTER	122
237	FLEX ARM	81	620-12	28MM MALE ADAPTER	122
237HD	HEAVY DUTY FLEX ARM	81	635	QUICK ACTION SUPER CLAMP	66
241	PUMP CUP WITH 16MM SWIVEL SOCKET	73	649	QUICK RELEASE CLAMP	63
241S	PUMP CUP WITH 16MM SOCKET	73	C50EJ	2" END VICE JAW CLAMP	61
244	VARIABLE FRICTION ARM WITH CAMERA BRACKET	80	C50MEJ	2" MICRO END VICE JAW CLAMP	61
244ADPT14AS	1/4" ANTI-SLIP ADAPTER	80	C76CJ	3" CENTRE VICE JAW CLAMP	61
244ADPT38AA	3/8" ARRI STYLE ANTI-ROTATION ADAPTER	80	C100	JUNIOR PIPE CLAMP WITH 28MM SOCKET	63
244ADPT38AR	3/8" ANTI-ROTATION ADAPTER	80	C150	SWIVELLING "C" CLAMP	64
244ADPT58	5/8" ADAPTERS	80	C152EJ	6" END VICE JAW CLAMP	61
244ADPT3814	3/8" AND 1/4" ADAPTERS	80	C155	SAFETY CABLE	71
244MICRO	MICRO FRICTON ARM	80	C155-01	SAFETY CABLE	71
244MICRO-AA	MICRO ARM WITH ARRI STYLE AND ANTI SLIP ADAPTER	80	C155-02	SAFETY CABLE	71
244MICRO-AR	MICRO FRICTON ARM WITH ANTI ROTATION	80	C210	BABY PIPE CLAMP WITH 16MM STUD	65
244MICROKIT	MICRO FRICTON ARM WITH NANO CLAMP	80	C337	28MM BUSHING QUICK ACTION JUNIOR CLAMP	72
244MINI	MINI FRICTON ARM	80	C338	16MM PIN QUICK ACTION BABY CLAMP	72
244N	VARIABLE FRICTION ARM	79	C500	PELICAN GAFFER GRIP	64
264	ROUNDED 16MM LIGHTING STUD M10	67-122	C820	TELESCOPIC HANGER WITH STIRRUP	73
269BU	BLACK ALU SUPER STAND	19	C822	LONG TELESCOPIC HANGER WITH STIRRUP	73
269HDBU	BLACK ALU HIGH SUPER STAND	22	C825	TELESCOPIC HANGER WITH UNIVERSAL HEAD	73
270BSU	BLACK STEEL SUPER STAND	18	C827	LONG TELESCOPIC HANGER WITH UNIVERSAL HEAD	73

Art. N°	Description	Page
C888UH	TELESCOPIC HANGER WITH UNIVERSAL HEAD	73
C1000	SPECIAL ADAPTER	122
C1005	SPECIAL ADAPTER	122
C1100	SPECIAL ADAPTER	122
C1525	SKY HOOK	62
E200	28MM MALE ADAPTER	122
E250	16MM MALE ADAPTER	121
E300	16MM MALE ADAPTER	121
E390	16MM FEMALE ADAPTER	120
E610	SPECIAL ADAPTER	122
E650	16MM MALE ADAPTER	121
FF3033	TOP SYSTEM 33	116
FF3043	TOP SYSTEM 43	117
FF3054	TOP SYSTEM 54	117
FF3207	KIT OF 4 END STOPS WITH 4 CABLE CARRIAGES	112
FF3208	ALIGNING CONNECTORS FOR FIXED RAILS	112
FF3210	BRACKET FOR CEILING ATTACHMENT	109
FF3211	DOUBLE BRACKET FOR RAIL CROSSINGS	109
FF3212	ANGLE BRACKET ("L"-SHAPED) FOR FIXING TO BEAMS	109
FF3214	BRACKET FOR TUBE ATTACHMENT	110
FF3214A	BRACKET FOR CEILING ATTACHMENT	110
FF3214B	RAIL MOUNTING KIT WITH M12 STUD	110
FF3215	ADJUSTABLE BRACKET FOR IRREGULAR CEILINGS	109
FF3215A	EXTENSION BRACKET FOR VARIOUS HEIGHTS	110
FF3218	CEILING BRACKET WITH 50CM EXTENSION	110
FF3220	CEILING BRACKET WITH 100CM EXTENSION	110
FF3226	KIT OF 5 CABLE CARRIAGES	112
FF3226C	KIT OF 5 CABLE CARRIAGES WITH BEARING	112
FF3228	DISMOUNTABLE SLIDING CARRIAGE W/4 WHEELS AND 16MM SPIGOT	110
FF3229	SLIDING CARRIAGE WITH 4 WHEELS, BRAKE AND 16MM SPIGOT	111
FF3230	SLIDING CARRIAGE WITH 4 WHEELS AND 16MM SPIGOT	111
FF3232	DOUBLE SLIDING CARRIAGE	111
FF3235	DOUBLE SLIDING CARRIAGE WITH DOUBLE BRAKE	111
FF3236	DOUBLE SLIDING CARRIAGE WITH ONE BRAKE	111
FF3240	EXTENSION TUBE 50CM LONG	115
FF3242	EXTENSION TUBE 100CM LONG	115
FF3248	TELESCOPIC POST EXTENDABLE FROM 85CM TO 203CM	115
FF3249	SMALL TELESCOPIC POST EXTENDABLE FROM 60CM TO 128CM	115
FF3276	SAFETY STEEL CABLE	115
FF3512N86	PANTOGRAPH TOP 2C	116
FF3514N86	PANTOGRAPH TOP 4C	113
FF3531	SPRING TYPE 4 RED	114
FF3532	SPRING TYPE 12 RED	114
FF3533	SPRING TYPE 4 BLUE	114
FF3534	SPRING TYPE 12 BLUE	114
FF3856	FIXED BRACKET ON RAIL WITH 16MM SPIGOT	111
FF6003B	BLACK ANODISED 3M RAIL	108
FF6004B	BLACK ANODISED 4M RAIL	108
FF6005B	BLACK ANODISED 5M RAIL	108
G100-2	SMALL SAND BAG	33-43
G200-1	LARGE SAND BAG	33-43
G300	EXTRA LARGE SAND BAG	33-43
LL LR60SNPGRD22	PRO SCRIM DOPCHOICE 60 DEGREE SNAPGRID 2x2	105
LL LR60SNPGRD33	PRO SCRIM DOPCHOICE 60 DEGREE SNAPGRID 3x3	105
MC1990A	PICO CLAMP	66
MLBG4301CB	CHROMA KEY FX 4X2.9M BACKGROUND COVER BLUE	101
MLBG4301CG	CHROMA KEY FX 4X2.9M BACKGROUND COVER GREEN	101
MLBG4301KB	CHROMA KEY FX 4X2.9M BACKGROUND KIT BLUE	101
MLBG4301KG	CHROMA KEY FX 4X2.9M BACKGROUND KIT GREEN	101
MLH1HS-2	COLD SHOES TILT HEAD	87
MLLC1101K	PRO SCRIM ALL IN ONE KIT 1.1X1.1M SMALL	105

Art. N°	Description	Page
MLLC1201K	PRO SCRIM ALL IN ONE KIT 1.1X2M MEDIUM	105
MLLC2201K	PRO SCRIM ALL IN ONE KIT 2X2M LARGE	105
MLLC3301K	PRO SCRIM ALL IN ONE KIT 2.9X2.9M EXTRA LARGE	105
MLTSA1001B	TETHERGEAR VESA MONITOR MOUNT	58
MLTSA1201B	TETHERGEAR VESA ADAPTER PLATE	59
MLTSA2001B	TETHERGEAR MOUSE DECK	56
MLTSA3301	TETHERGEAR TABLET HOLDER 9"-13	57
MLTSA4301B	TETHERGEAR LAPTOP DECK	56
MS0490C	CARBON NANOPOLE STAND	9
MS0490A-1	NANO POLE STAND	9
MSY0580A	DADO KIT	81
MSY0590A	DADO	81
MT004	"T" CLAMP	92
MT020	TUBE CONNECTOR	92

